

# HP 5372A

## Frequency and Time Interval Analyzer

OPERATING MANUAL

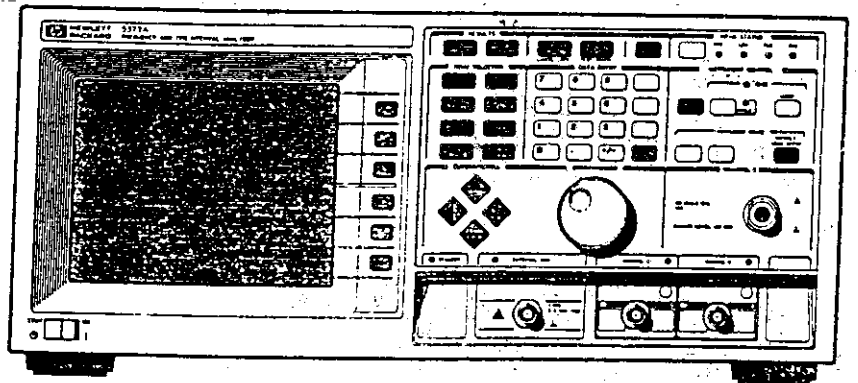

 HEWLETT  
PACKARD



OPERATING MANUAL

# HP 5372A

## Frequency and Time Interval Analyzer

### MANUAL APPLICABILITY

This manual applies directly to an HP 5372A having the serial number prefix listed below. If this number does not match your instrument, refer to the "Manual Updating Changes" included with this manual.

For additional important information about serial numbers, see INSTRUMENTS COVERED BY THIS MANUAL in the Introduction.

#### SERIAL NUMBER

Serial Number Prefix: 2937

Edition 1

E1089

Printed: OCTOBER 1989

---

MANUAL PART NUMBER 05372-90001  
Microfiche Part Number 05372-90002









## Safety Considerations

---

GENERAL	This product and related documentation must be reviewed for familiarization with safety markings and instructions before operation.  This product is a Safety Class I instrument (provided with a protective earth terminal).
BEFORE APPLYING POWER	Verify that the product is set to match the available line voltage and the correct fuse is installed. Refer to instructions in Appendix B of the Operating Manual.
SAFETY EARTH GROUND	An uninterruptible safety earth ground must be provided from the mains power source to the product input wiring terminals or supplied power cable.

## Safety Symbols

---

	Instruction manual symbol; the product will be marked with this symbol when it is necessary for the user to refer to the instruction manual.
	Indicates hazardous voltages.
	Indicates earth (ground) terminal.
 OR 	Indicates terminal is connected to chassis when such connection is not apparent.
	Alternating current.
	Direct current.

**WARNING** \_\_\_\_\_  
**THIS DENOTES A HAZARD. IT CALLS ATTENTION TO A PROCEDURE, PRACTICE, OR THE LIKE, WHICH, IF NOT CORRECTLY PERFORMED OR ADHERED TO, COULD RESULT IN PERSONAL INJURY. DO NOT PROCEED BEYOND A WARNING SIGN UNTIL THE INDICATED CONDITIONS ARE FULLY UNDERSTOOD AND MET.**

---

**CAUTION** \_\_\_\_\_  
**This denotes a hazard. It calls attention to an operating procedure, practice, or the like, which, if not correctly performed or adhered to, could result in damage to or destruction of part or all of the product. Do not proceed beyond a CAUTION sign until the indicated conditions are fully understood and met.**

---

## Safety Information

---

**WARNING** Any interruption of the protective grounding conductor (inside or outside the instrument) or disconnecting the protective earth terminal will cause a potential shock hazard that could result in personal injury. (Grounding one conductor of a two conductor outlet is not sufficient protection.)

Whenever it is likely that the protection has been impaired, the instrument must be made inoperative and be secured against any unintended operation.

If this instrument is to be energized via an autotransformer (for voltage reduction) make sure the common terminal is connected to the earthed pole terminal (neutral) of the power source.

Instructions for adjustments while covers are removed and for servicing are for use by service-trained personnel only. To avoid dangerous electric shock, do not perform such adjustments or servicing unless qualified to do so.

For continued protection against fire, replace the line fuse(s) only with 250V fuse(s) of the same current rating and type (for example, normal blow, time delay). Do not use repaired fuses or short circuited fuseholders.

When measuring power line signals, be extremely careful and always use a step-down isolation transformer whose output voltage is compatible with the input measurement capabilities of this product. This product's front and rear panels are typically at earth ground, so **NEVER TRY TO MEASURE AC POWER LINE SIGNALS WITHOUT AN ISOLATION TRANSFORMER.**





# TABLE OF CONTENTS

---

## Chapter 1 Time Interval Measurements

Chapter Overview .....	1-1
Time Interval Measurements Compared .....	1-2
Normal/Fast Measurement Mode .....	1-2
Time Interval .....	1-3
Continuous Time Interval .....	1-4
± Time Interval .....	1-5
How to Interpret Time Interval Results .....	1-7
Time Interval with Missed Events Example .....	1-7
Continuous Time Interval with Missed Events Example .....	1-11
Time Interval Arming Modes .....	1-16
Measurements Referenced to the Block Arming Edge .....	1-17
Averaged Results for Continuous Time Interval .....	1-18
Time Interval Arming Mode Examples .....	1-18
Time Interval Measurements .....	1-19
Time Interval Measurement with Automatic Arming .....	1-19
Time Interval Measurement with Edge Holdoff Arming .....	1-20
Time Interval Measurement with Time Holdoff Arming .....	1-21
Time Interval Measurement with Event Holdoff Arming .....	1-22
Time Interval Measurement with Interval Sampling Arming .....	1-23
Time Interval Measurement with Repetitive Edge Arming .....	1-24
Time Interval Measurement with Random Sampling Arming .....	1-25
Time Interval Measurement with Edge/Interval Arming .....	1-26
Time Interval Measurement with Edge/Random Arming .....	1-27
Continuous Time Interval Measurements .....	1-28
Continuous Time Interval Measurement with Automatic Arming .....	1-28
Continuous Time Interval Measurement with Edge Holdoff Arming .....	1-29
Continuous Time Interval Measurement with Time Holdoff Arming .....	1-30
Continuous Time Interval Measurement with Event Holdoff Arming .....	1-31
Continuous Time Interval Measurement with Interval Sampling Arming .....	1-32

**Chapter 1**  
**Time Interval**  
**Measurements**  
*(Continued)*

Continuous Time Interval Measurement  
with Repetitive Edge Arming ..... 1-33

Continuous Time Interval Measurement  
with Edge/Interval Arming ..... 1-34

± Time Interval Measurements ..... 1-36

± Time Interval Measurement with Automatic Arming ..... 1-36

± Time Interval Measurement with Edge Holdoff Arming ..... 1-37

± Time Interval Measurement with Interval Sampling Arming .. 1-38

± Time Interval Measurement with Parity Sampling Arming .... 1-39

± Time Interval Measurement with Repetitive Edge Arming .... 1-41

± Time Interval Measurement  
with Repetitive Edge-parity Arming ..... 1-42

± Time Interval Measurement with Random Sampling Arming . 1-44

± Time Interval Measurement with Edge/Interval Arming ..... 1-45

± Time Interval Measurement with Edge/Event Arming ..... 1-47

± Time Interval Measurement with Edge/Parity Arming ..... 1-49

± Time Interval Measurement with Time/Time Arming ..... 1-51

± Time Interval Measurement with Event/Event Arming ..... 1-53

± Time Interval Measurement with Edge/Random Arming ..... 1-55

**Chapter 2**  
**Frequency / Period**  
**Measurements**

Chapter Overview ..... 2-1

How the HP 5372A Measures Frequency and Period ..... 2-1

Time and Events ..... 2-1

A Sample ..... 2-2

Sampling ..... 2-3

When are Samples Taken? ..... 2-3

Sampling Interval ..... 2-5

Deciding How Often To Take Samples ..... 2-6

A Block ..... 2-7

Arming ..... 2-7

Frequency Resolution ..... 2-8

Frequency Range ..... 2-9

Period Range ..... 2-9

Frequency and Period Measurements Described ..... 2-10

Frequency and Period Channel Choices ..... 2-10

Single-Channel ..... 2-11

Two-Channel ..... 2-11



**Appendix E**  
**Specifications**  
*(Continued)*

General .....	E-13
Operating Characteristics .....	E-14
Arming Modes .....	E-14
Holdoff Arming .....	E-14
Sample Arming .....	E-14
Holdoff/Sample Arming .....	E-15
Pre-trigger .....	E-15
Rear Panel Connectors .....	E-15
Gate Outputs 1 and 2 .....	E-15
Arm Delay Outputs 1 and 2 .....	E-16
Inhibit Input .....	E-16
TI Detect Output .....	E-16
Measurement Uncertainty Definitions .....	E-17
Least Significant Digit, Resolution, and Accuracy .....	E-17
Trigger Error and Trigger Level Timing Error .....	E-18
Example Measurements and Uncertainty Calculations .....	E-20
TTL Pulse Width Measurement .....	E-20
ECL Edge-to-Edge, or Single-Period Measurement .....	E-21
ECL Frequency Measurement .....	E-22



## Appendix C Status and Error Messages (Continued)

Error 160: Out of sensitivity cal. ....	C-9
Events occurred which were not timed. ....	C-9
Exponent entry disallowed. ....	C-9
Exponent disallowed due to mantissa. ....	C-9
Gate open. ....	C-10
Graphics not allowed for this meas. ....	C-10
HP 5372A Graphics command no longer used. ....	C-10
Inhibit usage may distort results. ....	C-10
Input line truncated to first 80 chars. ....	C-10
Input parameters may have changed. ....	C-11
Interval sample value changed to 131 ms. ....	C-11
Measurement Aborted. ....	C-11
Measurement Inhibited. ....	C-11
Measurement terminated, no data. ....	C-11
No digits specified, entry aborted. ....	C-12
Non-numeric key ignored. ....	C-12
Not in Talk-only. ....	C-12
Number must be positive. ....	C-12
Numeric entry aborted. ....	C-12
Out of Range: see Meas mode on System menu. ....	C-12
Plot/Print aborted. ....	C-13
Pre-trigger precedes data. ....	C-13
Response timeout occurred. ....	C-13
Result format must be ASCII, see System menu. ....	C-13
Sending output to plotter... ....	C-13
Sending output to printer... ....	C-13
Source channel has changed. ....	C-14
Source, input parameters changed. ....	C-14
Stop Arming precedes Start Arming. ....	C-14
Undefined key. ....	C-14
Value out of range: set to limit. ....	C-14
Value out of range: set to maximum. ....	C-14
Value out of range: set to minimum. ....	C-15
Waiting for arming... ....	C-15
Waiting for input signal... ....	C-15
Waiting for Manual Arm... ....	C-15

**Appendix C**  
**Status and Error**  
**Messages**  
*(Continued)*

Waiting for Pre-trigger... ..C-15  
 Waiting for Start Arming... ..C-15  
 Waiting for Stop Arming... ..C-16  
 WARNING: Both frequencies out of auto-trigger range. ....C-16  
 WARNING: Frequency too high for auto-trigger. ....C-16  
 WARNING: Frequency too low for auto-trigger. ....C-16

**Appendix D**  
**10:1 Probe**  
**Calibration Procedure**

Introduction ..... D-1  
 Equipment Required: ..... D-1  
 Procedure: ..... D-2

**Appendix E**  
**Specifications**

Warranted Specifications ..... E-1  
 Measurement Functions ..... E-1  
     Frequency ..... E-1  
     Period ..... E-2  
     Frequency or Period Ratio ..... E-3  
     Totalize ..... E-3  
     Time Interval ..... E-4  
     Time Deviation ..... E-4  
     Rise Time A and Fall Time A ..... E-5  
     Positive and Negative Pulse Width A ..... E-6  
     Duty Cycle A ..... E-6  
     Phase ..... E-7  
     Phase Deviation ..... E-8  
     Peak Amplitudes A, B ..... E-8  
 Input ..... E-9  
     Channel A and B ..... E-9  
     External Arm ..... E-10  
     Channel C (Option 030 or Option 090) ..... E-11  
 Rear Panel Connectors ..... E-11  
     Frequency Standard External Input ..... E-11  
     Inhibit ..... E-11  
     Option 060 Rear Panel Inputs ..... E-12  
 Time Base ..... E-12  
     Frequency ..... E-12  
     Stability ..... E-12

# Contents of Introduction

---

How to Use This Manual .....	Intro-1
HP 5372A Overview .....	Intro-2
The HP 5372A Key Features .....	Intro-2
Manuals Supplied .....	Intro-3
Accessories Supplied .....	Intro-3
Accessories Available .....	Intro-3
Options Available .....	Intro-4
HP 5372A Specifications .....	Intro-4
Instruments Covered By This Manual .....	Intro-4





**Chapter 17**  
**Performance Tests**  
*(Continued)*

Rear Panel External Arm Input Signal Operating Range Test ..... 17-52  
 Rear Panel External Arm Input Trigger Accuracy Test ..... 17-53  
 Rear Panel External Arm Input Sensitivity and Minimum  
 Pulse Width Test ..... 17-54  
 Channel C Tests ..... 17-55  
     HP 5372A Configuration Setup ..... 17-55  
     Frequency Range/Dynamic Range/Sensitivity Test ..... 17-57  
 HP-IB Verification Program ..... 17-60  
 HP 5372A Performance Test Record ..... 17-67

**Appendix A**  
**Function Menu Guide**

Introduction ..... A-1  
 Overview of Menu Maps ..... A-1

**Appendix B**  
**Unpacking and**  
**Installing**

Introduction ..... B-1  
 Unpacking and Inspection ..... B-1  
 Preparation For Use ..... B-1  
     Operating Environment ..... B-1  
     Bench Operation ..... B-2  
 Power Requirements ..... B-2  
 Line Voltage and Fuse Selection ..... B-3  
     Power Cable ..... B-4  
 Hewlett-Packard Interface Bus (HP-IB) ..... B-6  
     HP-IB Interconnections ..... B-6  
     HP-IB Address Selection ..... B-8  
     HP-IB Descriptions ..... B-8  
 Rack Mounting Kits ..... B-8  
 Storage and Shipment ..... B-9  
     Environment ..... B-9  
     Packaging ..... B-9  
         Original Packaging ..... B-9  
         Other Packaging ..... B-9

**Appendix C**  
**Status and Error**  
**Messages**

Introduction ..... C-1  
 Static Status Messages ..... C-1  
 Momentary Status Messages ..... C-2  
 Momentary Warning Messages ..... C-2  
 Static Error Messages ..... C-2

**Appendix C**  
**Status and Error**  
**Messages**  
*(Continued)*

Static Failure Messages .....	C-2
Error Queue Query Command .....	C-2
Status and Error Message Descriptions .....	C-3
Abort only allowed in Single .....	C-3
Acquiring measurement data .....	C-3
Alternate Timebase selected. Press RESTART. ....	C-3
Arming has changed. ....	C-4
Arming parameter changed. ....	C-4
Arming value changed by Fast Meas mode. ....	C-4
Arming, input parameters changed. ....	C-4
Arming, measurement source have changed. ....	C-4
Binary output turned off. ....	C-5
Block or Measurement size changed. ....	C-5
Calculating measurements. ....	C-5
Decimal point entry disallowed. ....	C-5
Decimal point previously entered. ....	C-5
Enter register number. ....	C-6
Error -100: Unrecognized command. ....	C-6
Error -120: Numeric Argument error. ....	C-6
Error -151: Query not allowed. Binary format. ....	C-6
Error 100: No Listeners on bus. ....	C-6
Error 101: Talker, no listeners. ....	C-6
Error 102: Bus conflict: Talk-only. ....	C-7
Error 103: Key ignored in Remote. ....	C-7
Error 104: Key ignored in LLO. ....	C-7
Error 107: Timebase unlocked. Press RESTART. ....	C-7
Error 108: Ch A and B Overvoltage. ....	C-7
Error 109: Ch A Overvoltage. ....	C-7
Error 110: Ch B Overvoltage. ....	C-8
Error 111: Power-down before removing pods. ....	C-8
Error 130: Only graphs can be plotted. ....	C-8
Error 131: Plot/meas data conflict. ....	C-8
Error 140: Register protected. ....	C-8
Error 141: Register not saved yet. ....	C-8
Error 142: Register out of range. ....	C-9
Error 150: Parameter conflict. ....	C-9



## Chapter 16

### Graphic Results

*(Continued)*

View Channel .....	16-19
Scaling Options .....	16-20
Yscale .....	16-20
Manual Scale X-axis .....	16-21
Manual Scale Y-axis .....	16-21
Autoscale Range Hold .....	16-21
Marker Range Hold .....	16-22
Histogram Graph .....	16-22
Histogram Main Options .....	16-24
Histogram Marker Options .....	16-25
Histogram Zoom Options .....	16-28
Histogram Display Options .....	16-29
Histogram Scaling Options .....	16-33
Limit Lines And Histogram .....	16-37
Time Variation Graph .....	16-37
Time Variation Main Options .....	16-39
Time Variation Marker Options .....	16-40
Time Variation Zoom Options .....	16-45
Time Variation Display Options .....	16-46
Time Variation Scaling Options .....	16-48
Block Averaging and Time Variation Graph .....	16-49
Measurements That Provide Averaged Results .....	16-50
Timing Information .....	16-51
Numeric Screen Timing .....	16-52
Time Variation Graph Timing .....	16-52
Limit Lines on Time Variation .....	16-53
Pre-trigger and Time Variation .....	16-54
Measurement Inhibit on Time Variation .....	16-54
Event Timing Graph .....	16-55
Event Timing Main Options .....	16-57
Event Timing Marker Options .....	16-57
Event Timing Zoom Options .....	16-58
Event Timing Display Options .....	16-59
Event Timing Scaling Options .....	16-59
Preset Values .....	16-59
Saved Parameters .....	16-60

## Chapter 17 Performance Tests

Introduction .....	17-1
Operation Verification .....	17-1
Performance Tests .....	17-1
HP-IB Verification .....	17-1
Equipment Required .....	17-2
Calibration Cycle .....	17-2
Test Record .....	17-2
Operation Verification Procedures .....	17-3
HP 5372A Setup .....	17-3
Power-Up Self Test and Diagnostics .....	17-4
Instrument Control .....	17-5
Measurement Functions .....	17-7
Arming Modes .....	17-9
Input Menu .....	17-11
Measurement Control .....	17-12
HP-IB and Print .....	17-16
Performance Test Procedures .....	17-17
Equipment Preliminary Setup .....	17-18
Channel A and B Tests .....	17-19
HP 5372A Configuration Setup .....	17-19
Channel A and B Frequency and Dynamic Ranges Test .....	17-27
Channel A and B Signal Operating Range Test .....	17-29
Channel A and B Manual Trigger Accuracy Test .....	17-30
Channel A and B Auto Trigger Tests .....	17-33
Channel A and B Sensitivity and Minimum Pulse Width Test (optional) .....	17-36
External Arm Input Tests .....	17-39
HP 5372A Configuration Setup .....	17-39
Front Panel External Arm Input Tests .....	17-43
External Arm Input Frequency and Dynamic Ranges Test .....	17-44
External Arm Input Signal Operating Range Test .....	17-46
External Arm Input Trigger Accuracy Test .....	17-47
External Arm Input Sensitivity and Minimum Pulse Width Test ..	17-48
Rear Panel External Arm Input Tests .....	17-49
Rear Panel External Arm Input Frequency and Dynamic Ranges Test .....	17-49



## Chapter 17 Performance Tests (Continued)

Rear Panel External Arm Input Signal Operating Range Test .....	17-52
Rear Panel External Arm Input Trigger Accuracy Test .....	17-53
Rear Panel External Arm Input Sensitivity and Minimum Pulse Width Test .....	17-54
Channel C Tests .....	17-55
HP 5372A Configuration Setup .....	17-55
Frequency Range/Dynamic Range/Sensitivity Test .....	17-57
HP-IB Verification Program .....	17-60
HP 5372A Performance Test Record .....	17-67

## Appendix A Function Menu Guide

Introduction .....	A-1
Overview of Menu Maps .....	A-1

## Appendix B Unpacking and Installing

Introduction .....	B-1
Unpacking and Inspection .....	B-1
Preparation For Use .....	B-1
Operating Environment .....	B-1
Bench Operation .....	B-2
 Power Requirements .....	B-2
 Line Voltage and Fuse Selection .....	B-3
Power Cable .....	B-4
Hewlett-Packard Interface Bus (HP-IB) .....	B-6
HP-IB Interconnections .....	B-6
HP-IB Address Selection .....	B-8
HP-IB Descriptions .....	B-8
Rack Mounting Kits .....	B-8
Storage and Shipment .....	B-9
Environment .....	B-9
Packaging .....	B-9
Original Packaging .....	B-9
Other Packaging .....	B-9

## Appendix C Status and Error Messages

Introduction .....	C-1
Static Status Messages .....	C-1
Momentary Status Messages .....	C-2
Momentary Warning Messages .....	C-2
Static Error Messages .....	C-2

**Appendix C**  
**Status and Error**  
**Messages**  
*(Continued)*

Static Failure Messages .....	C-2
Error Queue Query Command .....	C-2
Status and Error Message Descriptions .....	C-3
Abort only allowed in Single .....	C-3
Acquiring measurement data .....	C-3
Alternate Timebase selected. Press RESTART. ....	C-3
Arming has changed. ....	C-4
Arming parameter changed. ....	C-4
Arming value changed by Fast Meas mode. ....	C-4
Arming, input parameters changed. ....	C-4
Arming, measurement source have changed. ....	C-4
Binary output turned off. ....	C-5
Block or Measurement size changed. ....	C-5
Calculating measurements. ....	C-5
Decimal point entry disallowed. ....	C-5
Decimal point previously entered. ....	C-5
Enter register number. ....	C-6
Error -100: Unrecognized command. ....	C-6
Error -120: Numeric Argument error. ....	C-6
Error -151: Query not allowed. Binary format. ....	C-6
Error 100: No Listeners on bus. ....	C-6
Error 101: Talker, no listeners. ....	C-6
Error 102: Bus conflict: Talk-only. ....	C-7
Error 103: Key ignored in Remote. ....	C-7
Error 104: Key ignored in LLO. ....	C-7
Error 107: Timebase unlocked. Press RESTART. ....	C-7
Error 108: Ch A and B Overvoltage. ....	C-7
Error 109: Ch A Overvoltage. ....	C-7
Error 110: Ch B Overvoltage. ....	C-8
Error 111: Power-down before removing pods. ....	C-8
Error 130: Only graphs can be plotted. ....	C-8
Error 131: Plot/meas data conflict. ....	C-8
Error 140: Register protected. ....	C-8
Error 141: Register not saved yet. ....	C-8
Error 142: Register out of range. ....	C-9
Error 150: Parameter conflict. ....	C-9

## Chapter 16 Graphic Results (Continued)

View Channel .....	16-19
Scaling Options .....	16-20
Yscale .....	16-20
Manual Scale X-axis .....	16-21
Manual Scale Y-axis .....	16-21
Autoscale Range Hold .....	16-21
Marker Range Hold .....	16-22
Histogram Graph .....	16-22
Histogram Main Options .....	16-24
Histogram Marker Options .....	16-25
Histogram Zoom Options .....	16-28
Histogram Display Options .....	16-29
Histogram Scaling Options .....	16-33
Limit Lines And Histogram .....	16-37
Time Variation Graph .....	16-37
Time Variation Main Options .....	16-39
Time Variation Marker Options .....	16-40
Time Variation Zoom Options .....	16-45
Time Variation Display Options .....	16-46
Time Variation Scaling Options .....	16-48
Block Averaging and Time Variation Graph .....	16-49
Measurements That Provide Averaged Results .....	16-50
Timing Information .....	16-51
Numeric Screen Timing .....	16-52
Time Variation Graph Timing .....	16-52
Limit Lines on Time Variation .....	16-53
Pre-trigger and Time Variation .....	16-54
Measurement Inhibit on Time Variation .....	16-54
Event Timing Graph .....	16-55
Event Timing Main Options .....	16-57
Event Timing Marker Options .....	16-57
Event Timing Zoom Options .....	16-58
Event Timing Display Options .....	16-59
Event Timing Scaling Options .....	16-59
Preset Values .....	16-59
Saved Parameters .....	16-60

## Chapter 17 Performance Tests

Introduction .....	17-1
Operation Verification .....	17-1
Performance Tests .....	17-1
HP-IB Verification .....	17-1
Equipment Required .....	17-2
Calibration Cycle .....	17-2
Test Record .....	17-2
Operation Verification Procedures .....	17-3
HP 5372A Setup .....	17-3
Power-Up Self Test and Diagnostics .....	17-4
Instrument Control .....	17-5
Measurement Functions .....	17-7
Arming Modes .....	17-9
Input Menu .....	17-11
Measurement Control .....	17-12
HP-IB and Print .....	17-16
Performance Test Procedures .....	17-17
Equipment Preliminary Setup .....	17-18
Channel A and B Tests .....	17-19
HP 5372A Configuration Setup .....	17-19
Channel A and B Frequency and Dynamic Ranges Test .....	17-27
Channel A and B Signal Operating Range Test .....	17-29
Channel A and B Manual Trigger Accuracy Test .....	17-30
Channel A and B Auto Trigger Tests .....	17-33
Channel A and B Sensitivity and Minimum Pulse Width Test (optional) .....	17-36
External Arm Input Tests .....	17-39
HP 5372A Configuration Setup .....	17-39
Front Panel External Arm Input Tests .....	17-43
External Arm Input Frequency and Dynamic Ranges Test .....	17-44
External Arm Input Signal Operating Range Test .....	17-46
External Arm Input Trigger Accuracy Test .....	17-47
External Arm Input Sensitivity and Minimum Pulse Width Test ..	17-48
Rear Panel External Arm Input Tests .....	17-49
Rear Panel External Arm Input Frequency and Dynamic Ranges Test .....	17-49



**Chapter 5**  
**Arming**  
*(Continued)*

Edge Sampling .....	5-38
Parity Sampling .....	5-40
Repetitive Edge .....	5-42
Repetitive Edge-Parity .....	5-44
Random Sampling .....	5-46
Holdoff/Sampling Mode .....	5-48
Edge/Interval .....	5-48
Edge/Time .....	5-50
Edge/Edge .....	5-52
Edge/Cycle .....	5-54
Edge/Event .....	5-56
Edge/Parity .....	5-58
Edge/Random .....	5-60
Time/Interval .....	5-62
Time/Time .....	5-64
Event/Interval .....	5-66
Event/Event .....	5-68
Externally Gated .....	5-70
Manual .....	5-72

**Chapter 6**  
**Front Panel /**  
**Rear Panel**

Chapter Overview .....	6-1
Front Panel Organization .....	6-1
Results Area .....	6-1
Menu Selection Area .....	6-2
Data Entry Area .....	6-3
HP-IB Status Area .....	6-4
Local key .....	6-4
RMT LED .....	6-4
LSN LED .....	6-4
TLK LED .....	6-4
SRQ LED .....	6-4
Instrument Control Area .....	6-4
GATE LED .....	6-5
Restart key .....	6-5
Single/Repet key .....	6-5
Manual arm key .....	6-5

**Chapter 6**  
**Front Panel /**  
**Rear Panel**  
*(Continued)*

ABORT function .....	6-6
Immediate Abort .....	6-7
Abort At End Of Block .....	6-7
No Abort Executed .....	6-8
Save key .....	6-8
Recall key .....	6-8
Preset key .....	6-9
Default Meas Setup function .....	6-11
Cursor/Scroll — Entry/Marker Section .....	6-15
Display Screen and Softkey Area .....	6-15
Additional Keys Area .....	6-16
Status key .....	6-16
Print key .....	6-16
Shift key .....	6-16
CANCEL COPY function .....	6-16
PLOT GRAPH function .....	6-17
Power Switch .....	6-17
Power-Up Condition .....	6-17
Front Panel Inputs .....	6-18
 Channel A and Channel B .....	6-18
 External Arm .....	6-18
 Channel C (Option 030 or Option 090) .....	6-19
Rear Panel Features .....	6-20
Line Power Module .....	6-20
HP-IB Connector .....	6-20
Option 060, Rear Panel Inputs .....	6-20
Option 090, Rear Panel Inputs with Channel C .....	6-20
Frequency Standard .....	6-21
External Input .....	6-21
Output .....	6-21
Gate Outputs .....	6-21
Time Interval .....	6-22
Continuous Time Interval .....	6-22
± Time Interval .....	6-22
Frequency and Period .....	6-23
Totalize .....	6-24



**Chapter 4**  
**Histogram**  
**Measurements**  
*(Continued)*

Measurement Acquisition Types .....	4-11
1 Block of N Measurements .....	4-11
M Blocks of N Measurements / Fast Arm .....	4-12
M Blocks of N Measurements / Big Bin .....	4-14
Single Block / Pre-trigger .....	4-16
Multiple Blocks of N Measurements / Pre-trigger .....	4-18
M Blocks of N Measurements / Pre-trigger or # of Meas .....	4-20
1 Block of N Measurements / Pre-trigger or # of Meas .....	4-22
Graph Limits .....	4-24
Boundary Fields .....	4-25
Center .....	4-25
Span .....	4-25
Start .....	4-25
Bin Width .....	4-25
Numeric Results .....	4-27
Main Menu .....	4-28
Set Param / Meas # .....	4-28
Prior Page / Next Page .....	4-28
Formats Menu .....	4-29
WINDOW MARGIN ANALYSIS .....	4-31
Introduction .....	4-31
What Is Window Margin Analysis? .....	4-31
Window Margin Calculations .....	4-34
Data-to-Data Measurements versus Data-to-Clock	
Measurements .....	4-37
The HP 5372A Window Margin Displays and Softkeys .....	4-39
Markers .....	4-39
Softkey Selections .....	4-39
Data-to-Clock Measurements .....	4-41
Configuring the Measurement .....	4-41
Histogram Configuration .....	4-44
Viewing Margin Information .....	4-45
Histogram (Hist) .....	4-46
Window Margin Analysis All (Wma All) .....	4-47
2-sided .....	4-48
Combined .....	4-48
Data-to-Data Measurements .....	4-49

**Chapter 4**  
**Histogram**  
**Measurements**  
*(Continued)*

Configuring the Measurement .....	4-49
Histogram Configuration .....	4-50
Viewing Margin Information .....	4-51
Window Determination .....	4-52
Histogram (Hist) .....	4-53
Window Margin Analysis Multiple Distributions (Wma Mult) .....	4-54
Window Margin Analysis All (Wma All) .....	4-56
2-sided .....	4-56
Combined .....	4-57

**Chapter 5**  
**Arming**

Arming Preview .....	5-1
Time and Events .....	5-1
What Is Arming? .....	5-2
Group vs. Individual Arming .....	5-3
Continuous and Non-Continuous Arming .....	5-5
Continuous or Non-Continuous? .....	5-8
Arming Mode Categories .....	5-8
Automatic Mode .....	5-9
Holdoff Modes .....	5-9
Sampling Modes .....	5-10
Holdoff / Sampling Modes .....	5-10
Function and Arming Mode Summary .....	5-12
Where Arming Fits In .....	5-13
Arming Screen Terms .....	5-15
Detailed Arming Mode Descriptions .....	5-22
Measurements Referenced to the Block Arming Edge .....	5-22
Averaged Results .....	5-23
Automatic Mode .....	5-24
Holdoff Modes .....	5-26
Edge Holdoff .....	5-26
Time Holdoff .....	5-28
Event Holdoff .....	5-30
Sampling Mode .....	5-31
Interval Sampling .....	5-32
Time Sampling .....	5-34
Cycle Sampling .....	5-36

## Chapter 2

### Frequency / Period Measurements

*(Continued)*

Two-Result Measurement .....	2-11
Ratio Measurement .....	2-11
Sum Measurement .....	2-12
Difference Measurement .....	2-12
Frequency and Period Arming Modes .....	2-13
Measurements Referenced to the Block Arming Edge .....	2-14
Averaged Results for Frequency/Period Measurements .....	2-15
Frequency and Period Arming Mode Examples .....	2-15
Frequency Measurement with Automatic Arming .....	2-16
Frequency Measurement with Edge Holdoff Arming .....	2-17
Frequency Measurement with Time Holdoff Arming .....	2-18
Frequency Measurement with Event Holdoff Arming .....	2-19
Frequency Measurement with Interval Sampling Arming .....	2-20
Frequency Measurement with Time Sampling Arming .....	2-21
Frequency Measurement with Cycle Sampling Arming .....	2-22
Frequency Measurement with Edge Sampling Arming .....	2-24
Frequency Measurement with Edge/Interval Arming .....	2-25
Frequency Measurement with Edge/Time Arming .....	2-26
Frequency Measurement with Edge/Edge Arming .....	2-27
Frequency Measurement with Edge/Cycle Arming .....	2-28
Frequency Measurement with Edge/Event Arming .....	2-30
Frequency Measurement with Time/Interval Arming .....	2-32
Frequency Measurement with Time/Time Arming .....	2-34
Frequency Measurement with Event/Interval Arming .....	2-36
Frequency Measurement with Event/Event Arming .....	2-38
Frequency Measurement with Externally Gated Arming .....	2-40

## Chapter 3

### Special-Purpose Measurements

Chapter Overview .....	3-1
Totalize .....	3-1
Totalize Measurements Described .....	3-2
Totalize Channel Choices .....	3-2
Single-Channel .....	3-3
Two-Channel .....	3-3
Two-result Measurement .....	3-3
Ratio Measurement .....	3-3
Sum Measurement .....	3-4

**Chapter 3**  
**Special-Purpose**  
**Measurements**  
*(Continued)*

Difference Measurement ..... 3-4

Totalize Arming Modes ..... 3-5

Totalize Arming Mode Examples ..... 3-6

    Totalize Measurement with Interval Sampling Arming ..... 3-6

    Totalize Measurement with Edge Sampling Arming ..... 3-7

    Totalize Measurement with Edge/Interval Arming ..... 3-8

    Totalize Measurement with Edge/Edge Arming ..... 3-9

    Totalize Measurement with Externally Gated Arming ..... 3-10

    Totalize Measurement with Time/Interval Arming ..... 3-11

    Totalize Measurement with Manual Arming ..... 3-12

Automatic Measurements ..... 3-13

    Rise Time ..... 3-14

    Fall Time ..... 3-16

    Positive Pulse Width ..... 3-18

    Negative Pulse Width ..... 3-20

    Duty Cycle ..... 3-22

    Phase ..... 3-24

    Peak Amplitude ..... 3-28

Phase and Time Deviation Measurements ..... 3-30

    Measurements Referenced to the Block Arming Edge ..... 3-30

    Averaged Results for Phase/Time Deviation Measurements ..... 3-31

    Phase Deviation ..... 3-32

    Time Deviation ..... 3-36

**Chapter 4**  
**Histogram**  
**Measurements**

Chapter Overview ..... 4-1

Information Pointers ..... 4-2

What Are Histogram Measurements? ..... 4-3

Advantages and Limitations of Histogram Measurements ..... 4-3

    Advantages of Histogram Measurements ..... 4-3

    Limitations of Histogram Measurements ..... 4-4

Function Menu ..... 4-5

    Measurement Field ..... 4-5

    Channel Field ..... 4-5

    Issues to Consider ..... 4-5

        How to Avoid Bin Overflow ..... 4-5

        Pre-trigger/TI Detect ..... 4-9

## HOW TO USE THIS MANUAL

This manual is written and organized as a reference manual. It is the most complete source of information on the front-panel operation of the HP 5372A.

To learn the basic operation of the HP 5372A, read the *Getting Started Guide* and then use this manual when you have questions regarding details of the instrument's operation.

To help you find information quickly, this manual is divided into 17 chapters plus five appendices, and the index. In addition to a comprehensive table of contents at the beginning of this book, each chapter is preceded by its own table of contents for easy reference.

The HP 5372A Operating Manual is organized as follows:

- Chapters 1 through 4 describe the measurement functions.
  - Time Interval Measurements
  - Frequency/Period Measurements
  - Special-Purpose Measurements
  - Histogram Measurements
- Chapter 5 discusses arming and provides an example of how each arming mode operates.
  - Arming
- Chapter 6 describes the front and rear panel features.
  - Front Panel/Rear Panel
- Chapters 7 through 14 provide information on each of the menus.
  - Function Menu
  - Input Menu
  - Math Menu
  - Pre-trigger Menu
  - Instrument State Menu
  - System Menu
  - Test Menu
  - Help Menu

- Chapters 15 and 16 describe the numeric and graphic analysis capabilities.
  - Numeric Results
  - Graphic Results
- Chapter 17 provides procedures for operation verification and the testing of the HP 5372A against its specifications.
  - Performance Tests
- Appendices A through E provide additional useful information.
  - A Guide to the Function Menu
  - Unpacking and Installing
  - Status and Error Messages
  - 10:1 Probe Calibration Procedure
  - Specifications

## **HP 5372A OVERVIEW**

The Hewlett-Packard 5372A Frequency and Time Interval Analyzer makes both frequency and time interval measurements at rates of up to 13.3 million measurements-per-second. The 5372A analyzes this data, turning it into useful information by producing statistics, histograms, time variation graphs, and performing limit tests. The 5372A has the unique ability to analyze the dynamics of frequency, time interval, and phase as a function of time. This new representation is called the "modulation domain." The HP 5372A provides full HP-IB programmability, and a powerful set of arming and triggering features which allow you to precisely select signal features to be measured.

## **The HP 5372A Key Features**

The key features include:

- Continuous measurements at up to a 13.3 MHz rate
- DC to 500 MHz frequency range (100 MHz to 2 GHz with optional input channel)
- Histogram measurements using hardware processing for acquiring and analyzing very large sample sizes quickly
- Pre-trigger for frequency and time interval measurements
- Averaging for measurements to increase resolution
- Single-channel phase measurement (Phase Deviation function)

- Cumulative time jitter measurement (Time Deviation function)
- Measurement arming by signal edge, time, events
- - 4.0 to +4.0 second time interval range
- Selection of input pods: 50 $\Omega$ , 1 M $\Omega$ , or 10 k $\Omega$  active probe
- Selectable hysteresis for measurements on noisy signals

## MANUALS SUPPLIED

The following manuals are supplied with the HP 5372A:

- Getting Started Guide
- Operating Manual
- Programming Manual

## ACCESSORIES SUPPLIED

The HP 5372A Frequency and Time Interval Analyzer is supplied with the following:

- Detachable Power Cable
- 2 - HP 54002A BNC Input Pods

The type of power cable supplied depends on the country of destination. Refer to *Table B-1, AC Power Cables Available*, for the part number of the appropriate cable.

## ACCESSORIES AVAILABLE

The following accessories are available for the HP 5372A:

- HP 54001A 10 k $\Omega$ /2pF, 10:1, 1 GHz Miniature Active Probe/Pod
- HP 54002A 50 $\Omega$  BNC Pod
- HP 54003A 1 M $\Omega$ /8pF, 300 MHz Pod with 10:1 Probe
- HP 54300A Pod Multiplexer
- HP J06-59992A Time Interval Calibrator
- HP P/N 1494-0059 Rack Slide-Mount Kit
- HP P/N 05372-67001 Service Support Kit

## **OPTIONS AVAILABLE**

The following options are available for the HP 5372A:

- 020 FastPort
- 030 Channel C
- 060 Rear panel inputs for Channels A, B (50 $\Omega$  BNC), and External Arm (1 M $\Omega$  BNC). No pod selection available with Option 060.
- 090 Option 060 plus rear panel input for Channel C
- 908 Rack mount kit for mounting without front handles
- 910 Additional Getting Started Guide, Operating Manual, and Programming Manual
- 913 Rack mount kit for mounting with front handles
- 915 Service Manual
- 916 Additional Operating Manual and Programming Manual
- W30 Extended Hardware Support provides two additional years of return-to-HP hardware-service support. Option W30 is available only at time of purchase. Service contracts are available from Hewlett-Packard for instruments that did not include Option W30 at time of purchase. For more information, contact your nearest Hewlett-Packard Sales and Support office (offices are listed at the back of this manual.)

## **HP 5372A SPECIFICATIONS**

Instrument specifications are listed in Appendix E, SPECIFICATIONS. These specifications are the performance standards or limits against which the instrument can be tested.

## **INSTRUMENTS COVERED BY THIS MANUAL**

This instrument has a two-part serial number in the form 0000A00000 which is stamped on the serial number plate attached to the rear of the instrument. The first four digits and the letter constitute the serial number prefix and the last five digits form the suffix. The prefix is the same for all identical instruments. It changes only when a change is made to the instrument. The suffix, however, is assigned sequentially and is different for each instrument. This manual applies directly to instruments having the same serial number prefix as listed under SERIAL NUMBER on the title page.



<b>Chapter 11</b>	
<b>Instrument State</b>	
<b>Menu</b>	
<i>(Continued)</i>	
	Reg # ..... 11-2
	Write Protect ..... 11-2
	Description ..... 11-2
	Date/Time Saved ..... 11-2
	Erase Register Data ..... 11-2
	Saved Instrument Parameters ..... 11-3
<b>Chapter 12</b>	
<b>System Menu</b>	
	Chapter Overview ..... 12-1
	HP-IB Configuration ..... 12-2
	Addressing Mode Field ..... 12-2
	Device Address/Print Field ..... 12-2
	Result Format Field ..... 12-3
	Response Timeout Field ..... 12-4
	Options Summary ..... 12-5
	Measurement Mode Field ..... 12-5
	System Clock Field ..... 12-5
	Firmware Revision ..... 12-6
	Display Blank Softkey ..... 12-6
<b>Chapter 13</b>	
<b>Test Menu</b>	
	Chapter Overview ..... 13-1
	Diagnostic Tests ..... 13-2
	Test Screen ..... 13-3
	To Run a Test ..... 13-3
	Power-up Tests ..... 13-4
	User Tests ..... 13-4
	Self Test ..... 13-5
	Time Base Test ..... 13-5
	Input Pods Test ..... 13-5
	Front Panel Test ..... 13-5
<b>Chapter 14</b>	
<b>Help Menu</b>	
	Chapter Overview ..... 14-1
	Help Menu ..... 14-2
<b>Chapter 15</b>	
<b>Numeric Results</b>	
	Chapter Overview ..... 15-1
	Main/Formats Softkey ..... 15-1
	Numeric Format Displays ..... 15-1
	Result Display ..... 15-2

**Chapter 15**  
**Numeric Results**  
*(Continued)*

Set Param/Meas # softkey ..... 15-2

Expanded Data softkey ..... 15-3

Prior Page/Next Page softkeys ..... 15-3

Measurement Scrolling ..... 15-3

Measurement Result Identifiers ..... 15-3

Statistics Display ..... 15-4

    Numeric Parameter field ..... 15-5

Result/Statistics Display ..... 15-5

Limit Status Display ..... 15-6

Bold Display ..... 15-7

    Set Param/Meas # Softkey ..... 15-7

**Chapter 16**  
**Graphic Results**

Chapter Overview ..... 16-1

Menus ..... 16-2

Main Options ..... 16-3

    Active Graph ..... 16-3

    Grid Lines ..... 16-4

    Outline/Connect Data ..... 16-4

    Show Graph ..... 16-5

    Copy Graph ..... 16-6

Marker Options ..... 16-7

    Moving the Markers ..... 16-7

    Scrolling the Graph ..... 16-8

    Marker Selection ..... 16-8

    Marker Orientation ..... 16-9

    Marker Display ..... 16-10

    Marker Next ..... 16-13

    Move Marker to Maximum ..... 16-14

    Move Marker to Minimum ..... 16-14

    Move Inactive Marker to Active Marker ..... 16-15

Zoom Options ..... 16-16

    Zoom In ..... 16-16

    Zoom Out ..... 16-17

    Full Scale ..... 16-17

Display Options ..... 16-18

    Update ..... 16-18

## Chapter 6 Front Panel / Rear Panel (Continued)

Rise/Fall Time, Pos/Neg Pulse Width, Duty Cycle, Phase .....	6-24
Arm Delay Outputs .....	6-25
Automatic .....	6-25
Edge Holdoff .....	6-25
Time Interval .....	6-25
Continuous Time Interval .....	6-26
± Time Interval .....	6-26
Frequency and Period .....	6-26
Inhibit Input .....	6-28
Time Interval Detect .....	6-28
FastPort (Option 020) .....	6-29

## Chapter 7 Function Menu

Chapter Overview .....	7-1
Measurement Field .....	7-2
Channel Field .....	7-3
Block Field and Meas Field .....	7-4
Measurements and Pre-trigger .....	7-6
Measurements with Pre-trigger Off .....	7-7
1 Block of N Measurements .....	7-8
M Blocks of N Measurements / All Results .....	7-10
M Blocks of N Measurements / Not All Results .....	7-12
M Blocks of N Measurements / Averaged Results .....	7-14
Measurements with Pre-trigger On .....	7-15
Single Block of N Measurements / Pre-trigger .....	7-16
Multiple Blocks of N Measurements / Pre-trigger .....	7-18
Arming Mode Field .....	7-19

## Chapter 8 Input Menu

Chapter Overview .....	8-1
Input Channels Field .....	8-2
Trigger Event Fields .....	8-3
Trigger Slope .....	8-4
Trigger Mode .....	8-4
Manual Trigger .....	8-4
Single Auto Trigger .....	8-5
Repetitive Auto Trigger .....	8-5
Trigger Level .....	8-6

<p><b>Chapter 8</b>  <b>Input Menu</b>  <i>(Continued)</i></p>	<p>Trigger Level Numeric Summary ..... 8-7</p> <p>External Arm Level Field ..... 8-7</p> <p>Input Pods ..... 8-7</p> <p style="padding-left: 20px;">Input Pod Characteristics ..... 8-8</p> <p>Bias Level Field ..... 8-8</p> <p>Attenuation Field ..... 8-9</p> <p style="padding-left: 20px;">Channel C (Option 030) Attenuation Field ..... 8-10</p> <p>Hysteresis Field ..... 8-11</p>
<p><b>Chapter 9</b>  <b>Math Menu</b></p>	<p>Chapter Overview ..... 9-1</p> <p>Statistics Field ..... 9-2</p> <p>Math Field ..... 9-5</p> <p style="padding-left: 20px;">Offset Field ..... 9-6</p> <p style="padding-left: 20px;">Normalize Field ..... 9-6</p> <p style="padding-left: 20px;">Scale Field ..... 9-7</p> <p style="padding-left: 20px;">Limits Field ..... 9-8</p> <p>Reference Value ..... 9-9</p> <p>Carrier Frequency Fields ..... 9-11</p> <p>Phase Result Field ..... 9-11</p>
<p><b>Chapter 10</b>  <b>Pre-trigger Menu</b></p>	<p>Chapter Overview ..... 10-1</p> <p>Pre-trigger ..... 10-2</p> <p>Pre-trigger Control ..... 10-3</p> <p style="padding-left: 20px;">Pre-trigger Amount ..... 10-4</p> <p style="padding-left: 20px;">Pre-trigger Event ..... 10-5</p> <p>TI Detect ..... 10-7</p> <p style="padding-left: 20px;">Time Interval Range ..... 10-7</p> <p>Inhibit ..... 10-9</p> <p style="padding-left: 20px;">Inhibit and Arming ..... 10-10</p> <p style="padding-left: 20px;">Inhibit and Pre-trigger ..... 10-11</p> <p style="padding-left: 20px;">Inhibit and Measurement Results ..... 10-11</p> <p style="padding-left: 20px;">Inhibit and Graph Data ..... 10-11</p>
<p><b>Chapter 11</b>  <b>Instrument State</b>  <b>Menu</b></p>	<p>Chapter Overview ..... 11-1</p> <p>Instrument State Menu ..... 11-2</p> <p style="padding-left: 20px;">Save/Recall a Setup ..... 11-2</p>

An instrument manufactured after the printing of this manual may have a serial number prefix that is not listed on the title page. These unlisted numbers indicate that the instrument is different from that documented in this manual. The manual for this newer instrument is accompanied by a "Manual Updating Changes" supplement. This supplement contains information that explains how to adapt the manual to the newer instrument.

In addition to change information, the supplement may contain information for correcting errors in the manual. To keep this manual as current and accurate as possible, Hewlett-Packard recommends that you periodically request the latest Manual Updating Changes. The supplement for this manual is identified with the manual print date and part number, both of which appear on the manual title page. Complimentary copies of the supplement are available from Hewlett-Packard. For information concerning a serial number prefix that is not listed on the title page or the Manual Changes supplement, contact your nearest Hewlett-Packard Sales and Support Office.

Listed on the title page is the part number for a microfiche version of the Operating Manual. This number can be used to order 100 × 150 mm (4 × 6 inch) microfilm transparencies of the manual. Each microfiche contains up to 96 photo-duplicates of the manual pages.



XXXXXXXXXXXX

TEMPERATURE  
MEASUREMENTS





## Contents of Chapter

---

Chapter Overview .....	1-1
Time Interval Measurements Compared .....	1-2
Normal/Fast Measurement Mode .....	1-2
Time Interval .....	1-3
Continuous Time Interval .....	1-4
$\pm$ Time Interval .....	1-5
How to Interpret Time Interval Results .....	1-7
Time Interval with Missed Events Example .....	1-7
Continuous Time Interval with Missed Events Example .....	1-11
Time Interval Arming Modes .....	1-16
Measurements Referenced to the Block Arming Edge .....	1-17
Averaged Results for Continuous Time Interval .....	1-18
Time Interval Arming Mode Examples .....	1-18
Time Interval Measurements .....	1-19
Time Interval Measurement with Automatic Arming .....	1-19
Time Interval Measurement with Edge Holdoff Arming .....	1-20
Time Interval Measurement with Time Holdoff Arming .....	1-21
Time Interval Measurement with Event Holdoff Arming .....	1-22
Time Interval Measurement with Interval Sampling Arming .....	1-23
Time Interval Measurement with Repetitive Edge Arming .....	1-24
Time Interval Measurement with Random Sampling Arming .....	1-25
Time Interval Measurement with Edge/Interval Arming .....	1-26
Time Interval Measurement with Edge/Random Arming .....	1-27
Continuous Time Interval Measurements .....	1-28
Continuous Time Interval Measurement with Automatic Arming .....	1-28
Continuous Time Interval Measurement with Edge Holdoff Arming .....	1-29
Continuous Time Interval Measurement with Time Holdoff Arming .....	1-30
Continuous Time Interval Measurement with Event Holdoff Arming .....	1-31
Continuous Time Interval Measurement with Interval Sampling Arming .....	1-32
Continuous Time Interval Measurement with Repetitive Edge Arming .....	1-33
Continuous Time Interval Measurement with Edge/Interval Arming .....	1-34

± Time Interval Measurements .....	1-36
± Time Interval Measurement with Automatic Arming .....	1-36
± Time Interval Measurement with Edge Holdoff Arming .....	1-37
± Time Interval Measurement with Interval Sampling Arming ..	1-38
± Time Interval Measurement with Parity Sampling Arming ....	1-39
± Time Interval Measurement with Repetitive Edge Arming ....	1-41
± Time Interval Measurement with Repetitive Edge-parity Arming .....	1-42
± Time Interval Measurement with Random Sampling Arming .	1-44
± Time Interval Measurement with Edge/Interval Arming .....	1-45
± Time Interval Measurement with Edge/Event Arming .....	1-47
± Time Interval Measurement with Edge/Parity Arming .....	1-49
± Time Interval Measurement with Time/Time Arming .....	1-51
± Time Interval Measurement with Event/Event Arming .....	1-53
± Time Interval Measurement with Edge/Random Arming .....	1-55

# TIME INTERVAL MEASUREMENTS

---

## CHAPTER OVERVIEW

This chapter describes the time interval measurements of the HP 5372A and how to use them.

The HP 5372A makes three types of time interval measurements:

- Time Interval (TI)
- Continuous Time Interval (CTI)
- $\pm$ Time Interval ( $\pm$ TI)

The topics discussed in this chapter are:

- A comparison of Time Interval, Continuous Time Interval, and  $\pm$ Time Interval measurements
- Examples of how to interpret time interval results
- An illustration of each time interval measurement and arming mode

## TECHNICAL COMMENT

---

*Several basic concepts of the HP 5372A are described at the beginning of Chapter 2.*

*Please review the following topics in Chapter 2 for the fundamentals of how the HP 5372A makes measurements:*

- *Time and Events*
  - *A sample*
  - *Sampling*
- 

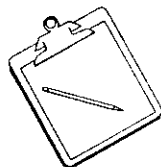

## TIME INTERVAL MEASUREMENTS COMPARED

A time interval is a measurement of elapsed time between two electrical pulses. Electrical pulses are defined by changes in voltage. Rising voltage is associated with a positive-going edge or slope and falling voltage with a negative-going edge. These changes in voltage can trigger the start and stop of a measurement. A “trigger event” is a specific voltage on a rising or falling slope of an input signal that will trigger the HP 5372A. For example, the trigger event can be specified on the Input menu of the HP 5372A as a 500 mV level on the positive slope of a signal. *Figure 1-1* shows such a setting on the Input menu.

Figure 1-1.  
Trigger Event  
Settings

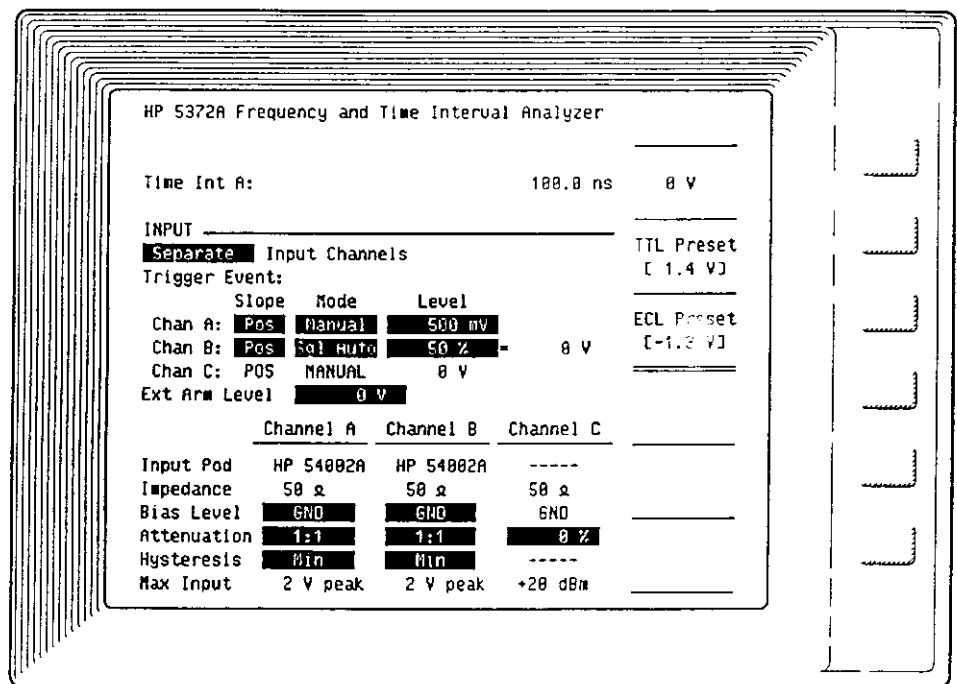

## Normal/Fast Measurement Mode

The rate at which the HP 5372A is able to store measurement data can be set to one of two settings. The feature is called “Measurement Mode,” and is set on the System Menu. The choices are Normal and Fast. Be aware that the range of measurement is limited with some arming modes when using the Fast Measurement Mode. The exact range of operation is included with the arming mode descriptions that follow.

- Normal Measurement Mode:

TI and  $\pm$ TI — 200 ns between measurements is required to store data

CTI — 100 ns between measurement samples is required to store data

- Fast Measurement Mode:

TI and  $\pm$ TI — 135 ns between measurements is required to store data

CTI — 75 ns between measurement samples is required to store data

## Time Interval

The Time Interval function measures time intervals on one input channel, or positive time intervals from one channel to another. The measurements are "individual." That is, there is a start and stop for each measurement. After each measurement, the data for that measurement is stored away. Only then can another measurement start.

The Time Interval function measures time intervals from 10 ns to 8.0 seconds (10 ns to 131  $\mu$ s in Fast Mode). Data storage between measurements takes 200 ns in the Normal measurement mode and less than 135 ns in the Fast measurement mode. (For more on Normal and Fast measurement modes, refer to "System Menu," chapter 12.) If you need to measure time intervals less than 10 ns, use  $\pm$  TI. The two examples below show how TI measurements are made.

Figure 1-2 shows an example of a one-channel Time Interval measurement—

Figure 1-2.  
Time Interval on  
One Channel

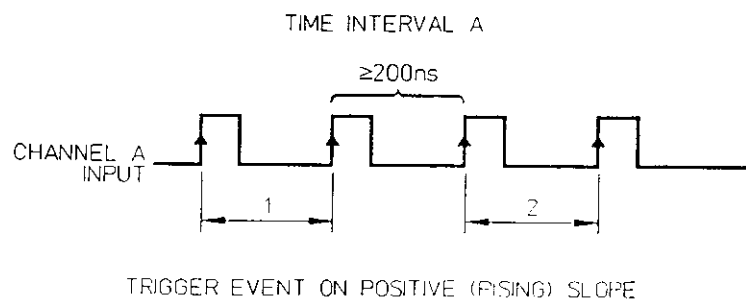

WF01.N04

Note that the HP 5372A can display when each measurement occurs, by the number of trigger events or time, with the Time Variation graph on the Graphic screen. For more information on Time Variation graph, refer to "Graphic Results," chapter 16.

Figure 1-3 shows an example of a two-channel Time Interval measurement—

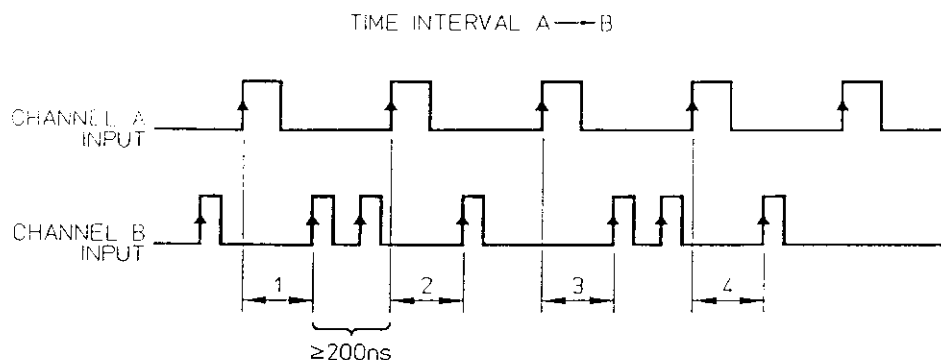

NOTE THAT MEASUREMENTS ALWAYS START ON THE CHANNEL A SIGNAL

WF02\_N04

Figure 1-3. Time Interval on Two Channels

A pulse-width measurement is also a “two-channel” measurement, although it is made on a single input signal. Pulse-width measurements are described in “Special-Purpose Measurements,” chapter 3.

### Continuous Time Interval

The Continuous Time Interval function measures single-channel time intervals only. This time interval type is called continuous because, unlike the other time interval types, CTI provides time interval results between every pair of samples, rather than only between start and stop pairs. Compare the CTI measurement in Figure 1-4 with the TI measurement in Figure 1-2.

The Continuous Time Interval function measures time intervals from 100 ns to 8.0 seconds in the Normal measurement mode and 75 ns to 131  $\mu$ s in the Fast measurement mode. (For more on Normal and Fast measurement modes, refer to “System menu,” chapter 12.)

Figure 1-4 shows an example of a Continuous Time Interval measurement—

Figure 1-4.  
Continuous Time  
Interval

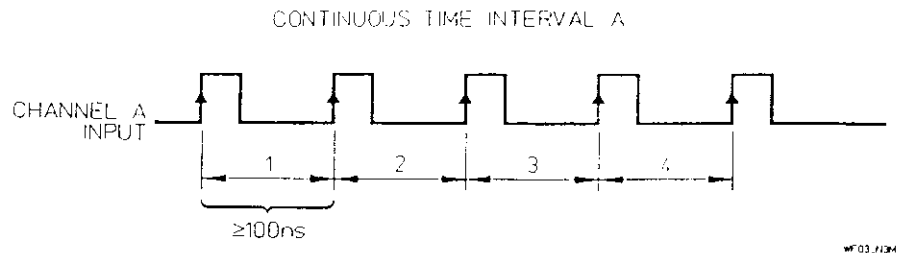

Continuous Time Interval is similar to a Period measurement, but CTI never provides the average time interval when a measurement occurs over more than one period of the signal. A CTI result is the time over which the measurement was made. A Period result is the average of the signal periods that occur during the time of the measurement. Figure 1-5 compares CTI and Period measurements.

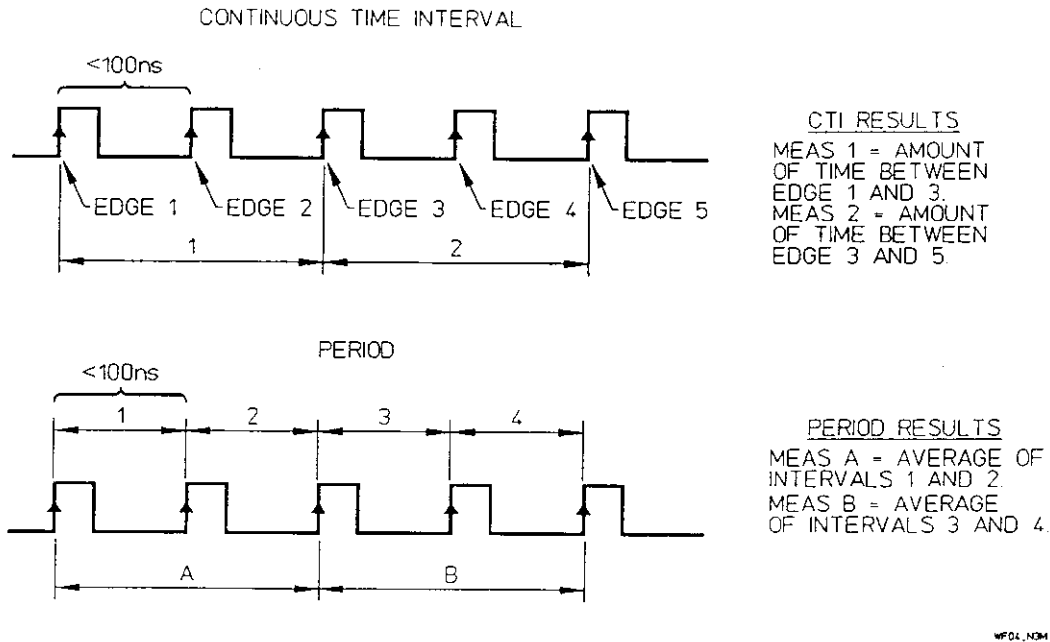

Figure 1-5. Continuous TI vs. Period

**±Time Interval**

The ±Time Interval function measures positive or negative time intervals on one channel, or from one channel to another channel. The measurements are "individual." As with TI measurements, there is a start and stop for each measurement. After each measurement, the data for that measurement is stored away. Only then can another measurement start.

The  $\pm$  TI function measures intervals from  $-4.0$  seconds to  $+4.0$  seconds, including  $0$  seconds ( $-65 \mu\text{s}$  to  $+65 \mu\text{s}$  in Fast Mode). Data storage between measurements takes  $200 \text{ ns}$  in the Normal measurement mode and  $135 \text{ ns}$  in the Fast measurement mode. (For more on Normal and Fast measurement modes, refer to "System Menu," chapter 12.) You can measure intervals less than  $10 \text{ ns}$  with  $\pm$ TI ( $0$  seconds with two-channel  $\pm$ TI). The two examples below show how  $\pm$ TI measurements are made.

Figure 1-6 shows an example of a one-channel  $\pm$ Time Interval measurement—

Figure 1-6.  
 $\pm$ Time Interval on  
One Channel

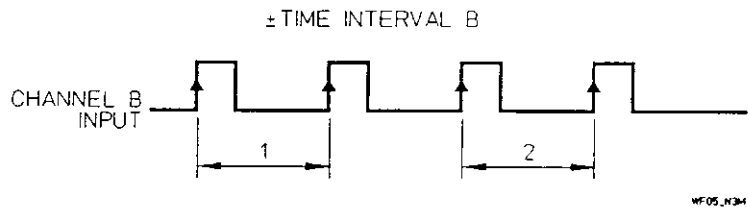

The only difference between a TI measurement on one channel and a  $\pm$ TI on one channel is that the  $\pm$ TI can measure shorter time intervals.

Figure 1-7 shows an example of a two-channel  $\pm$ Time Interval measurement—

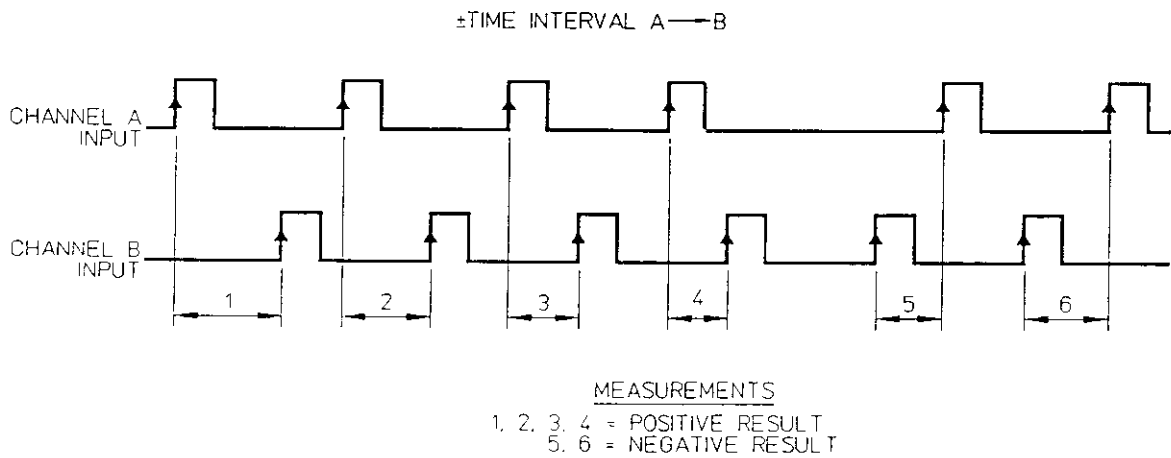

Figure 1-7.  $\pm$ Time Interval on Two Channels



## HOW TO INTERPRET TIME INTERVAL RESULTS



This section describes two time interval measurements and how to interpret the measurement results. For each example, the signal to be measured is described, and the arming mode used for the measurement is explained.

### TECHNICAL COMMENT

*Arming is an important element of every HP 5372A measurement setup. It allows you to specify when to begin a group of measurements and how often measurement samples within the group will be acquired.*

*Refer to "Arming," chapter 5, for more on what arming is and how it works. In the following examples of time interval measurements, different arming modes are demonstrated to show their effect on the measurements.*

### Time Interval with Missed Events Example

This example describes a Time Interval measurement where not all intervals are measured because of the rate at which events are occurring. The description here also applies to  $\pm$ TI measurements. The signal to be measured is shown in Figure 1-8.

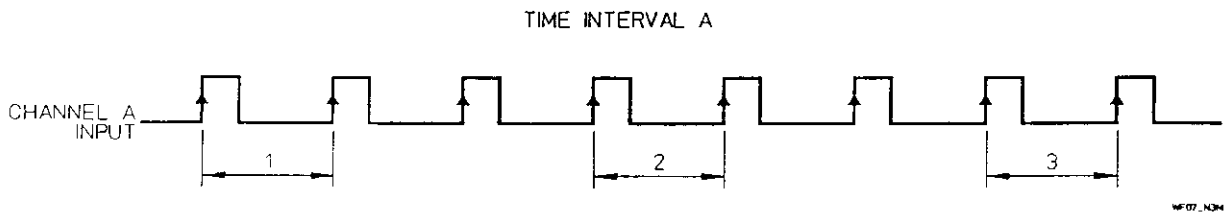
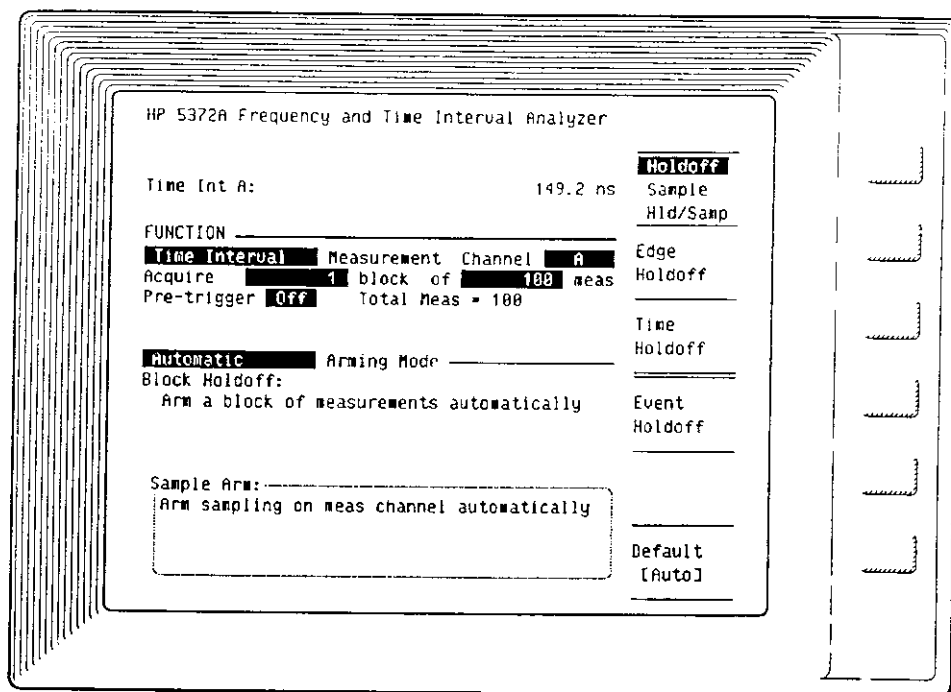

Figure 1-8. Time Interval on Channel A

Because the time intervals are occurring at a rate at which the HP 5372A is not able to capture every interval, there are time intervals that are not measured. Even though the intervals are not measured, the number of edges of the input signal between each measurement is known, as well as the time between each measurement. The results from this example will show how this works.

1. The Function menu is the default setup selected with the Preset key. The menu is shown in Figure 1-9.

Figure 1-9.  
Function Menu



The arming mode is Automatic. Automatic arming begins the group of measurements as soon as possible and provides for acquisition of measurement samples as quickly as possible.

2. The Numeric screen in *Figure 1-10* shows a portion of the results. The Expanded Data feature is set to On.

Figure 1-10.  
Time Interval results

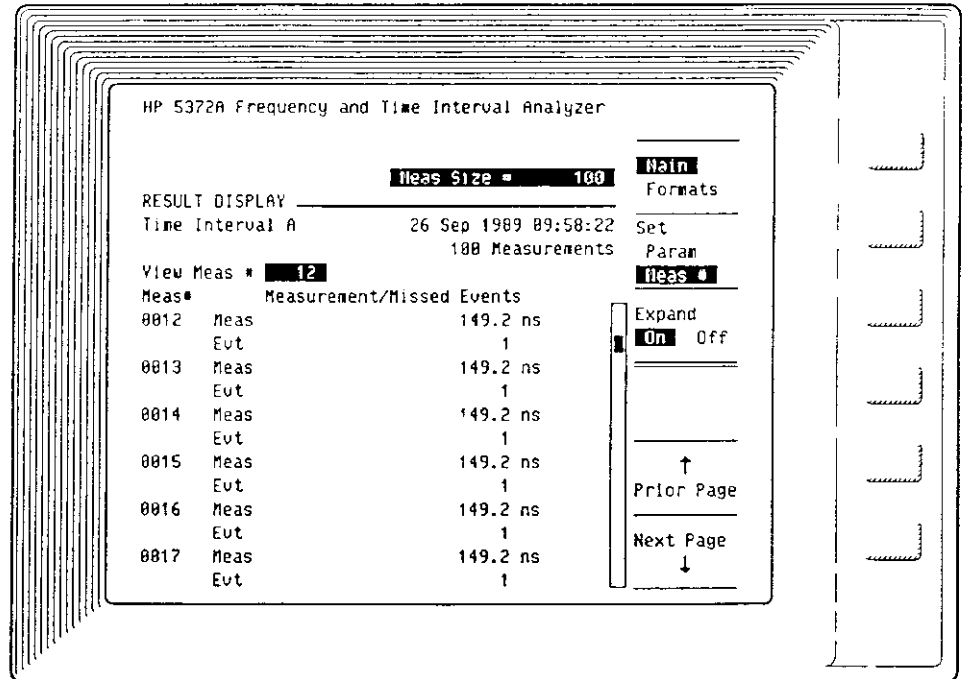

The Expanded Data feature displays the number of events that are "missed" during time interval measurements. According to the results, one event is missed between each measurement. A missed event is an edge of the input signal that is counted, but not timed. Since when the event occurred is not known, no measurement can be computed. Because the HP 5372A continues to count time and events during a group of measurements, it can provide the time between measurements, as well as the time of measurements. This can be seen on the Event Timing graph in *Figure 1-11*. The time from the end of one measurement to the beginning of the next is displayed with the Delta feature.

Figure 1-11.  
Time Between  
Measurements

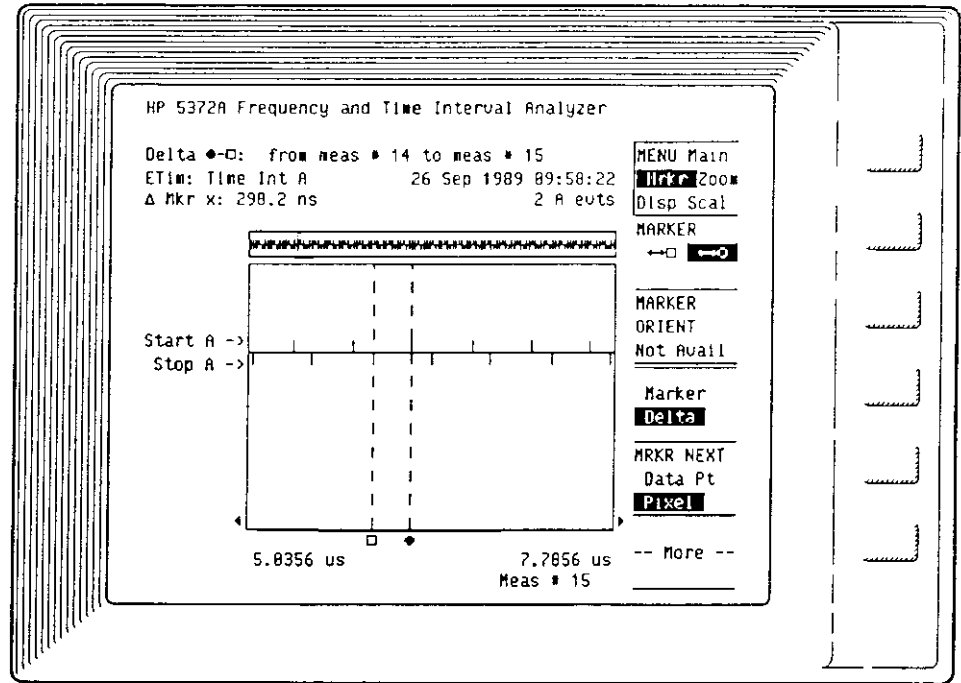

This information is presented with the waveform of the signal in Figure 1-12.

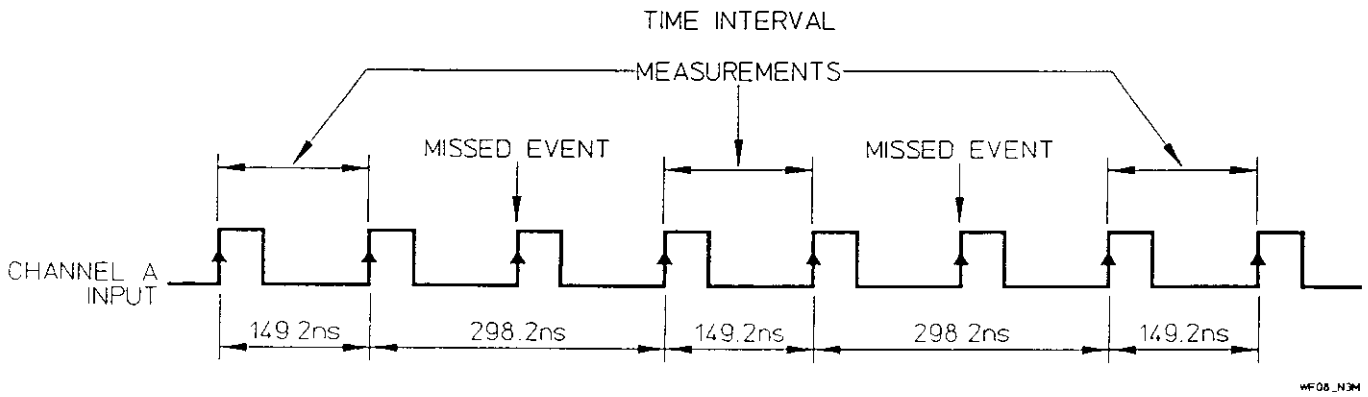
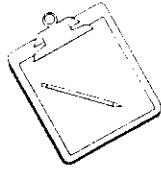
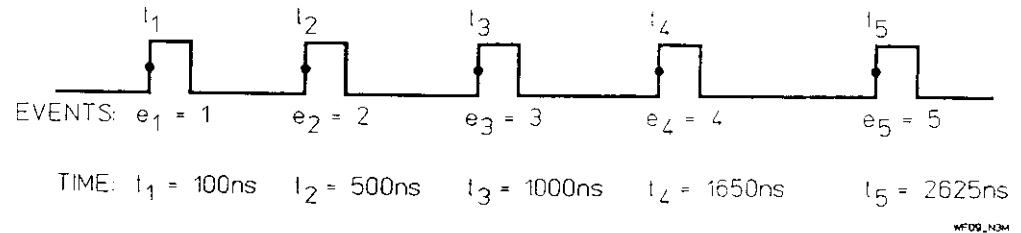

Figure 1-12. Time Interval With Missed Events



### TECHNICAL COMMENT

When the HP 5372A collects measurement data, it is in the form of a count of events and time. The event count is the number of trigger events (an event as specified on the Input menu) that have occurred since the start of the measurement sequence. The time is the elapsed time from the beginning of the measurement sequence to when the event occurs. You can see in the drawing below a graphic representation of this idea of keeping a running total of the number of events and the time they occurred.



From this event and time data, the results for the measurement functions can be computed. When events are occurring faster than the HP 5372A can store the time of the events, the number of events without the time of occurrence information is known and can be displayed as missed events on the Numeric screen using the Expanded Data feature.

### Continuous Time Interval with Missed Events Example

This example will show what missed events means for CTI as opposed to missed events for TI and  $\pm$ TI. Again, this situation occurs when events are occurring at rate faster than the HP 5372A is able to store away the time at which the event occurred. You should compare this example with the previous TI measurement example. The comparison highlights the differences between the individual measurement technique of TI and  $\pm$ TI and the continuous nature of CTI measurements.

This CTI measurement is made with Event Holdoff arming. Holdoff arming lets you control when the block of measurements can begin. In this example, the first measurement will not begin until after the specified number of events have occurred following a signal on the External Arm input. The samples of measurement data will then be collected as quickly as possible. If another block of measurements was collected, the Holdoff condition would need to be satisfied once again before the measurements could begin.

1. The Function menu setup for this measurement is shown in *Figure 1-13*.

*Figure 1-13.*  
Function Menu

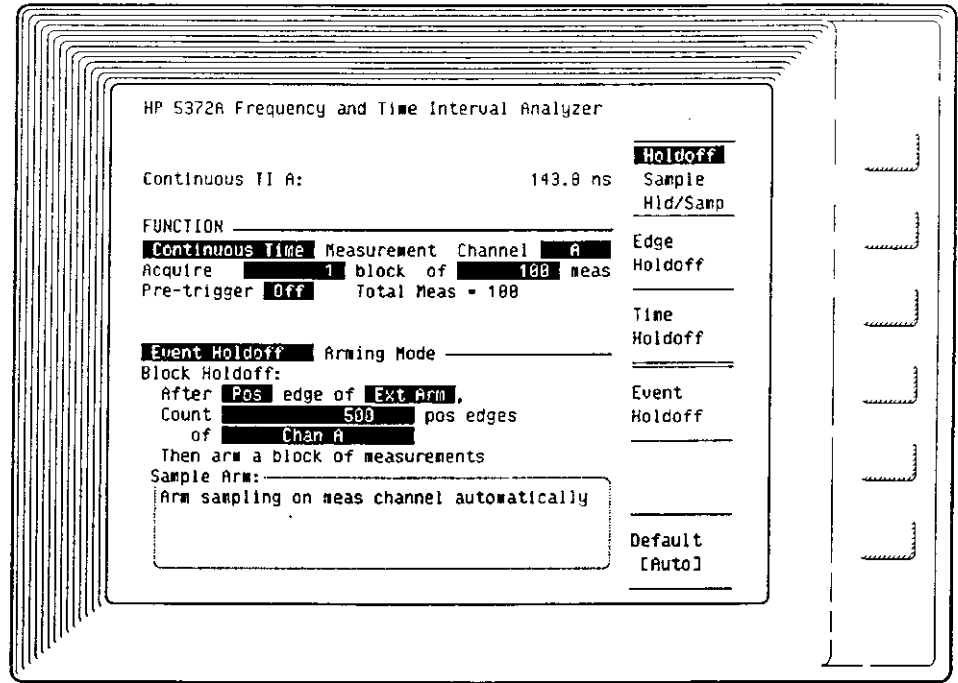

As described on the menu, after a positive event on External Arm, 500 events will be counted on Channel A before the first measurement sequence begins.

2. The Numeric screen in *Figure 1-14* shows a portion of the results. The Expanded Data feature is set to On.

Figure 1-14.  
Continuous Time  
Interval Results

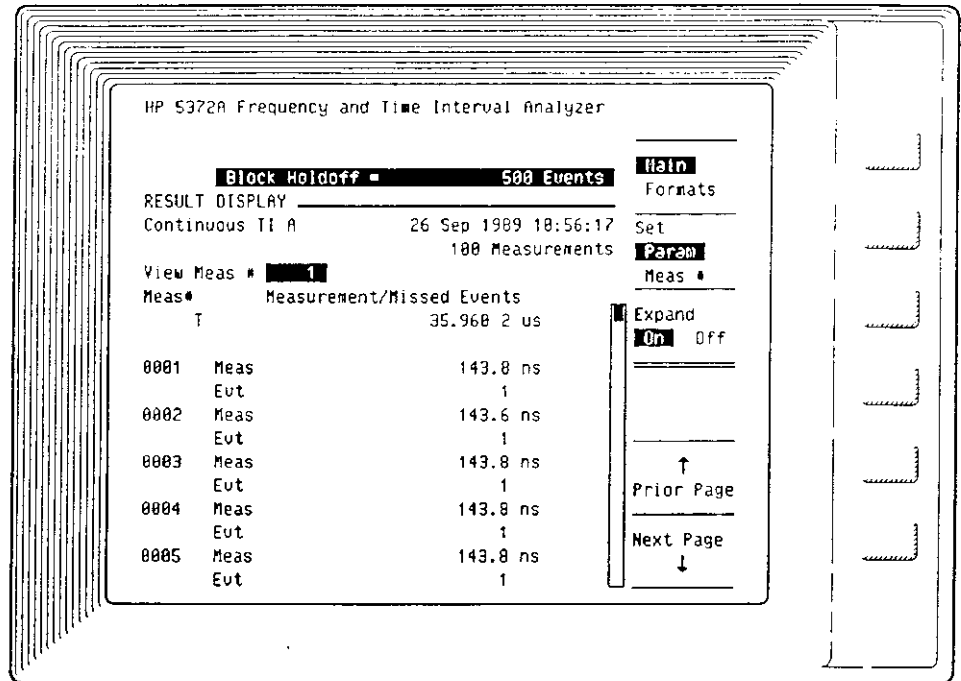

The Numeric screen shows that one event was missed for each measurement. For CTI measurements, this means that one event was not timed during each measurement, but was included in the measurement. Notice the time listed before the first measurement. It is preceded by a "T". This is the time from the occurrence of the event on External Arm to when the first measurement sample is acquired. For this example, "T" is the time for 500 events.

#### TECHNICAL COMMENT

The "T" time displayed on the Numeric screen in this example is called, the Time Stamp of the block arming edge. It is provided for this measurement setup of CTI with Event Holdoff. This feature of referencing the arming edge provides the ability to reference a group of measurements (a block) to the arming edge of the block. Multiple blocks of measurements can then be averaged by the HP 5372A. There is a Function menu field that will appear when the number of blocks is set to more than 1 for configurations that allow averaging. Averaged results will be displayed on the Numeric screen and the Time Variation graph on the Graphic screen. The arming modes for CTI that provide for averaging are noted in this chapter. This feature is also described in "Arming," chapter 5 and in "Function Menu," chapter 7.

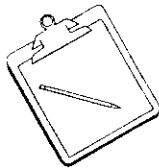

The one event that is missed during each measurement is included in the measurement result. This is shown in the waveform in *Figure 1-15* that represents a portion of the measured signal.

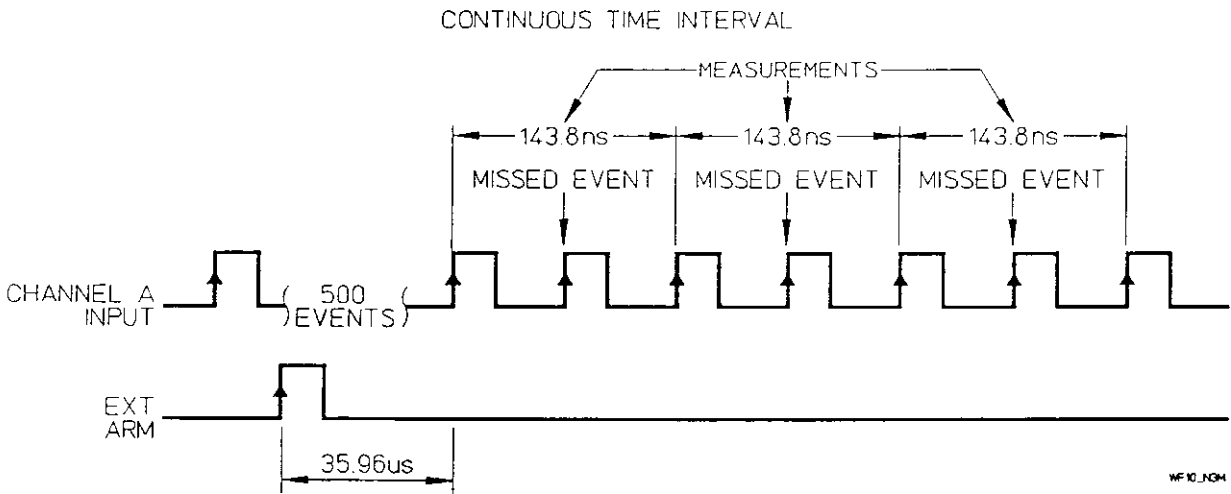
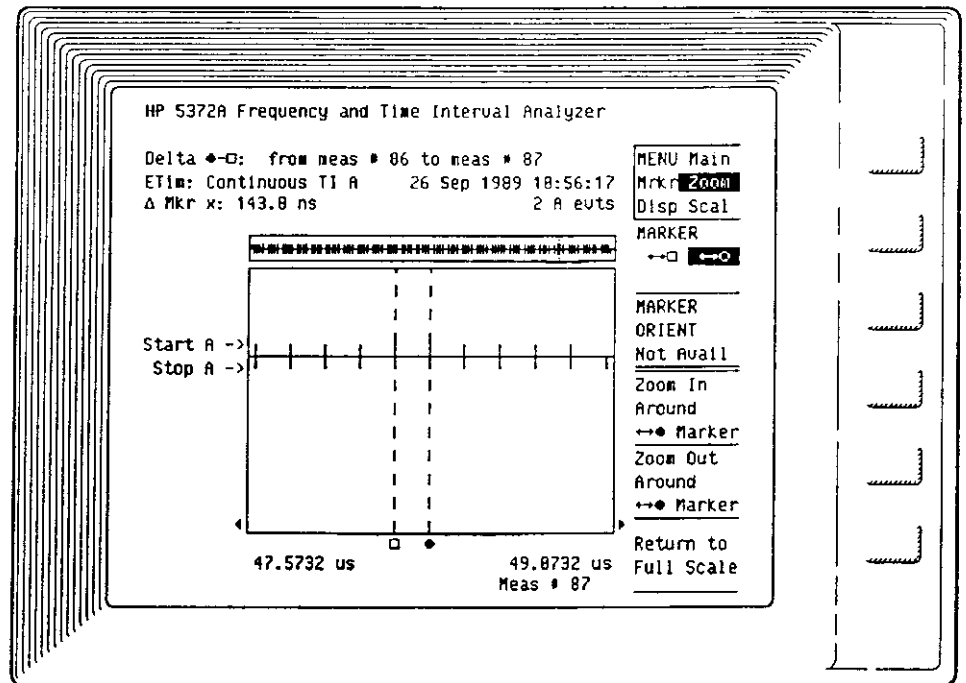

Figure 1-15. CTI With Missed Events



Two periods of the input signal are collected for each measurement. This information is also represented by the Event Timing graph on the Graphic screen. Notice that the start and stop ticks on the graph line up. This shows that the end of one measurement is also the start of the next. See Figure 1-16 below.

Figure 1-16.  
Event Timing Graph  
of CTI



# TIME INTERVAL ARMING MODES

Shown below are the measurement channels and arming modes available for each of the time interval types.

## HP 5372A Function and Arming Summary

ARMING MODE	MEASUREMENT FUNCTION																	
	TIME INTERVAL OR HISTOGRAM TI		CONTINUOUS TIME INTERVAL OR HISTOGRAM CTI	± TIME INTERVAL OR HISTOGRAM ± TI		FREQUENCY, PERIOD		TOTALIZE		POS WIDTH	NEG WIDTH	RISE TIME	FALL TIME	DUTY CYCLE	PHASE	PEAK AMPLITUDE	PHASE DEVIATION	TIME DEVIATION
	A	A → B	A	A	A → B	A	DUAL <sup>1</sup>	A	DUAL <sup>1</sup>	A				A	A rel B	A	A	A
	B	B → A	B	B	B → A	B	RATIO <sup>2</sup>	B	RATIO <sup>2</sup>					B rel A	B	B	B	B
						C	SUM <sup>3</sup>		SUM <sup>3</sup>									
							DIFF <sup>4</sup>		DIFF <sup>4</sup>									
AUTOMATIC																		
AUTOMATIC	C*	C*	C*		C*	G*	G*							C*	C*	N*	C*	C*
HOLDOFF																		
EDGE HOLDOFF	C	C	C		C	C								C			C	C
TIME HOLDOFF	C	C	C			C												
EVENT HOLDOFF	C	C	C			C												
SAMPLING																		
INTERVAL SAMPLING	C	C	C		C	C	C	C*	C*					C			C	C
TIME SAMPLING						N												
CYCLE SAMPLING						C												
EDGE SAMPLING						C	C	C	C									
PARITY SAMPLING					C													
REPET EDGE SAMPLING	C	C	C		C													
REPET EDGE-PARITY SAMPLING					C													
RANDOM SAMPLING	C	C			C													
HOLDOFF/SAMPLING																		
EDGE/INTERVAL	C	C	C		C	C	C	C	C					C			C	C
EDGE/TIME						N												
EDGE/EDGE						C		C	C									
EDGE/CYCLE						C												
EDGE/EVENT					N	N	N											
EDGE/PARITY					C													
EDGE/RANDOM	C	C			C													
TIME/INTERVAL						C		C										
TIME/TIME					N	N	N											
EVENT/INTERVAL						C												
EVENT/EVENT					N*	N	N											
EXTERNALLY GATED						C		C	C									
MANUAL								N	N									

Symbol C or N indicates that a measurement can be made using the corresponding combination of Function, Channel, and Arming selections.

C = Continuous Arming, (Block/Sample Arming)

N = Non-Continuous arming, (Start/Stop Arming), setups are limited to M blocks of 1 measurement.

1. DUAL. Simultaneous Dual-channel, (2 results). Frequency and Period options are: A&B, A&C, B&C. Totalize option is: A&B.

2. RATIO. Frequency and Period ratio options are: A/B, A/C, B/A, B/C, C/A, C/B. Totalize ratio options are: A/B, B/A.

3. SUM. Frequency and Period sum options are: A+B, A+C, B+C. Totalize sum option is: A+B.

4. DIFFERENCE. Frequency and Period difference options are: A-B, A-C, B-A, B-C, C-A, C-B. Totalize difference options are: A-B, B-A.

\* = Default Arming

## Measurements Referenced To The Block Arming Edge

There are four arming modes for Continuous Time Interval measurements that reference all measurements of a block to the block holdoff arming edge. They are:

- Edge Holdoff
- Time Holdoff
- Event Holdoff
- Edge / Interval

For these arming modes, the edge which arms each block is "time-stamped," and the elapsed time between the block arming edge and the first measurement sample is measured.

While all the arming modes provide the time from the beginning of the first measurement of a block, these time-stamp arming modes also provide the time between the block arming edge and the first measurement sample that is collected. The time value is displayed on the Numeric screen. It is listed before the first measurement result of the block and has a "T" in front of it. The diagrams in the next part of this chapter show the time-stamp arming modes with a portion of the example signal labeled with a "T".

---

### NOTE

*To receive valid data, the interval between the block arming edge and the first measurement sample must be within the measurable range of the selected measurement mode:*

*Normal Measurement Mode = 10 ns to 8.0 s*

*Fast Measurement Mode = 10 ns to 131 us*

---

**TECHNICAL COMMENT**

---

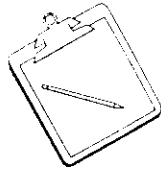

*The HP 5372A has been optimized to always capture both the block arming edge and the first measurement sample, even if they occur only 10 ns apart.*

*If the first measurement sample is received by the HP 5372A less than 100 ns (75 ns for Fast mode) after the block arming edge, the measurement sample will be captured, but the instrument will be storing data during the 180 ns which follow the arming edge. During that 180 ns, trigger events of the measurement signal will be counted but will have no time data associated with them.*

---

**Averaged Results  
for Continuous  
Time Interval**

The feature of time-stamping the arming edge makes it possible for the HP 5372A to average multiple blocks of measurements. When you select one of the four arming modes from the previous page for a multiple-block Continuous Time Interval measurement, a field on the Function menu will allow selection of "Averaged Results" (the other option is "All Results"). The averaged results are shown on the Numeric screen, the Time Variation and Event Timing graphs. If the total number of measurements selected exceeds the size of internal memory, "Averaged Results" is the only option available.

**TIME INTERVAL  
ARMING MODE  
EXAMPLES**

This section shows the different types of time interval measurements along with a timing diagram to illustrate each available arming mode. In all the examples, the rate of events to be measured is assumed to be within the HP 5372A's capability to collect event and time data for all measurement trigger events. The trigger event is the positive slope of the measurement signal for these examples.

**Time Interval  
Measurements****TIME INTERVAL MEASUREMENT  
WITH AUTOMATIC ARMING**

Figure 1-17. Time Interval | Automatic

**DESCRIPTION:**

- A block of measurements can begin as soon as the Analyzer is ready.
- Measurement data is collected as quickly as possible at the trigger events of the signals being measured. Four measurements are shown.

### TIME INTERVAL MEASUREMENT WITH EDGE HOLDOFF ARMING

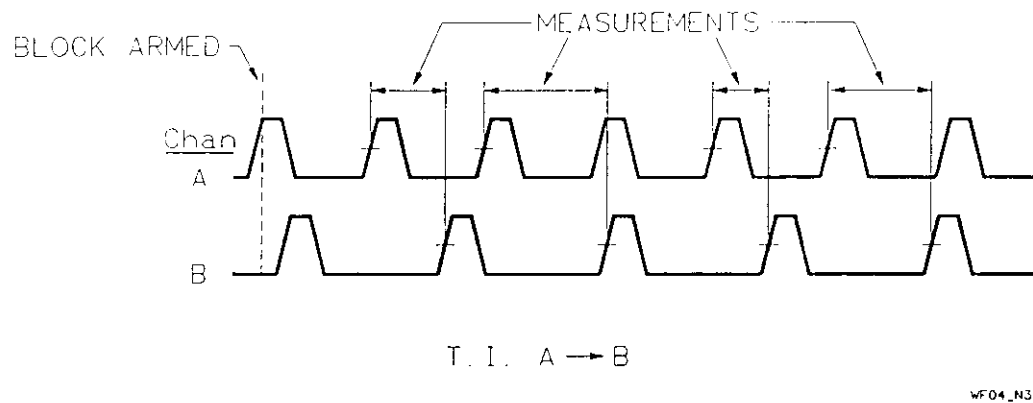
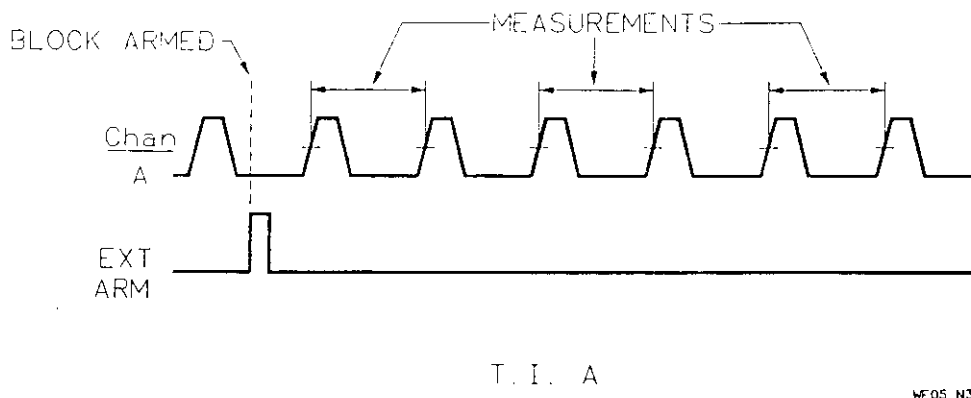

Figure 1-18. Time Interval | Edge Holdoff

#### DESCRIPTION OF DIAGRAM:

- A block of measurements can begin after a positive edge on External Arm. The measurement start is delayed until the arming edge occurs.
- Measurement data is then collected as quickly as possible at the trigger events of Channel A. Three measurements are shown.
- The diagram shows an edge holdoff of a positive edge on External Arm. Other options are a positive or negative edge on Channel A or B.

## TIME INTERVAL MEASUREMENT WITH TIME HOLDOFF ARMING

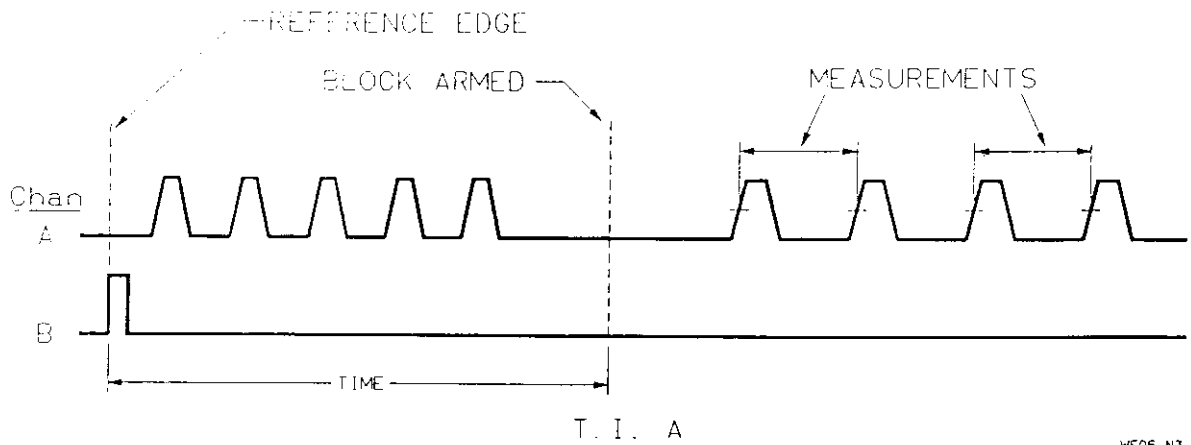
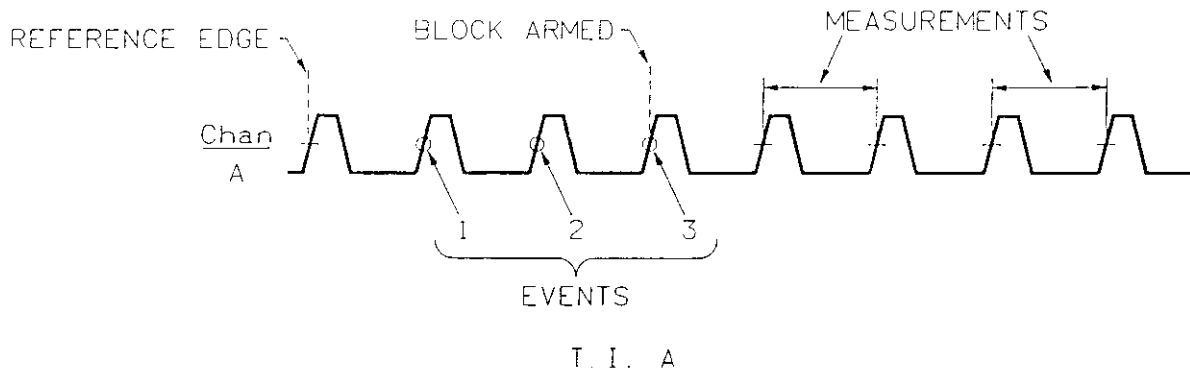

Figure 1-19. Time Interval | Time Holdoff

### DESCRIPTION OF DIAGRAM:

- A block of measurements can begin after a selectable time delay. The start of the delay is referenced to a positive edge on Channel B.
- Measurement data is then collected as quickly as possible at the trigger events of Channel A. Two measurements are shown.
- The diagram shows the time delay referenced to a positive edge on Channel B. Other options are a positive or negative edge on Channel A or External Arm.
- For Normal Measurement Mode —  
Range of Time = 2 ns to 8.0 s. Can be set with a 2 ns resolution.
- For Fast Measurement Mode —  
Range of Time = 2 ns to 131  $\mu$ s. Can be set with a 2 ns resolution.

### TIME INTERVAL MEASUREMENT WITH EVENT HOLDOFF ARMING



WF07\_N3

Figure 1-20. Time Interval | Event Holdoff

#### DESCRIPTION OF DIAGRAM:

- A block of measurements can begin after a selectable event delay. The start of the three-event delay here is referenced to a positive edge on Channel A.
- Measurement data is then collected as quickly as possible at the trigger events of Channel A. Two measurements are shown.
- The diagram shows an event delay referenced to a positive edge on Channel A. Other options are a positive or negative edge on Channel B or External Arm.
- The delay events can be on Channel A or B.
- For Normal Measurement Mode:  
Range of Events = 0 to 4,000,000,000
- For Fast Measurement Mode:  
Range of Events = 0 to 65,000



## TIME INTERVAL MEASUREMENT WITH INTERVAL SAMPLING ARMING

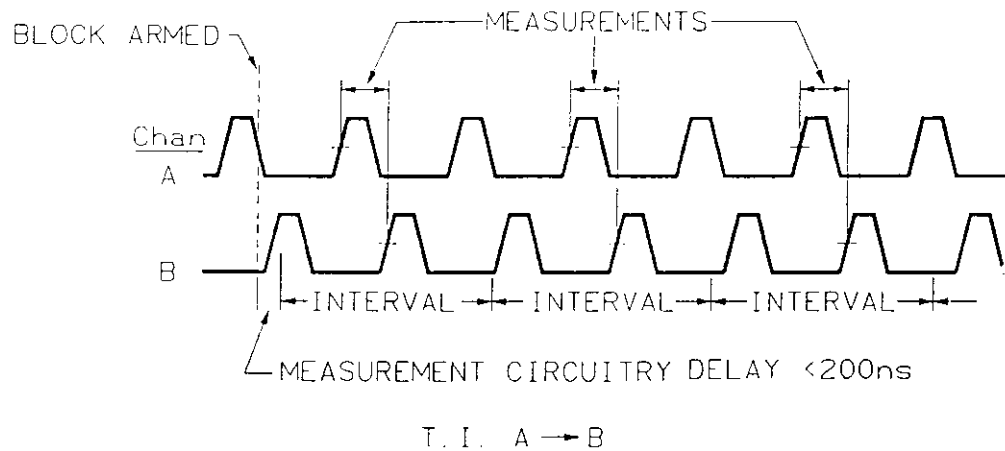

WF08\_N3

Figure 1-21. Time Interval | Interval Sampling

### DESCRIPTION OF DIAGRAM:

- A block of measurements can begin as soon as the Analyzer is ready.
- For Time Interval measurements, one measurement is taken per interval when the specified sample interval is longer than the time interval measured. If the sample interval is shorter than the time interval measured, the measurement data will be collected just as it is for Time Interval measurements using the Automatic arming mode. In the example shown above, the sample interval sets the time between measurements. The sample interval is repetitive and asynchronous with the signal being measured. Three measurements are shown.
- For Normal Measurement Mode:
 

Range of Interval = 100 ns to 8.0 s. Can be set with a resolution of 100 ns.
- For Fast Measurement Mode:
 

Range of Interval = 100 ns to 131  $\mu$ s. Can be set with a resolution of 100 ns.

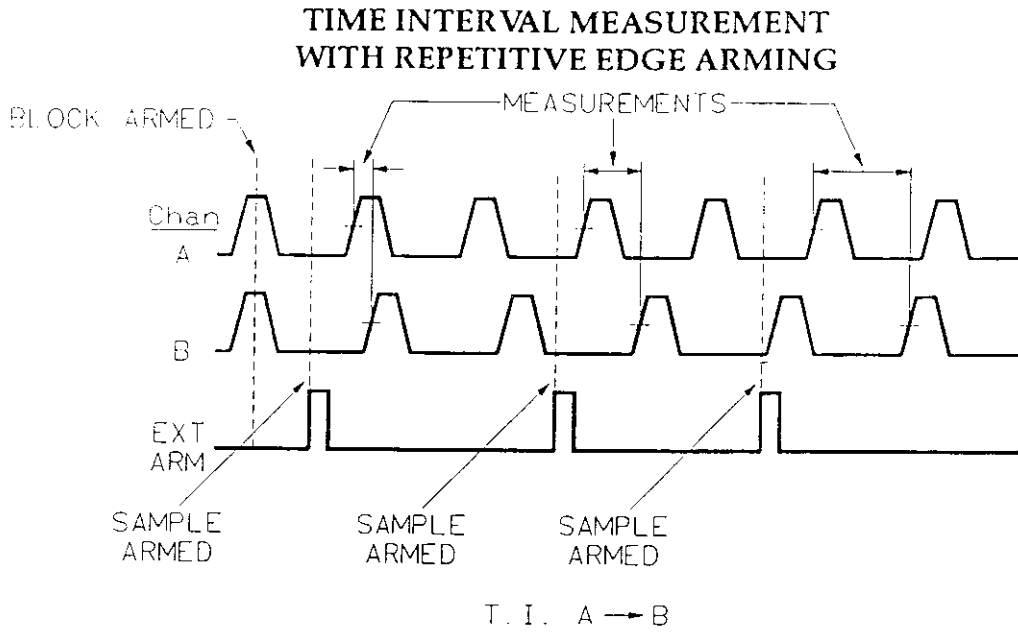

Figure 1-22. Time Interval | Repetitive Edge

**DESCRIPTION OF DIAGRAM:**

- A block of measurements can begin as soon as the Analyzer is ready.
- Measurement data for one measurement is then collected after each positive edge on External Arm. There is one measurement per arming edge. Three measurements are shown.
- The diagram shows a sample arm of a positive edge on External Arm. Other options are a positive or negative edge on Channel A or B.

### TIME INTERVAL MEASUREMENT WITH RANDOM SAMPLING ARMING

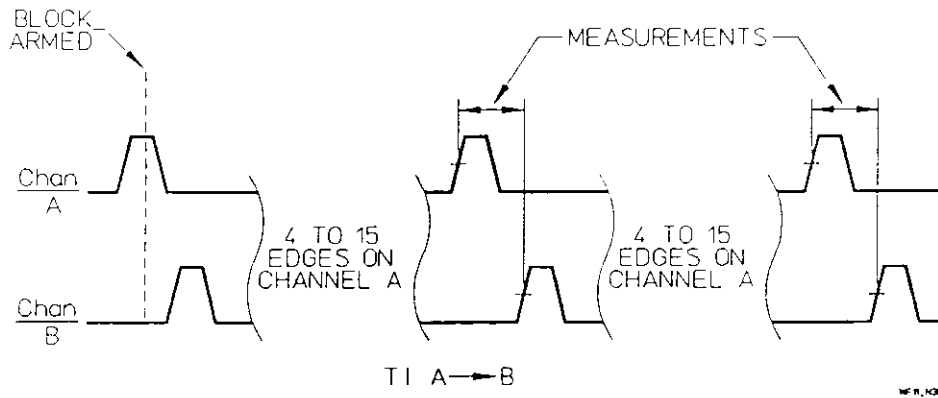

Figure 1-23. Time Interval | Random Sampling

#### DESCRIPTION OF DIAGRAM:

- A block of measurements can begin as soon as the Analyzer is ready.
- Measurement data for each measurement is then collected after a random number of edges on Channel A. The random number of edges on Channel A varies from 4 to 15 between each measurement.
- HP 5372A always randomizes on Channel A.
- Random sampling is only valid up to a 100 MHz rate. For more information, refer to "Arming," chapter 5.

#### NOTE

*The pseudo-random sequence generator operates in a "free-run" mode. Because of this, the first measurement in a sequence can occur after fewer than four edges on Channel A. For the measurements that follow, the pseudo-random sequence generator arms a measurement every six to seventeen edges on Channel A.*

### TIME INTERVAL MEASUREMENT WITH EDGE/INTERVAL ARMING

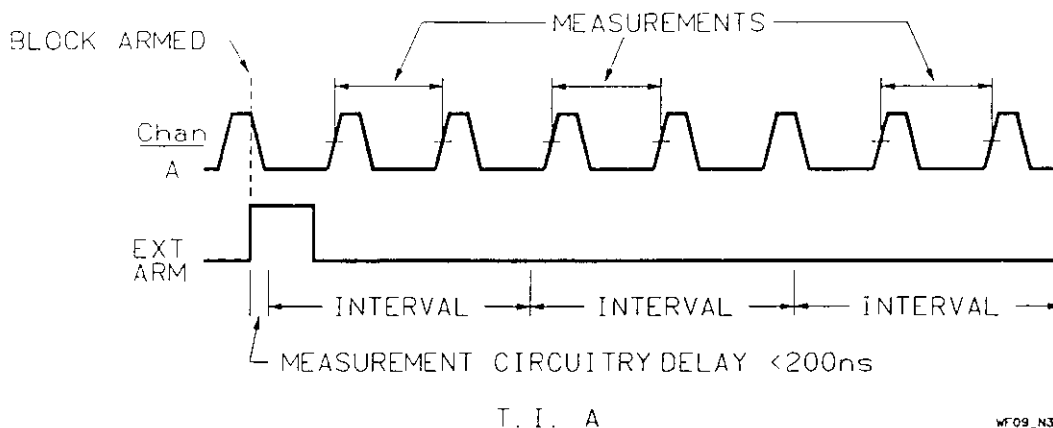

Figure 1-24. Time Interval | Edge/Interval

#### DESCRIPTION OF DIAGRAM:

- A block of measurements can begin after a positive edge on External Arm. The start is delayed until the arming edge occurs.
- For Time Interval measurements, one measurement is taken per interval when the specified sample interval is longer than the time interval measured. If the sample interval is shorter than the time interval measured, the measurement data will be collected just as it is for Time Interval measurements using the Automatic arming mode. In the example shown above, the sample interval sets the time between measurements. The sample interval is repetitive and asynchronous with the signal being measured. Three measurements are shown.
- The diagram shows an edge holdoff of a positive edge on External Arm. Other options are a positive or negative edge on Channel A or B.
- For Normal Measurement Mode:
 

Range of Interval = 100 ns to 8.0 s. Can be set with a resolution of 100 ns.
- For Fast Measurement Mode:
 

Range of Interval = 100 ns to 131  $\mu$ s. Can be set with a resolution of 100 ns.

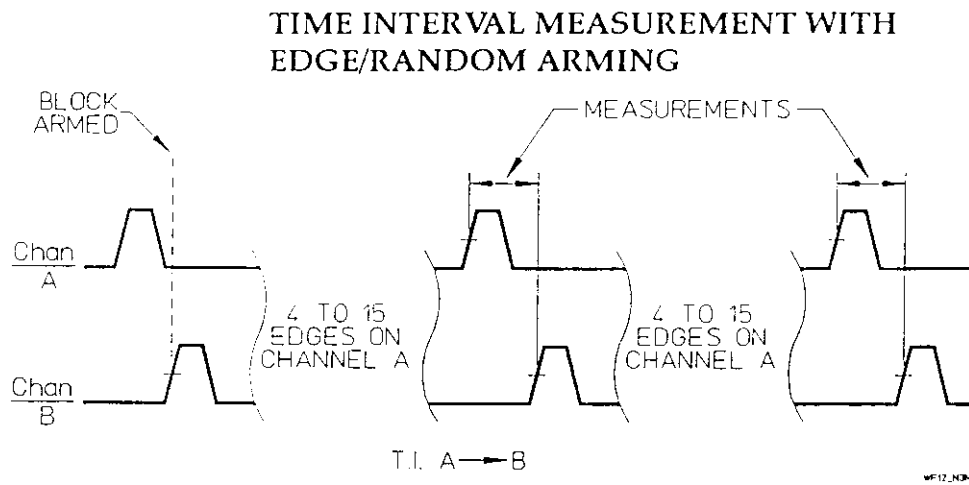

Figure 1-25. Time Interval | Edge/Random

#### DESCRIPTION OF DIAGRAM:

- A block of measurements can begin after a positive edge on Channel B. The measurement start is delayed until the arming edge occurs.
- Measurement data is then collected for each measurement after a random number of edges on Channel A. The random number of edges on Channel A varies from 4 to 15 between each measurement.
- The diagram shows an edge holdoff of a positive edge on Channel B. Other options are a positive or negative edge on Channel A or External Arm.
- HP 5372A always randomizes on Channel A.
- Random sampling is only valid up to a 100 MHz rate. For more information, refer to "Arming," chapter 5.

#### NOTE

*The pseudo-random sequence generator operates in a "free-run" mode. Because of this, the first measurement in a sequence can occur after fewer than four edges on Channel A. For the measurements that follow, the pseudo-random sequence generator arms a measurement every six to seventeen edges on Channel A.*

### Continuous Time Interval Measurements

### CONTINUOUS TIME INTERVAL MEASUREMENT WITH AUTOMATIC ARMING

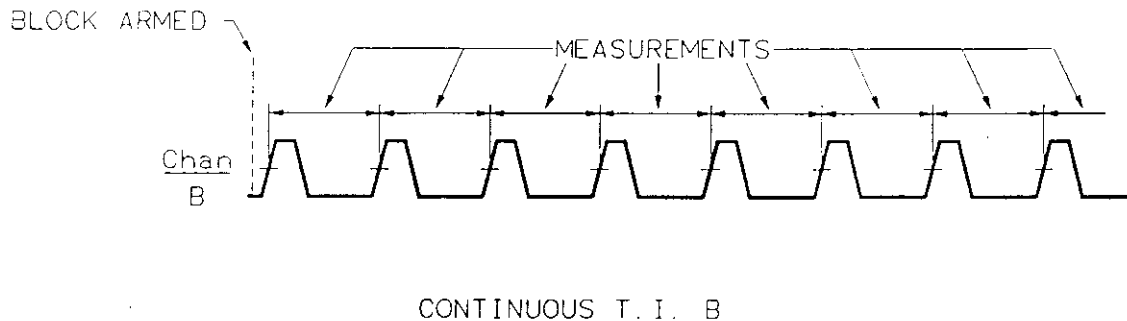

WF11\_N3

Figure 1-26. Continuous Time Interval | Automatic

#### DESCRIPTION OF DIAGRAM:

- A block of measurements can begin as soon as the Analyzer is ready.
- Measurement data is then collected as quickly as possible at the trigger events of Channel B. Seven measurements are shown.

### CONTINUOUS TIME INTERVAL MEASUREMENT WITH EDGE HOLDOFF ARMING

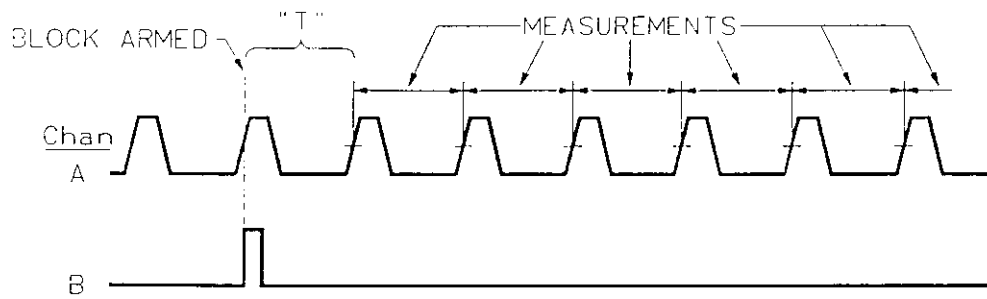

CONTINUOUS T. I. A

WF12\_H3

Figure 1-27. Continuous Time Interval | Edge Holdoff

#### DESCRIPTION OF DIAGRAM:

- A block of measurements can begin after a positive edge on Channel B.
- Measurement data is then collected as quickly as possible at the trigger events of Channel A. Five measurements are shown.
- The diagram shows an edge holdoff of a positive edge on Channel B. Other options are a positive or negative edge on Channel A or External Arm.
- The reference edge is time stamped, so all measurements in the block are referenced in time to the holdoff edge. Averaging of multiple blocks is supported.

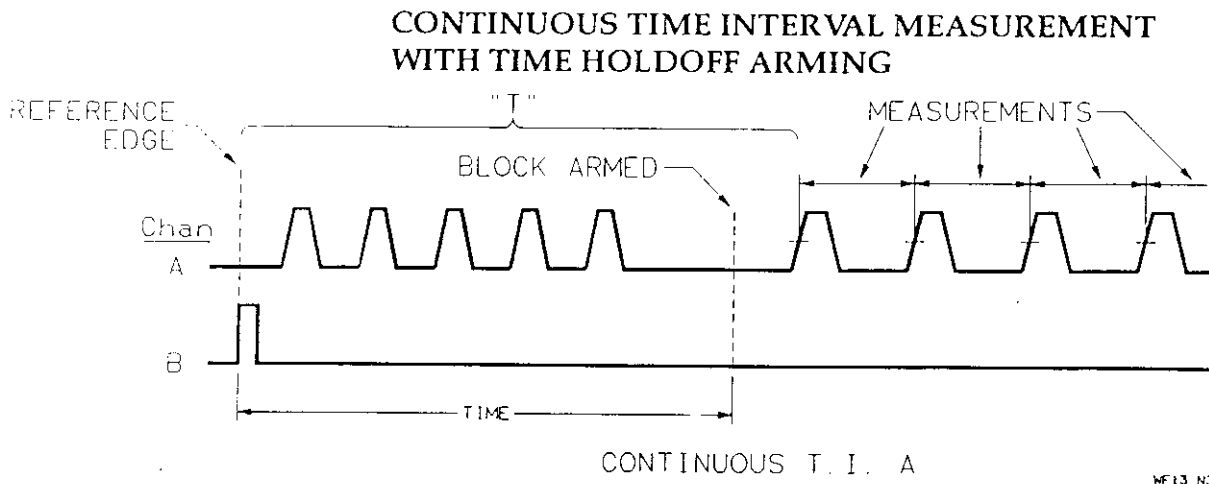

Figure 1-28. Continuous Time Interval | Time Holdoff

**DESCRIPTION OF DIAGRAM:**

- A block of measurements can begin after a selectable time delay. The start of the delay is referenced to a positive edge on Channel B.
- Measurement data is then collected as quickly as possible at the trigger events of Channel A. Three measurements are shown.
- The diagram shows the time delay referenced to a positive edge on Channel B. Other options are a positive or negative edge on Channel A or External Arm.
- The reference edge is time stamped, so all measurements in the block are referenced in time to the holdoff edge. Averaging of multiple blocks is supported.
- For Normal Measurement Mode:  
Range of Time = 2 ns to 8.0 s. Can be set with a resolution of 2 ns.
- For Fast Measurement Mode:  
Range of Time = 2 ns to 131  $\mu$ s. Can be set with a resolution of 2 ns.



### CONTINUOUS TIME INTERVAL MEASUREMENT WITH EVENT HOLDOFF ARMING

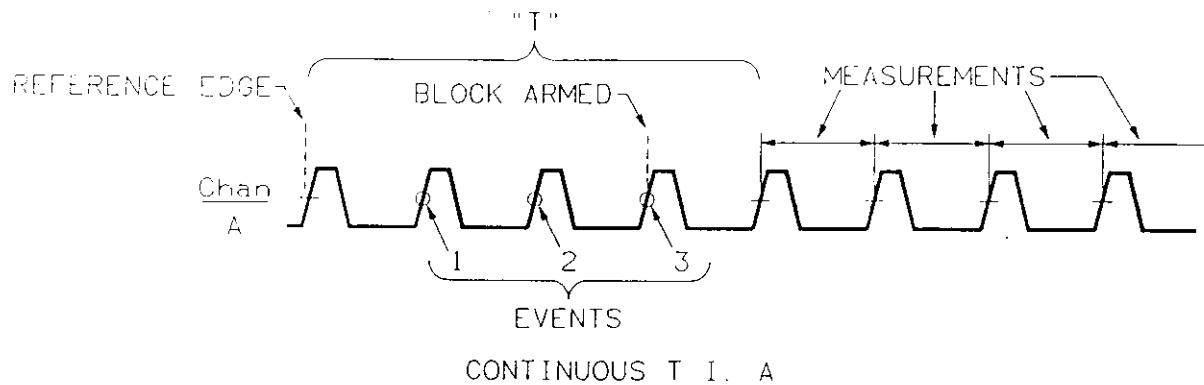

MF14\_N3

Figure 1-29. Continuous Time Interval | Event Holdoff

#### DESCRIPTION OF DIAGRAM:

- A block of measurements can begin after a selectable event delay. The start of the three-event delay is referenced to a positive edge on Channel A.
- Measurement data is then collected as quickly as possible at the trigger events of Channel A. Three measurements are shown.
- The diagram shows an event delay referenced to a positive edge on Channel A. Other options are a positive or negative edge on Channel B or External Arm.
- The delay events can be on Channel A or B.
- The reference edge is time stamped, so all measurements in the block are referenced to the holdoff edge. Averaging of multiple blocks is supported.
- For Normal Measurement Mode:
  - Range of Events = 0 to 4,000,000,000
- For Fast Measurement Mode:
  - Range of Events = 0 to 65,000

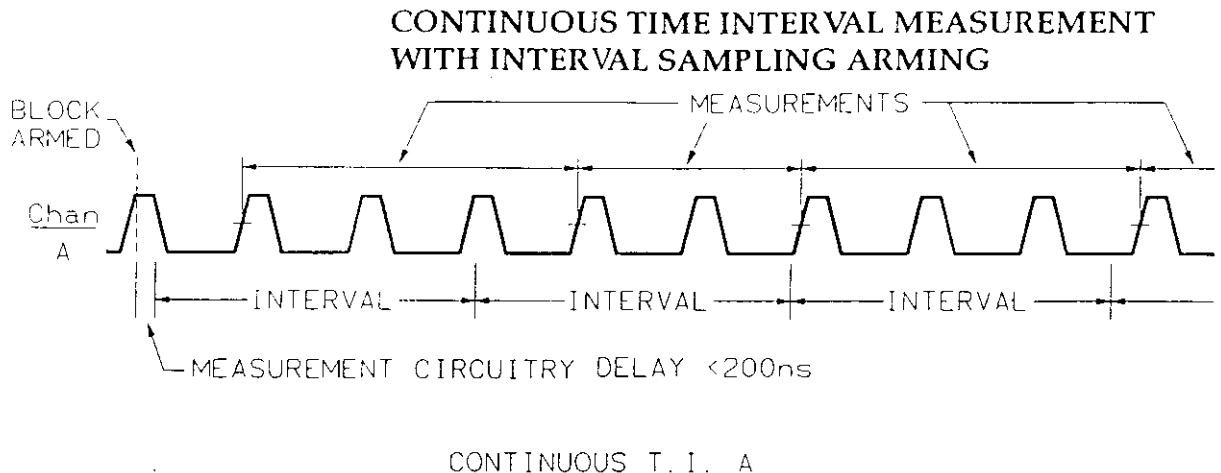

WF15\_N3

Figure 1-30. Continuous Time Interval | Interval Sampling

**DESCRIPTION OF DIAGRAM:**

- A block of measurements can begin as soon as the Analyzer is ready.
- Measurement data is then collected on the trigger event of Channel A after each specified sample interval.

The first measurement begins on the trigger event after the start of the first interval. Thereafter, measurements end on the trigger event following each interval. The sample interval is repetitive and asynchronous with the signal being measured. Three measurements are shown.

- For Normal Measurement Mode:  
Range of Interval = 100 ns to 8.0 s. Can be set with a resolution of 100 ns.
- For Fast Measurement Mode:  
Range of Interval = 100 ns to 131 μs. Can be set with a resolution of 100 ns.

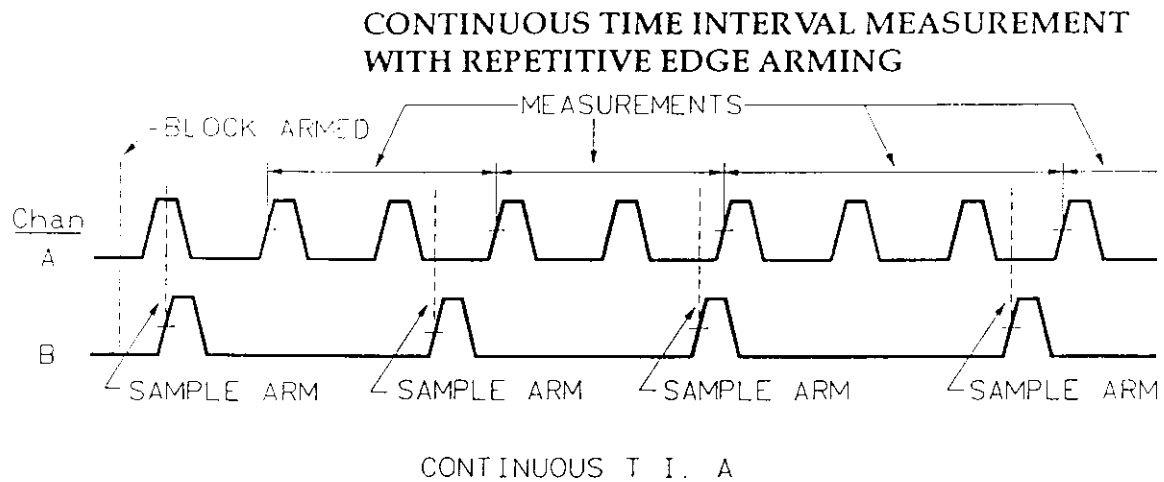

WF17\_N3

Figure 1-31. Continuous Time Interval | Repetitive Edge

#### DESCRIPTION OF DIAGRAM:

- A block of measurements can begin as soon as the Analyzer is ready.
- Measurement data is then collected after each positive edge on Channel B. One sample is collected per arming edge. Three measurements are shown.
- The diagram shows a sample arm of a positive edge on Channel B. Other options are a positive or negative edge on Channel A or External Arm.

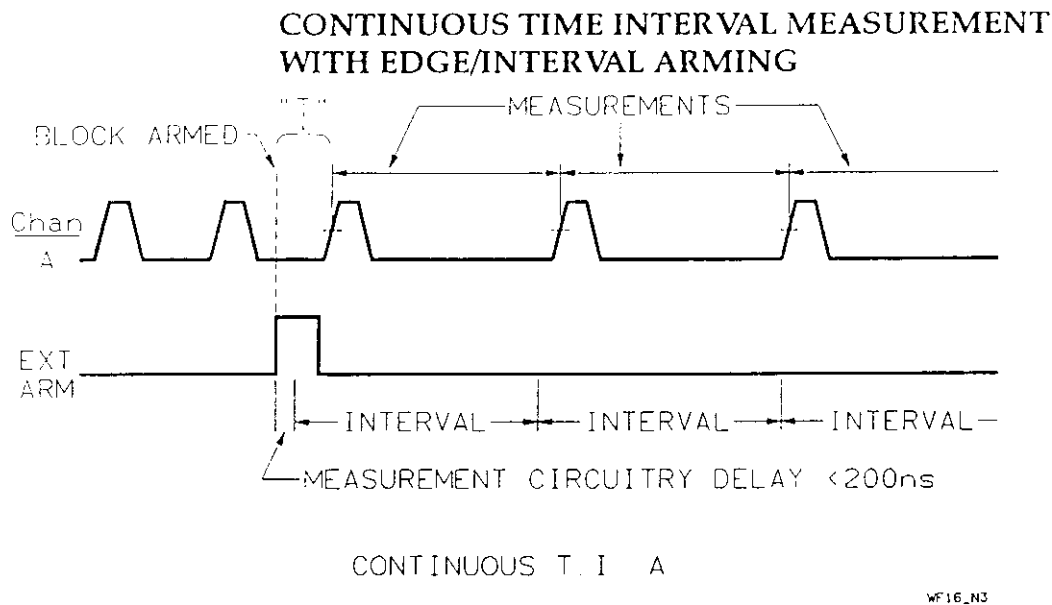

Figure 1-32. Continuous Time Interval | Edge/Interval

**DESCRIPTION OF DIAGRAM:**

- A block of measurements can begin after a positive edge on External Arm.
- Measurement data is then collected on the trigger event of Channel A after each specified sample interval.

The first sample is collected on the trigger event after the start of the first interval. Thereafter, measurements end on the trigger event following each interval. The sample interval is repetitive and asynchronous with the signal being measured. Two measurements are shown.

- The diagram shows an edge holdoff of a positive edge on External Arm. Other options are a positive or negative edge on Channel A or B.
- The reference edge is time stamped, so all measurements in the block are referenced in time to the holdoff edge. Averaging of multiple blocks is supported.

- For Normal Measurement Mode:

Range of Interval = 100 ns to 8.0 s. Can be set with a resolution of 100 ns.

- For Fast Measurement Mode:

Range of Interval = 100 ns to 131  $\mu$ s. Can be set with a resolution of 100 ns.

**±Time Interval  
Measurements**

**±TIME INTERVAL MEASUREMENT  
WITH AUTOMATIC ARMING**

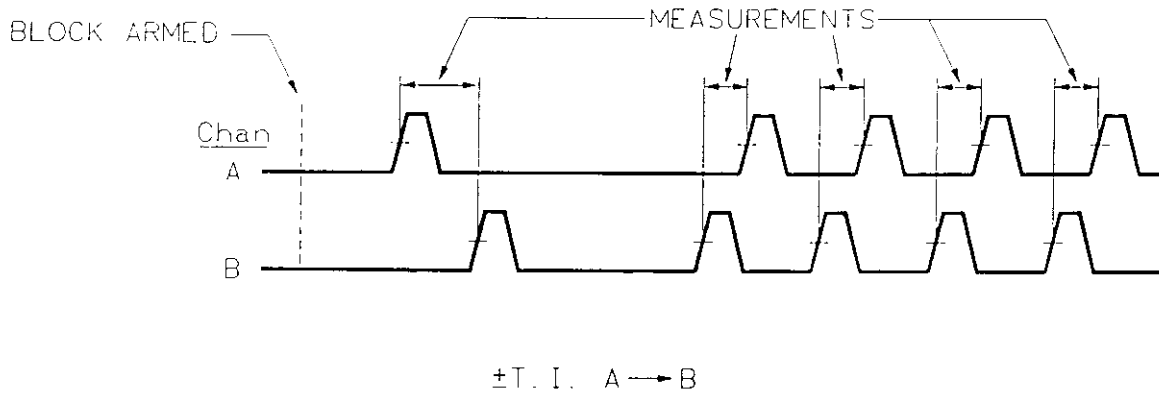

WF18\_N3

Figure 1-33. ± Time Interval | Automatic

**DESCRIPTION OF DIAGRAM:**

- A block of measurements can begin as soon as the Analyzer is ready.
- Measurement data is collected as quickly as possible at the trigger events of the signals being measured. Five measurements are shown.

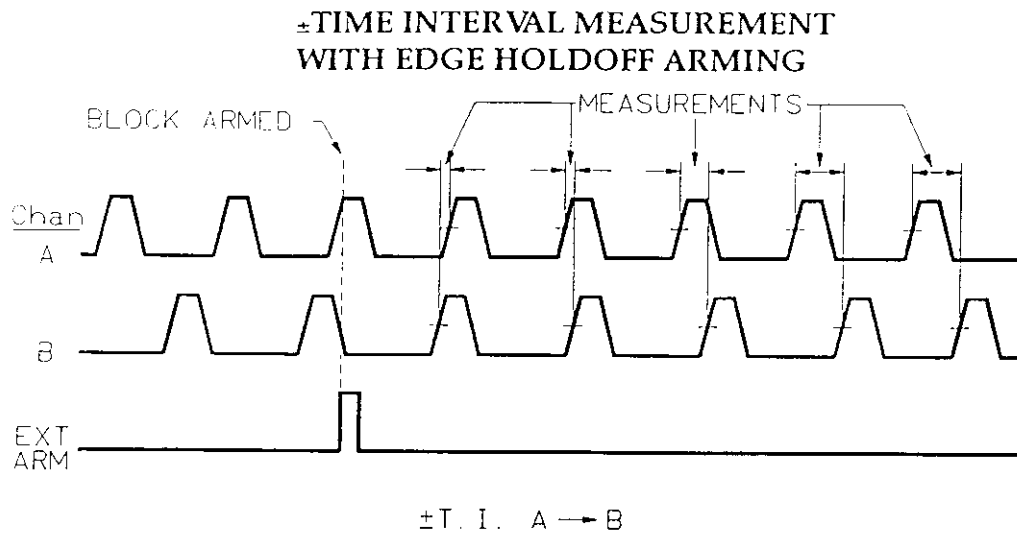
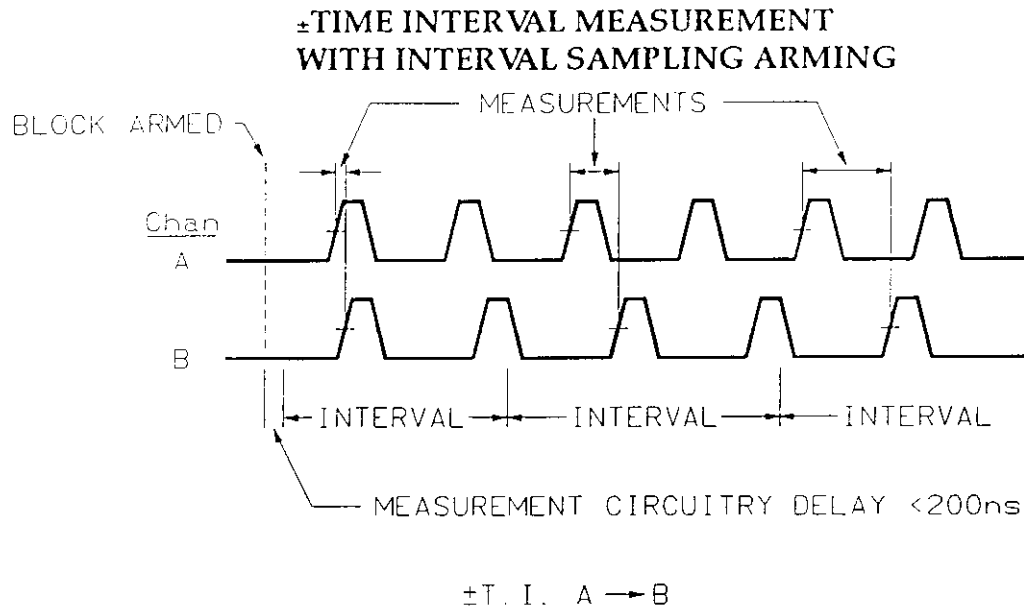

Figure 1-34. ±Time Interval | Edge Holdoff

**DESCRIPTION OF DIAGRAM:**

- A block of measurements can begin after a positive edge on External Arm.
- Measurement data is then collected as quickly as possible at the trigger events of the signals being measured. Five measurements are shown.
- The diagram shows an edge holdoff of a positive edge on External Arm. Other options are a positive or negative edge on Channel A or B.



WF20\_N3

Figure 1-35. ± Time Interval | Interval Sampling

**DESCRIPTION OF DIAGRAM:**

- A block of measurements can begin as soon as the Analyzer is ready.
- For ±Time Interval measurements, one measurement is taken per interval when the specified sample interval is longer than the time interval measured. If the sample interval is shorter than the time interval measured, the measurement data will be collected just as it is for ±Time Interval measurements using the Automatic arming mode. In the example shown above, the sample interval sets the time between measurements. The sample interval is repetitive and asynchronous with the signal being measured. Three measurements are shown.
- For Normal Measurement Mode:  
Range of Interval = 100 ns to 8.0 s. Can be set with a resolution of 100 ns.
- For Fast Measurement Mode:  
Range of Interval = 100 ns to 131 μs. Can be set with a resolution of 100 ns.



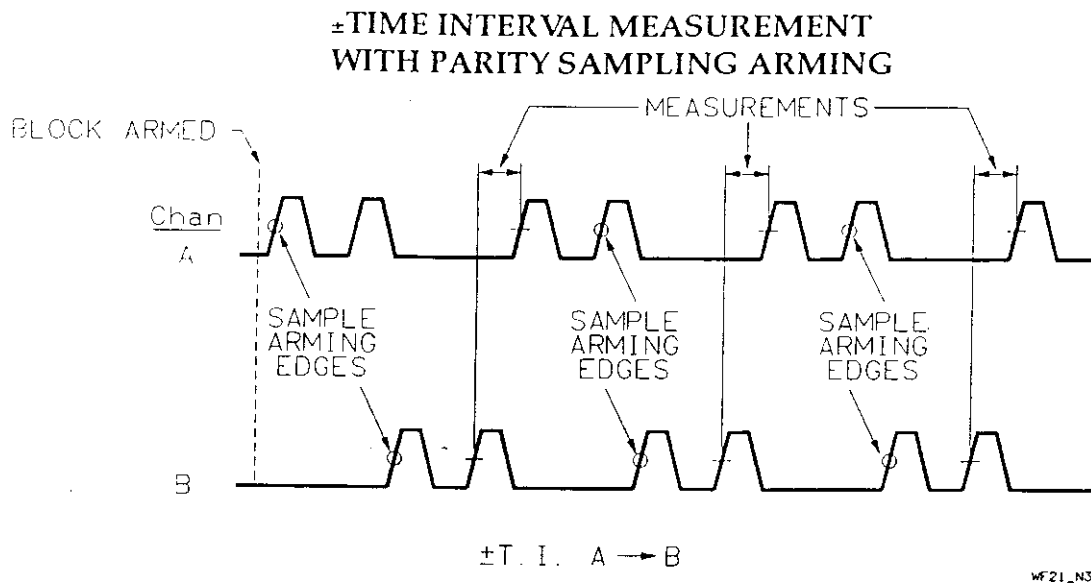

Figure 1-36. ±Time Interval | Parity Sampling

**DESCRIPTION OF DIAGRAM:**

- A block of measurements can begin as soon as the Analyzer is ready.
- For ±Time Interval measurements, one measurement is collected following a trigger event on each of the two measurement channels. Three measurements are shown.

**NOTE**

*This diagram shows the operation of this arming mode and is not an example of an application. This arming mode is intended for a set of signals that do not go out of phase more than 360 degrees (that is, on average, there should be the same number of edges on Channel A as on Channel B).*

**NOTE**

---

*For Parity Sampling (Parity = two sample arming edges)—*

*During an approximately 200 ns interval after every measurement (this is when the HP 5372A is storing the measurement data to memory), detection of the sample arming edges operates according to the following rules:*

- 1. If an unequal number of edges occur on the two input channels (for example, 2 on A and 0 on B, 1 on A and 0 on B, or 2 on A and 1 on B), only one more edge on the input channel with fewer edges (Channel B in this example) is needed after the 200 ns interval, to satisfy the parity condition required for the next measurement.*
  - 2. If an equal number of edges occur on the two measurement channels (for example, 1 on A and 1 on B, or 2 on A and 2 on B), one more edge on each of the two measurement channels is required after the 200 ns interval to satisfy the parity condition required for the next measurement.*
-

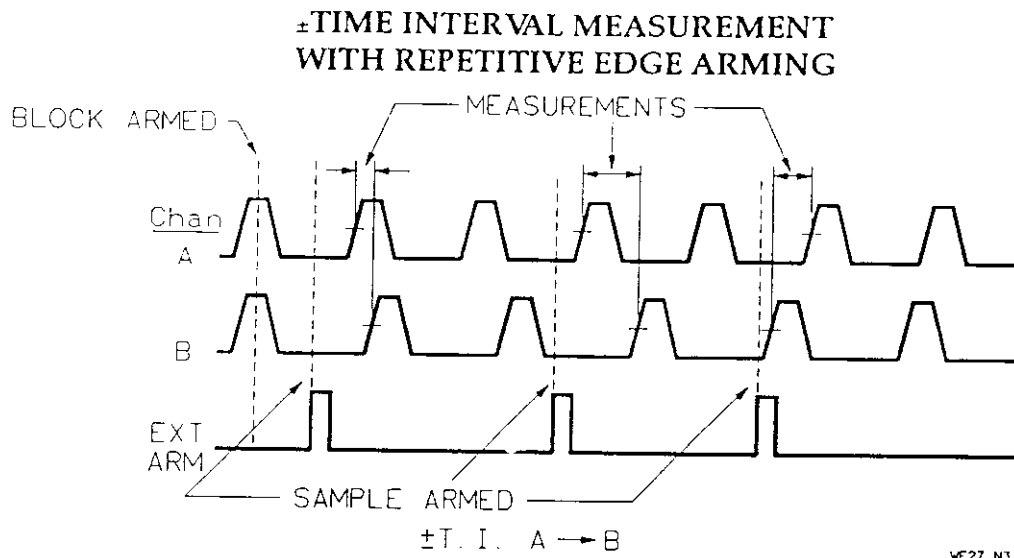

Figure 1-37. ± Time Interval | Repetitive Edge

#### DESCRIPTION OF DIAGRAM:

- A block of measurements can begin as soon as the Analyzer is ready.
- Measurement data for one measurement is then collected after each positive edge on External Arm. There is one measurement per arming edge. Three measurements are shown.
- The diagram shows a sample arm of a positive edge on External Arm. Other options are a positive or negative edge on Channel A or B.

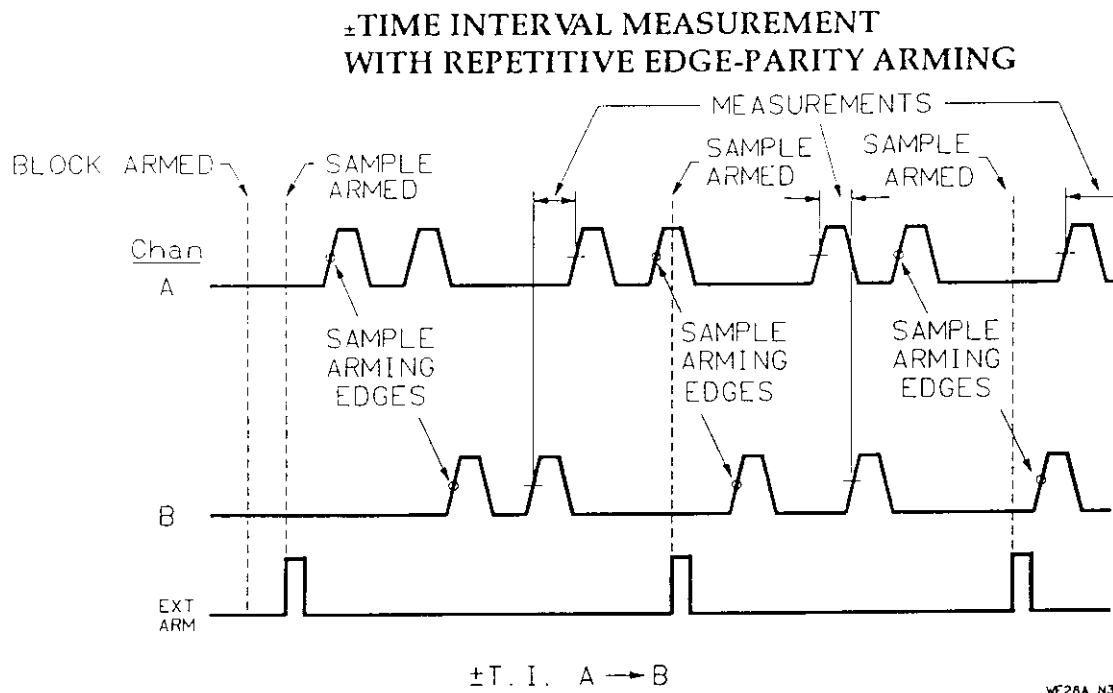

Figure 1-38. ± Time Interval | Repetitive Edge-Parity

**DESCRIPTION OF DIAGRAM:**

- A block of measurements can begin as soon as the Analyzer is ready.
- Measurement data for one measurement is then collected after a positive edge on External Arm and a trigger event on each of the two measurement channels. Two measurements are shown.
- The diagram shows a sample arm of a positive edge on External Arm. Other options are a positive or negative edge on Channel A or B.

**NOTE**

*This diagram shows the operation of this arming mode and is not an example of an application. This arming mode is intended for a set of signals that do not go out of phase more than 360 degrees (that is, on average, there should be the same number of edges on Channel A, as on Channel B).*

**NOTE**

---

*For Parity Sampling (Parity = two sample arming edges)—*

*During an approximately 200 ns interval after every measurement, detection of the sample arming edges operates according to the following rules:*

- 1. If an unequal number of edges occur on the two input channels (for example, 2 on A and 0 on B, or 1 on A and 0 on B, or 2 on A and 1 on B), only one more edge on the input channel with fewer edges (Channel B in this example) is needed after the 200 ns interval, to satisfy the parity condition required for the next measurement.*
  - 2. If an equal number of edges occur on the two measurement channels (for example, 1 on A and 1 on B, or 2 on A and 2 on B), one more edge on each of the two measurement channels is required after the 200 ns interval to satisfy the parity condition required for the next measurement.*
-

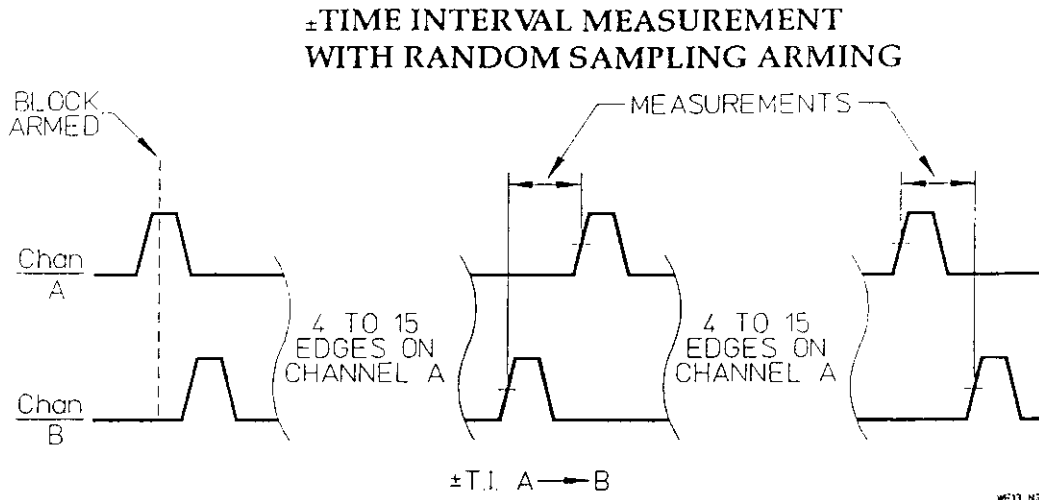

Figure 1-39. ±Time Interval | Random Sampling

**DESCRIPTION OF DIAGRAM:**

- A block of measurements can begin as soon as the Analyzer is ready.
- Measurement data for each measurement is then collected after a random number of edges on Channel A. The random number of edges on Channel A varies from 4 to 15 between each measurement.
- HP 5372A always randomizes on Channel A.
- Random sampling is only valid up to a 100 MHz rate. For more information, refer to "Arming," chapter 5.

**NOTE**

*The pseudo-random sequence generator operates in a "free-run" mode. Because of this, the first measurement in a sequence can occur after fewer than four edges on Channel A. For the measurements that follow, the pseudo-random sequence generator arms a measurement every six to seventeen edges on Channel A.*

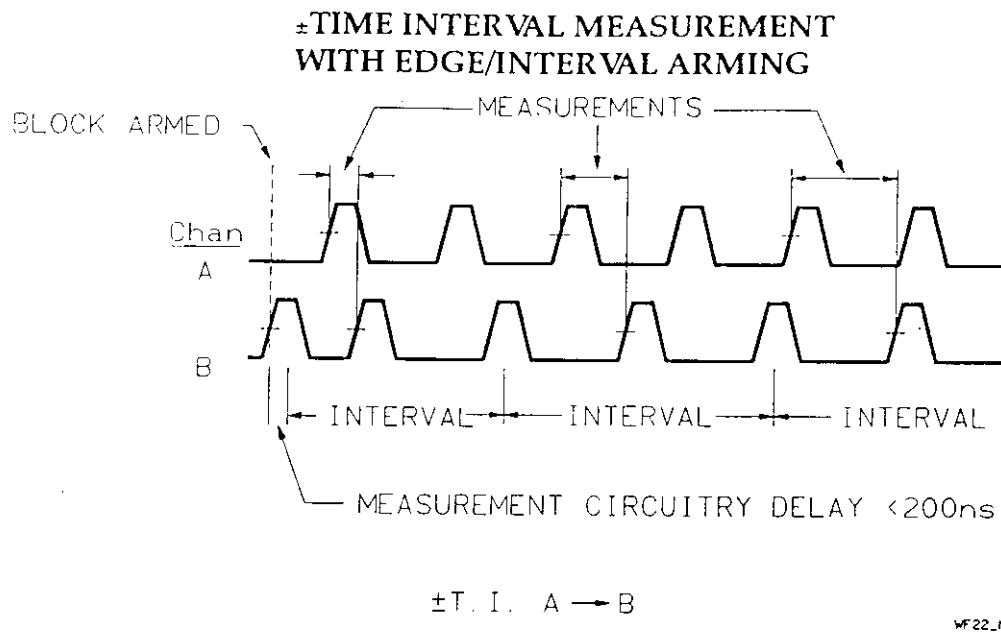

Figure 1-40. ±Time Interval | Edge/Interval

#### DESCRIPTION OF DIAGRAM:

- A block of measurements can begin after a positive edge on Channel B. The start is delayed until the arming edge occurs.
- For ±Time Interval measurements, one measurement is taken per interval when the specified sample interval is longer than the time interval measured. If the sample interval is shorter than the time interval measured, the measurement data will be collected just as it is for ±Time Interval measurements using the Automatic arming mode. In the example shown above, the sample interval sets the time between measurements. The sample interval is repetitive and asynchronous with the signal being measured. Three measurements are shown.
- The diagram shows an edge holdoff of a positive edge on Channel B. Other options are a positive or negative edge on Channel A or External Arm.

- For Normal Measurement Mode:

Range of Interval = 100 ns to 8.0 s. Can be set with a resolution of 100 ns.

- For Fast Measurement Mode:

Range of Interval = 100 ns to 131  $\mu$ s. Can be set with a resolution of 100 ns.



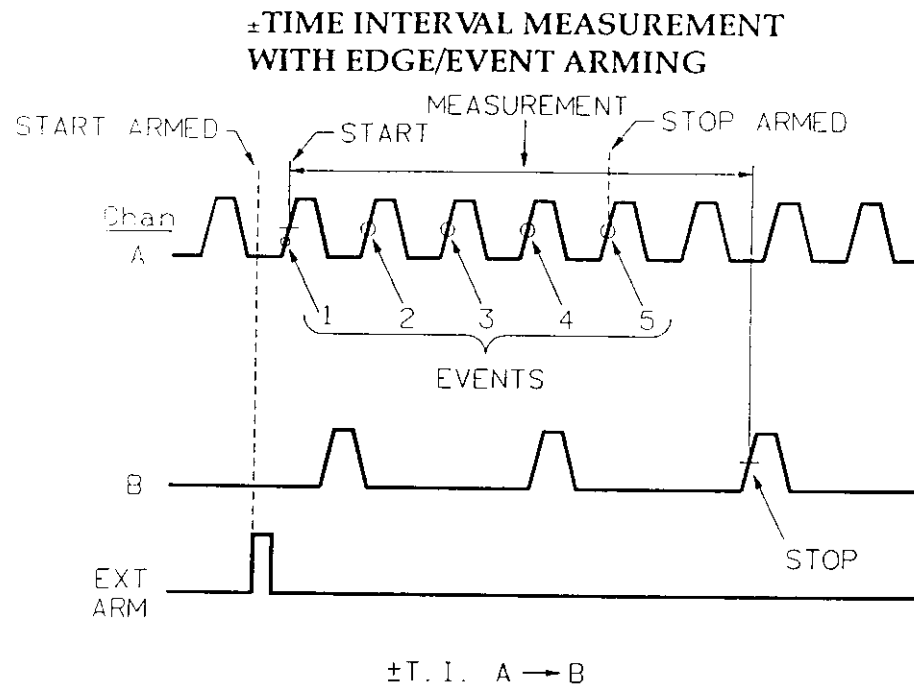

Figure 1-41. ± Time Interval | Edge/Event

#### DESCRIPTION OF DIAGRAM:

- Measurement can begin after a positive edge on External Arm.
- Measurement starts on the next trigger event on either of the two measurement channels after the arming edge.
- Measurement ends on the trigger event of the other measurement channel following the specified number of events on Channel A.
- The diagram shows an edge holdoff of a positive edge on External Arm. Other options are a positive or negative edge on Channel A or B.
- The delay events can be on Channel A or B.
- The maximum number of measurements per block is 1. Configurations such as 100 blocks of 1 measurement are allowed.
- For Normal Measurement Mode:  
Range of Events = 0 to 2,000,000,000

**NOTE**

---

*Total period of Stop Arm events should not exceed 4.0 s.*

---

- For Fast Measurement Mode:  
Range of Events = 0 to 32,500

**NOTE**

---

*Total period of Stop Arm events should not exceed 65  $\mu$ s.*

---

### ±TIME INTERVAL MEASUREMENT WITH EDGE/PARITY ARMING

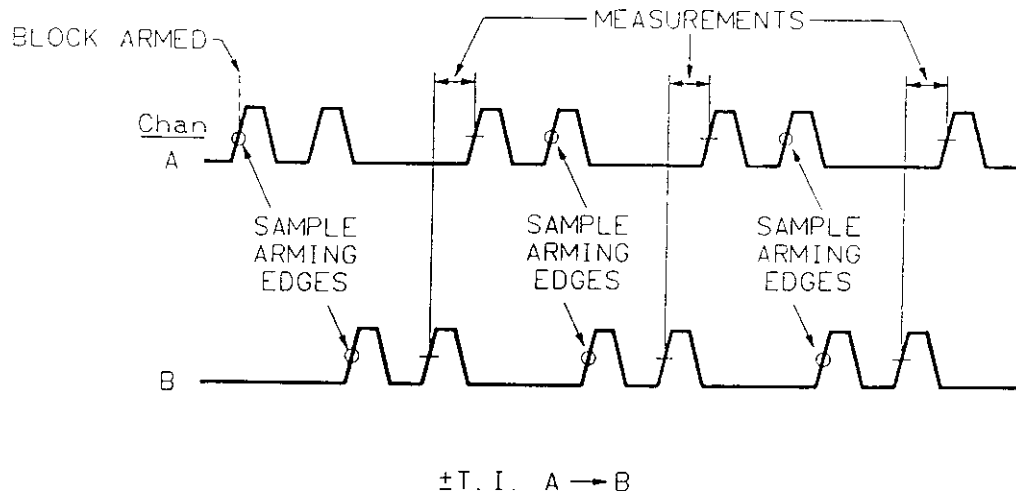

Figure 1-42. ± Time Interval | Edge/Parity

#### DESCRIPTION OF DIAGRAM:

- A block can begin after a positive edge on Channel A.
- For ±Time Interval measurements, one measurement is collected following a trigger event on each of the two measurement channels. Three measurements are shown.
- The diagram shows an edge holdoff of a positive edge on Channel A. Other options are a positive or negative edge on Channel B or External Arm.

#### NOTE

*This diagram shows the operation of this arming mode and is not an example of an application. This arming mode is intended for a set of signals that do not go out of phase more than 360 degrees (that is, on average, there should be the same number of edges on Channel A, as on Channel B).*

**NOTE**

---

*For Parity Sampling (Parity = two sample arming edges)—*

*During an approximately 200 ns interval after every measurement, detection of the sample arming edges operates according to the following rules:*

- 1. If an unequal number of edges occur on the two input channels (for example, 2 on A and 0 on B, or 1 on A and 0 on B, or 2 on A and 1 on B), only one more edge on the input channel with fewer edges (Channel B in this example) is needed after the 200 ns interval, to satisfy the parity condition required for the next measurement.*
  - 2. If an equal number of edges occur on the two measurement channels (for example, 1 on A and 1 on B, or 2 on A and 2 on B), one more edge on each of the two measurement channels is required after the 200 ns interval to satisfy the parity condition required for the next measurement.*
-

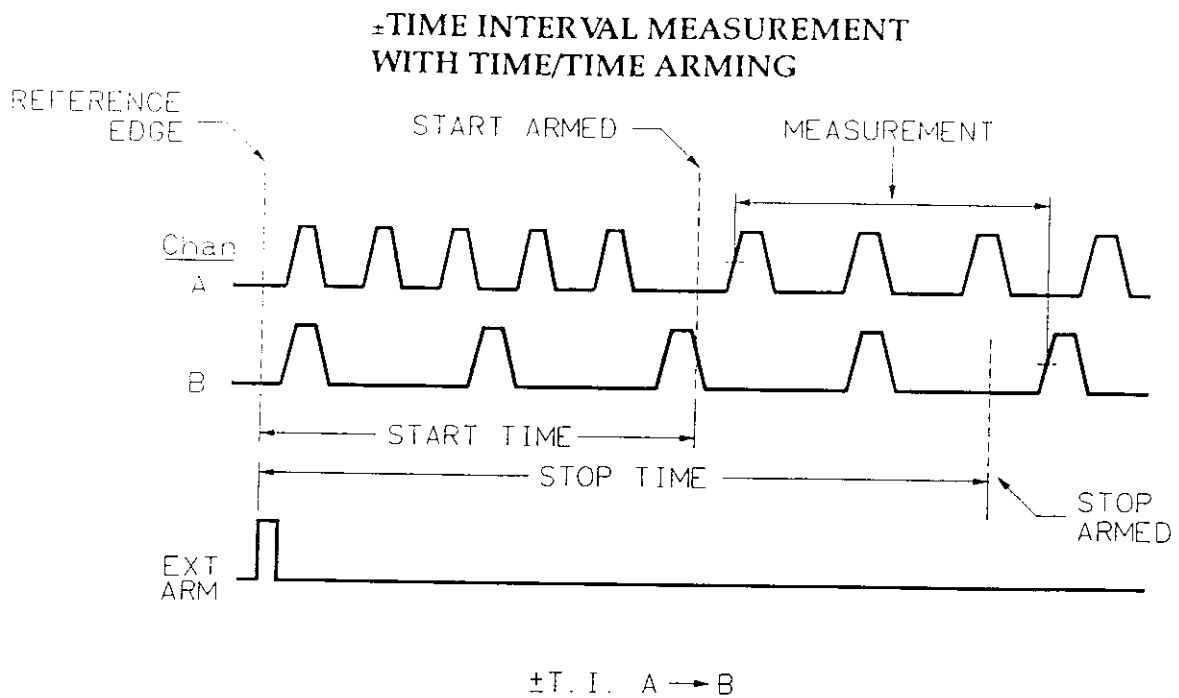

WF25\_N3

Figure 1-43. ±Time Interval | Time/Time

#### DESCRIPTION OF DIAGRAM:

- Measurement can begin after a positive time delay. The start of the time delay is referenced to a positive edge on External Arm.
- Measurement starts on the next trigger event following the end of the start-time delay.
- Measurement ends on the trigger event following the end of the stop-time delay. The start- and stop-time delays are referenced to the same arming edge (the External Arm edge in this example).
- The diagram shows the time delay referenced to a positive edge on External Arm. Other options are a positive or negative edge on Channel A or B.
- The maximum number of measurements per block is 1. Configurations such as 100 blocks of 1 measurement are allowed.
- For Normal Measurement Mode:

Range of Time = 2 ns to 8.0 s. Can be set with a resolution of 2 ns.

**NOTE**

---

*The time of the interval measured must not exceed  
 $\pm 4.0$  s.*

---

- For Fast Measurement Mode:

Range of Time = 2 ns to 131  $\mu$ s. Can be set with a resolution of 2 ns.

**NOTE**

---

*The time of the interval measured must not exceed  
 $\pm 65$   $\mu$ s.*

---

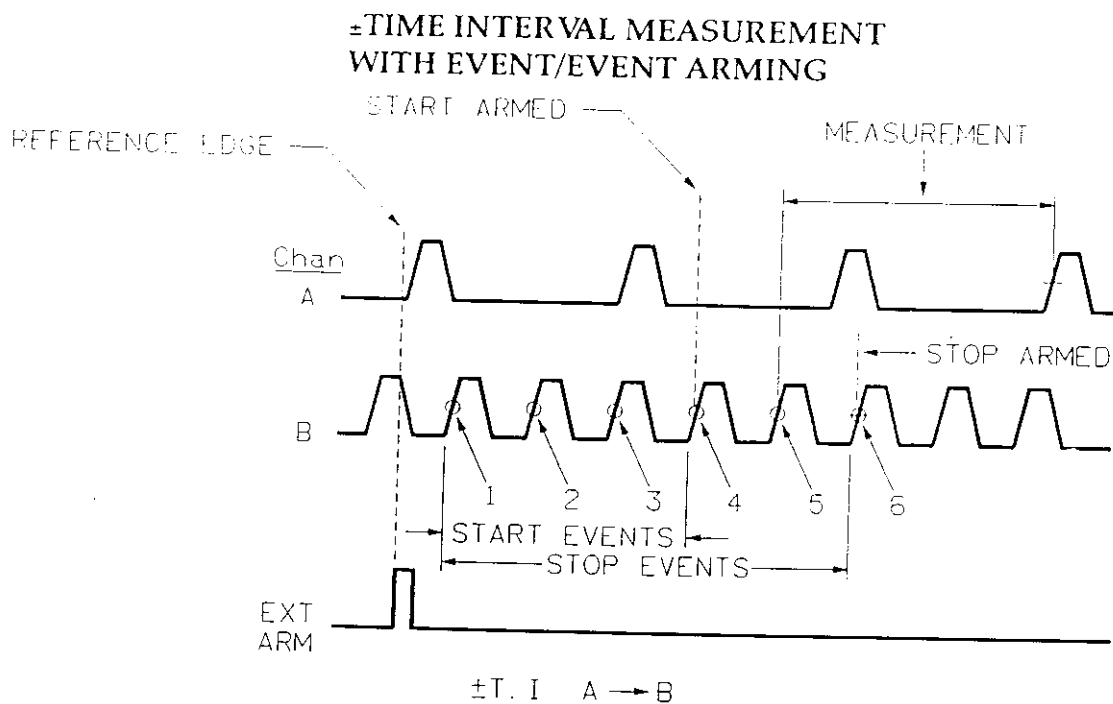

Figure 1-44. ±Time Interval | Event/Event

#### DESCRIPTION OF DIAGRAM:

- A measurement can begin after an event delay. The start of the delay is referenced to a positive edge on External Arm.
- A measurement starts on the trigger event following the end of the start-event delay. In this example, the start delay is four events.
- The measurement ends on the trigger event following the end of the stop-event delay. In this example, the stop-delay is six events. The start- and stop-event delays are referenced to the same arming edge.
- The diagram shows the event delays referenced to a positive edge on External Arm. Other options are a positive or negative edge on Channel A or B.
- The delay events can be on Channel A or B.
- The maximum number of measurements per block is 1. Configurations such as 100 blocks of 1 measurement are allowed.
- For Normal Measurement Mode:

Range of Events = 0 to 4,000,000,000

**NOTE**

---

*The time of the interval measured must not exceed  $\pm 4.0$  s.*

---

- For Fast Measurement Mode:

Range of Events = 0 to 65,000

**NOTE**

---

*The time of the interval measured must not exceed  $\pm 65$   $\mu$ s.*

---



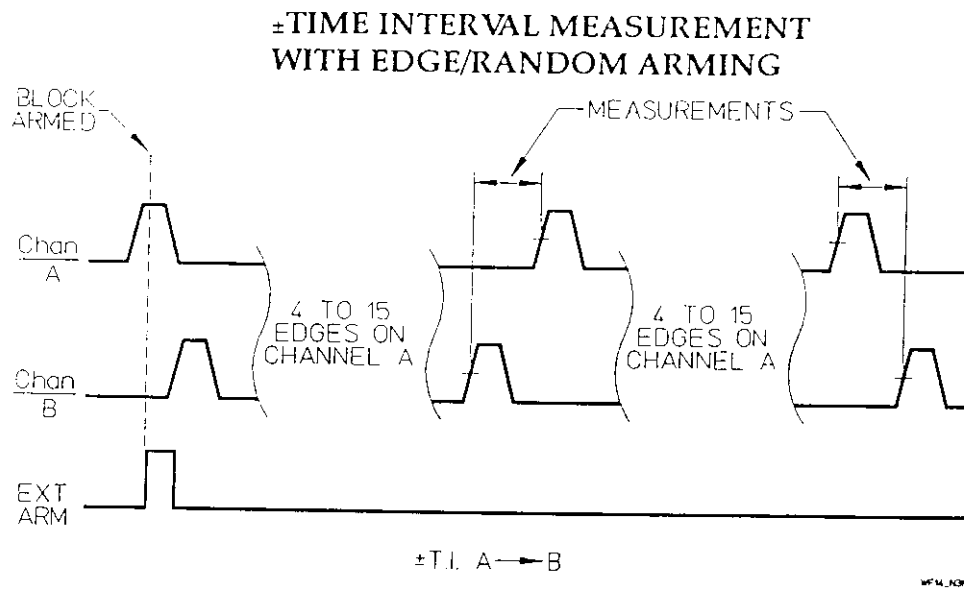

Figure 1-45. ±Time Interval | Edge/Random

#### DESCRIPTION OF DIAGRAM:

- A block of measurements can begin after a positive edge on External Arm. The measurement start is delayed until the arming edge occurs.
- Measurement data is then collected for each measurement after a random number of edges on Channel A. The random number of edges on Channel A varies from 4 to 15 between each measurement.
- The diagram shows an edge holdoff of a positive edge on External Arm. Other options are a positive or negative edge on Channel A or B.
- HP 5372A always randomizes on Channel A.
- Random sampling is only valid up to a 100 MHz rate. For more information, refer to "Arming," chapter 5.

#### NOTE

*The pseudo-random sequence generator operates in a "free-run" mode. Because of this, the first measurement in a sequence can occur after fewer than four edges on Channel A. For the measurements that follow, the pseudo-random sequence generator arms a measurement every six to seventeen edges on Channel A.*



MEMBERSHIP



## Contents of Chapter

---

Chapter Overview .....	2-1
How the HP 5372A Measures Frequency and Period .....	2-1
Time and Events .....	2-1
A Sample .....	2-2
Sampling .....	2-3
When are Samples Taken? .....	2-3
Sampling Interval .....	2-5
Deciding How Often To Take Samples .....	2-6
A Block .....	2-7
Arming .....	2-7
Frequency Resolution .....	2-8
Frequency Range .....	2-9
Period Range .....	2-9
Frequency and Period Measurements Described .....	2-10
Frequency and Period Channel Choices .....	2-10
Single-Channel .....	2-11
Two-Channel .....	2-11
Two-Result Measurement .....	2-11
Ratio Measurement .....	2-11
Sum Measurement .....	2-12
Difference Measurement .....	2-12
Frequency and Period Arming Modes .....	2-13
Measurements Referenced to the Block Arming Edge .....	2-14
Averaged Results for Frequency/Period Measurements .....	2-15
Frequency and Period Arming Mode Examples .....	2-15
Frequency Measurement with Automatic Arming .....	2-16
Frequency Measurement with Edge Holdoff Arming .....	2-17
Frequency Measurement with Time Holdoff Arming .....	2-18
Frequency Measurement with Event Holdoff Arming .....	2-19
Frequency Measurement with Interval Sampling Arming .....	2-20
Frequency Measurement with Time Sampling Arming .....	2-21
Frequency Measurement with Cycle Sampling Arming .....	2-22
Frequency Measurement with Edge Sampling Arming .....	2-24
Frequency Measurement with Edge/Interval Arming .....	2-25
Frequency Measurement with Edge/Time Arming .....	2-26
Frequency Measurement with Edge/Edge Arming .....	2-27

Frequency Measurement with Edge/Cycle Arming .....	2-28
Frequency Measurement with Edge/Event Arming .....	2-30
Frequency Measurement with Time/Interval Arming .....	2-32
Frequency Measurement with Time/Time Arming .....	2-34
Frequency Measurement with Event/Interval Arming .....	2-36
Frequency Measurement with Event/Event Arming .....	2-38
Frequency Measurement with Externally Gated Arming .....	2-40

# FREQUENCY/PERIOD MEASUREMENTS

---

## CHAPTER OVERVIEW

This chapter describes the following:

- How the HP 5372A makes measurements
- Data collection for frequency and period measurements
- Preview of arming
- Input channel options
- An illustration of each of the Frequency/Period arming modes

## HOW THE HP 5372A MEASURES FREQUENCY AND PERIOD

It is helpful when learning to use the HP 5372A to understand how it makes measurements. This information will make your specific measurement setup much easier to accomplish. Before covering the specifics of frequency and period measurements, you need to start with the basics of what kind of data the HP 5372A collects and when it is collected.

### Time and Events

Only two kinds of data are collected by the HP 5372A no matter what type of measurement is being made (Time Interval, Pulse Width, Frequency, etc.).

The two kinds of data collected are:

- time
- events

The HP 5372A has a 500 MHz internal clock for measuring the time over which measurements occur. The clock is used as a stopwatch to measure the time of each measurement.

The events (trigger events) are counted for each measurement as well.

From this time and event data, measurement results can be calculated.

**TECHNICAL COMMENT**



*A trigger event is a specific voltage on a rising or falling slope of an input signal that will trigger the HP 5372A to initiate some action. This action can be to arm a measurement, begin a measurement, or end a measurement. Refer to "Input Menu," chapter 8 for more information on how a trigger event is specified.*

**A Sample**

Time and event data for a measurement is periodically captured by the HP 5372A. This capture of data consists of reading the accumulated time of the measurement from a time counter and the number of events that have occurred from an event counter. The two values are stored to internal memory. These two values constitute a SAMPLE.

The HP 5372A can continue to accumulate time and events while a sample is saved in memory. It is only at the end of the measurement sequence, that is, after the samples have been collected for a number of measurements, that the data capture ends and the measurement results are calculated. This provides for continuous frequency and period measurements. The word "continuous" conveys the fact that there is no pause between measurements. The end of one measurement is the beginning of the next. Two consecutive samples define one measurement. This is seen in Figure 2-1.

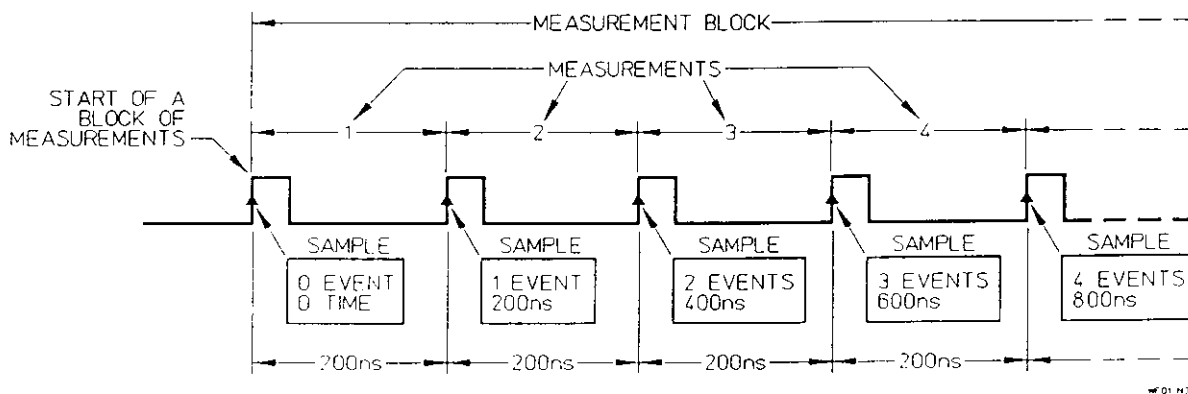

Figure 2-1. Measurements are Made from Samples



To review:

- Time data is the elapsed time from the beginning of the first measurement to when a sample is collected.
- Event data is the number of trigger events that have occurred from the beginning of the first measurement to when a sample is collected.

## Sampling

The term, "SAMPLING," describes the process of collecting a sample.

There are two important elements of sampling to keep in mind when making frequency and period measurements:

1. The sampling is synchronized to the signal being measured. That is, a sample can only be taken at a trigger event of the measurement signal.

AND

2. The sampling rate has an upper limit. Sampling can happen on every trigger event of the measurement signal, depending on the rate at which events are occurring and the arming mode you specify. More about this later.

## When are Samples Taken?

The point at which samples of your signal will be taken is a function of the following:

- The rate at which events are occurring helps determine when samples are taken. When events occur at a rate less than 10 MHz (13.3 MHz in Fast Mode), you can collect a sample (time and event data) at every trigger event. (*Figure 2-1* shows this situation where there is time data and event data for every trigger event.)

TECHNICAL COMMENT



If events are occurring at a rate faster than the measurement hardware of the HP 5372A is able to capture and store the information to memory, not every trigger event will have associated time and event data. This is because new samples cannot be captured while a previous sample is being stored. That is, when the event rate exceeds 10 MHz, a new sample will be collected only at the trigger event following the storing of a previous sample to memory. Events occurring while a sample is being stored will be counted but will have no time data associated with them. An example of this is shown in Figure 2-2.

For frequency and period measurements when the event rate exceeds 10 MHz, individual measurements will have a duration greater than one period of the measurement signal. For example, a frequency measurement may be made over 5, 10, 20, 1000, or more, periods of the signal.

This is a simplified description of what composes a frequency measurement:

The raw data for a frequency measurement consists of a time and event count for the start of a measurement and a time and event count for the end of a measurement. From this is calculated the time over which the measurement was made and the number of trigger events that occurred during that time. Then dividing the delta events by the delta time provides the final frequency result. See the example in Figure 2-2.

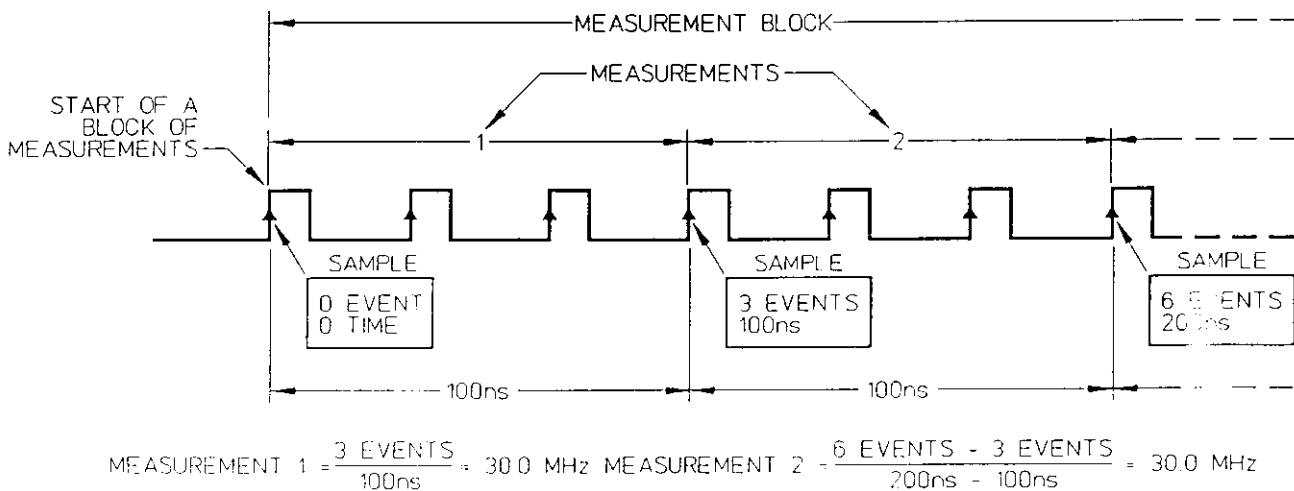

HP 02, N3M

Figure 2-2. Trigger Events Occurring Faster than They can be Stored

- The selected arming mode helps determine when samples are taken. An arming mode can specify when the HP 5372A will collect the time and event samples. In *Figure 2-3*, an arming mode is introduced to show how it can control when samples are taken. In this case, a sample is captured only after a specified time interval elapses. The full range of control possible with the arming modes is illustrated later in this chapter. There is an example for each arming mode available for frequency and period measurements. (Refer to *Figure 2-4* to see the Function menu setup for the arming mode example in *Figure 2-3*.)

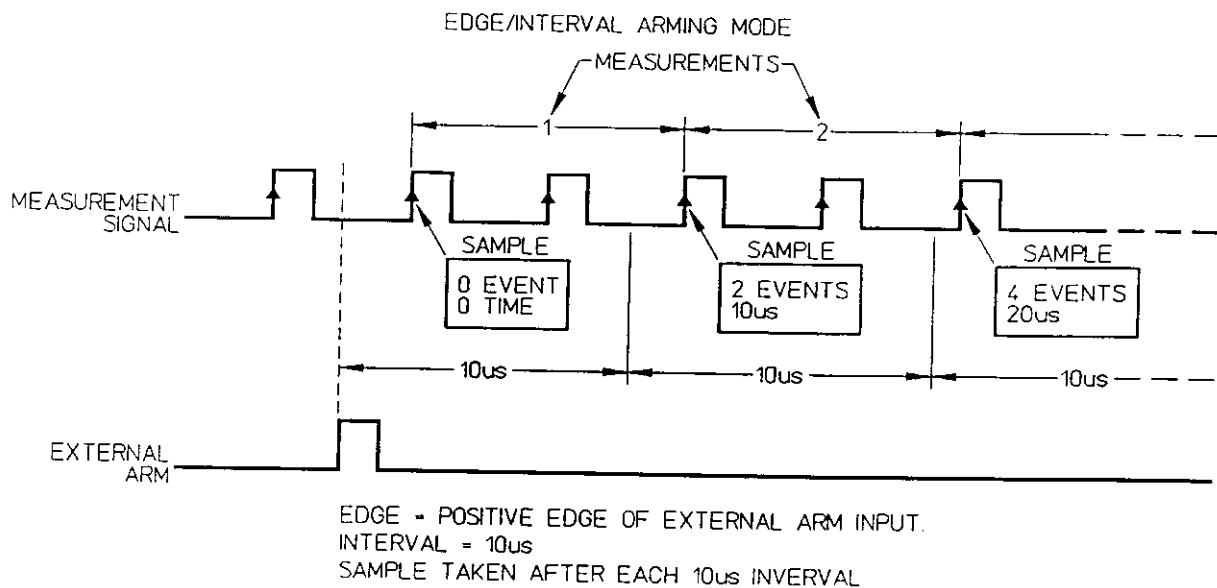

*Figure 2-3. Arming Mode can Specify When Data is Collected*

### Sampling Interval

As noted above, the rate at which events are occurring on the input signal is one factor in determining when samples are taken. Another is the selected arming mode that can set the time between samples. But, it is the time required by the HP 5372A to store a sample to memory that sets the minimum time between samples. This is also called, "the minimum sampling interval."

The HP 5372A provides a choice of two minimum sampling intervals. The selection is made on the System menu at the field labeled, "Measurement Mode."

The sampling interval can be set to "Normal" or "Fast." The default measurement mode is Normal. Normal mode provides a minimum sampling interval of 100 ns. The Fast mode

provides a minimum sampling interval of 75 ns. You should be aware that when using the Fast mode, the range of measurement is limited from what it is for Normal. The limits are included with the arming mode descriptions in this chapter.

---

### TECHNICAL COMMENT

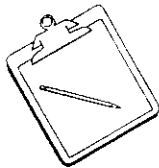

*When you select the Normal or Fast measurement mode, you are choosing between two different data sizes for the time and event samples. Normal mode uses the full 32 bits of counting register data to provide the maximum measurement range of time and frequency. In contrast, Fast mode uses only 16 bits of register data to allow a faster sample rate, but a decreased range of time and frequency measurements.*

*Fast mode limits the minimum frequency measurement to 8 kHz and limits the maximum period measurement to 131  $\mu$ s. In Normal mode the minimum frequency is 0.125 Hz and the maximum period measurement is 8.0 s. Unless a faster sampling rate is critical to your measurement, use Normal mode. The measurement limits for Normal and Fast modes are described in this chapter and throughout this manual.*

---

## Deciding How Often To Take Samples

When making frequency and period measurements with trigger events occurring at a rate slower than the sampling rate, every trigger event could have a time and event count stored away for it. This may be desirable, depending on your signal to be measured and what you want to learn from your measurements.

For example, if you were to make 8,191 measurements on a 10 MHz signal using Automatic arming (which provides a sample every 100 ns), you will capture 819  $\mu$ s of signal data ( $8,191 \times 100$  ns). Depending on what you want to learn from the signal, this amount of data could be sufficient, or it might represent only a very small portion of what you want to capture.

Other arming modes let you specify when samples are taken. For example, one arming mode gives you the ability to capture a sample from once every 100 ns to once every 8.0 s. The following paragraphs go into more detail about this and other arming modes.

**A Block** A "block" of measurements is one or more measurements collected in a group. The importance of a block is that you can specify a block holdoff condition which must be satisfied prior to the capture of each block of measurement data. After the holdoff condition is met, the instrument cycles repeatedly through a two part sampling process: arming a sample and capturing a sample, until all measurements in the block are acquired. The next section describes how arming lets you first set conditions for a block of measurements, and then for each measurement within the block.

**Arming** Arming gives you control over when the HP 5372A starts a measurement, or block of measurements, and when it ends a measurement. The size of the block and the number of measurements in a block are specified on the Function menu.

Arming specifies the conditions which must be satisfied before a block of measurements can begin, and then before each sample within that block can be collected.

1. A block of measurements can be delayed, or held off, until:
  - a specified edge of an input signal
  - a reference edge occurs, followed by a specified elapsed time
  - a reference edge occurs, followed by a specified number of events

AND THEN

2. A sample can be delayed until:
  - a specified edge of an input signal
  - a specified time elapses
  - a specified number of events occur

The text on the Function menu screen that describes the arming mode setup is partitioned so it highlights the separate specification of when to start the block of measurements (Block Holdoff) and when to collect the measurement samples (Sample Arm). This is shown in *Figure 2-4*. For more on all aspects of arming, refer to "Arming," chapter 5.

Figure 2-4.  
Arming Mode Text  
and Explanation

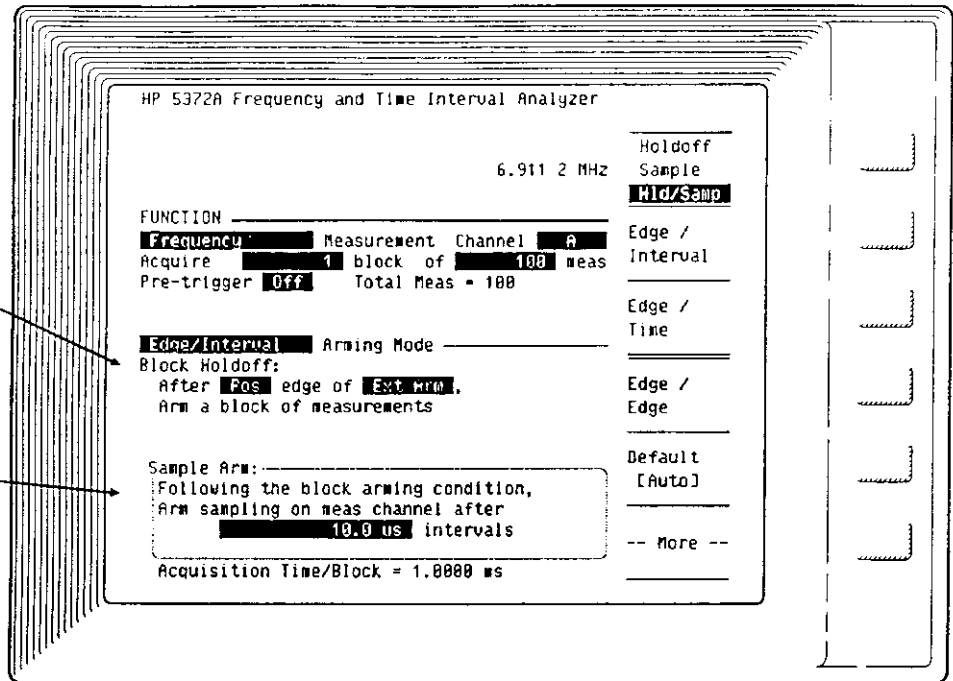

Before a block of measurements can begin, a rising edge on Ext.Arm must occur.

After the Block Holdoff, a sample (time and events) will be taken every 10 μs.

## Frequency Resolution

The resolution of your frequency results is determined by the input frequency and the interval between samples. The longer the sampling interval, the higher the resolution of the results. Figure 2-5 shows the single-shot resolution of the HP 5372A as a function of sampling interval and input frequency.

Figure 2-5.  
Frequency Resolution

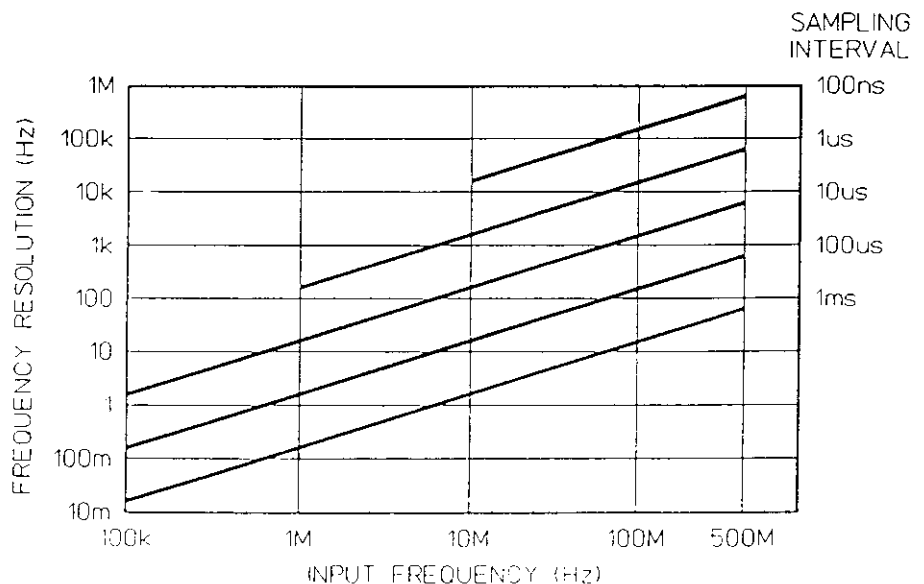

For example, taking samples at 100  $\mu$ s intervals on a 10 MHz input signal will yield a result resolved to 10 Hz (10.00000 MHz).

## FREQUENCY RANGE

The frequency range of the HP 5372A is:

### Normal Measurement Mode

(See description under Sampling Interval)

- 0.125 Hz to 500 MHz on Channel A or B
- 0.250 Hz to 500 MHz on Channel A and B simultaneously
- 100 MHz to 2 GHz on Channel C (optional)

### Fast Measurement Mode

- 8 kHz to 500 MHz on Channel A or B
- 16 kHz to 500 MHz on Channel A and B simultaneously
- 100 MHz to 2 GHz on Channel C (optional)

## PERIOD RANGE

The range of period for the HP 5372A is:

### Normal Measurement Mode

(See description under Sampling Interval)

- 2 ns to 8.0 s on Channel A or B
- 2 ns to 4.0 s on Channel A and B simultaneously
- 500 ps to 10 ns on Channel C (optional)

### Fast Measurement Mode

- 2 ns to 131  $\mu$ s on Channel A or B
- 2 ns to 65  $\mu$ s on Channel A and B simultaneously
- 500 ps to 10 ns on Channel C (optional)

**NOTE**

---

*When using the Fast Mode, the minimum frequency that can be measured is 8 kHz. The maximum time that can be measured, and therefore the maximum time that may elapse between samples is 131 μs. The restriction on elapsed time is applicable regardless of the reason the sampling interval approaches the specified limits. It is therefore important to consider this restriction when setting up arming and when planning to inhibit a measurement sequence for intervals approaching 131 μs. For more on the Inhibit feature, refer to "Pre-trigger Menu," chapter 10.*

---

**FREQUENCY AND PERIOD MEASUREMENTS DESCRIBED**

There is no difference in how the time and event data is collected for frequency and period measurements. The difference is in how the measurement results are computed for the two measurement types.

Frequency results are calculated by dividing the number of trigger events by the time over which those trigger events were counted. Period is just the reverse with the results calculated by dividing the time of the measurement by the number of trigger events.

An example of a frequency and period calculation:

$$\begin{aligned} \text{Frequency} &= \Delta \text{ Event Count} / \Delta \text{ Time Count} \\ &100 \text{ Events} / 10 \mu\text{s} = 10 \text{ MHz} \end{aligned}$$

$$\begin{aligned} \text{Period} &= \Delta \text{ Time Count} / \Delta \text{ Event Count} \\ &10 \mu\text{s} / 100 \text{ Events} = 100 \text{ ns} \end{aligned}$$

**FREQUENCY AND PERIOD CHANNEL CHOICES**

The HP 5372A offers the same channel choices for both frequency and period measurements. The maximum number of measurements per block is 8,191 for all single-channel choices. Two-channel configurations (A & B, A - C, B / A, etc.) are limited to a measurement size of 4,095.



**Single-Channel**

A frequency or period measurement can be made on any of the input channels. The menu choices are:

- A
- B
- C (optional)

**Two-Channel**

A frequency or period measurement can be made on two input channels simultaneously.

**TWO-RESULT  
MEASUREMENT**

- A & B
- A & C (optional)
- B & C (optional)

**Two-Result Measurement Features:**

- Full accuracy is provided for each of the measurement channels.
- Measurement and time of measurement data can be displayed for both channels on the Numeric screen. (Use Numeric screen, Main menu, Expanded Data On)
- Histogram and Time Variation graphs can be viewed individually for each of the two measurement channels. (Use Graphic screen, Display menu, View Channel)
- Statistics can be calculated on both measurement channels. (Use Math menu, Stats On)

**RATIO MEASUREMENT**

The ratio of two input signals can be displayed. The menu choices are:

- A / B
- A / C (optional)
- B / A
- B / C (optional)
- C / A (optional)
- C / B (optional)

The ratio is calculated by taking the result of the "first" channel and dividing it by the result of the "second" channel. For example, the result of "B / A" will be the Channel B result divided by the Channel A result. The Analyzer can display ratios of less than 1.

**SUM MEASUREMENT** The sum of two frequency or period measurements can be displayed. The menu choices are:

- A + B
- A + C (optional)
- B + C (optional)

The two results are added together.

**DIFFERENCE MEASUREMENT** The Analyzer can display the difference of two frequency or period measurements. The menu choices are:

- A - B
- A - C (optional)
- B - A
- B - C (optional)
- C - A (optional)
- C - B (optional)

The result at the "second" channel is subtracted from the "first" channel.

---

**NOTE**

*For Two-Channel Measurements:*

- *Both signals must be present at the input channels before the Analyzer will begin a measurement.*
  - *The number of measurements per block cannot exceed 4,095.*
  - *The measurement rate is set by the signal with the longer period. For example, imagine you are measuring the frequency of two signals. The frequency of one is 10 MHz and the other is 1 Hz. With the arming set to Automatic, which will have the Analyzer sample as fast as possible, it is the 1 Hz signal that sets the sample rate. There will be a measurement on each of the measurement channels approximately once every second.*
  - *All two-channel measurements will sample the first channel before sampling the second channel. For example, when making a B/A measurement, sampling of Channel A is first, even if Channel B events come before events on Channel A.*
-

# FREQUENCY AND PERIOD ARMING MODES

Shown below are the measurement channels and arming modes available for frequency and period measurements.

## HP 5372A Function and Arming Summary

ARMING MODE	MEASUREMENT FUNCTION													
	TIME INTERVAL OR HISTOGRAM TI		CONTINUOUS TIME INTERVAL OR HISTOGRAM CTI		± TIME INTERVAL OR HISTOGRAM ± TI		FREQUENCY, PERIOD		TOTALIZE		POS WIDTH NEG WIDTH RISE TIME FALL TIME DUTY CYCLE	PHASE	PEAK AMPLITUDE	PHASE DEVIATION
A	A→B	A	A	A→B	A	DUAL <sup>1</sup>	A	DUAL <sup>1</sup>	A	A rel B				
B	B→A	B	B	B→A	B	RATIO <sup>2</sup>	B	RATIO <sup>2</sup>	B	B rel A	B	B	B	
						C	SUM <sup>3</sup>	SUM <sup>3</sup>						
							DIFF <sup>4</sup>	DIFF <sup>4</sup>						
AUTOMATIC														
AUTOMATIC	C*	C*	C*		C*	C*	C*			C*	C*	N*	C*	C*
HOLDOFF														
EDGE HOLDOFF	C	C	C		C	C					C		C	C
TIME HOLDOFF	C	C	C			C								
EVENT HOLDOFF	C	C	C			C								
SAMPLING														
INTERVAL SAMPLING	C	C	C		C	C	C	C*	C*		C		C	C
TIME SAMPLING						N								
CYCLE SAMPLING						C								
EDGE SAMPLING						C	C	C	C					
PARITY SAMPLING					C									
REPET EDGE SAMPLING	C	C	C		C									
REPET EDGE-PARITY SAMPLING					C									
RANDOM SAMPLING	C	C			C									
HOLDOFF/SAMPLING														
EDGE/INTERVAL	C	C	C		C	C	C	C	C		C		C	C
EDGE/TIME						N								
EDGE/EDGE						C		C	C					
EDGE/CYCLE						C								
EDGE/EVENT					N	N	N							
EDGE/PARITY					C									
EDGE/RANDOM	C	C			C									
TIME/INTERVAL						C		C						
TIME/TIME					N	N	N							
EVENT/INTERVAL						C								
EVENT/EVENT					N*	N	N							
EXTERNALLY GATED						C		C	C					
MANUAL								N	N					

Symbol C or N indicates that a measurement can be made using the corresponding combination of Function, Channel, and Arming selections.

C = Continuous Arming, (Block/Sample Arming)

N = Non-Continuous arming, (Start/Stop Arming), setups are limited to M blocks of 1 measurement.

1. DUAL. Simultaneous Dual-channel, (2 results). Frequency and Period options are: A&B, A&C, B&C. Totalize option is: A&B.

2. RATIO. Frequency and Period ratio options are: A/B, A/C, B/A, B/C, C/A, C/B. Totalize ratio options are: A/B, B/A.

3. SUM. Frequency and Period sum options are: A+B, A+C, B+C. Totalize sum option is: A+B.

4. DIFFERENCE. Frequency and Period difference options are: A-B, A-C, B-A, B-C, C-A, C-B. Totalize difference options are: A-B, B-A.

\* = Default Arming

## Measurements Referenced To The Block Arming Edge

There are eight arming modes for frequency and period measurements that reference all measurements of a block to the block holdoff arming edge. They are:

- Edge Holdoff
- Time Holdoff
- Event Holdoff
- Edge / Interval
- Edge / Edge
- Edge / Cycle
- Time / Interval
- Event / Interval

For these arming modes, the edge which arms each block is "time-stamped," and the elapsed time between the block arming edge and the first measurement sample is measured.

While all the arming modes provide the time from the beginning of the first measurement of a block, these time-stamp arming modes also provide the time between the block arming edge and the first measurement sample that is collected. The time value is displayed on the Numeric screen. It is listed before the first measurement result of the block and has a "T" in front of it. The diagrams in the next part of this chapter show the time-stamp arming modes with a portion of the example signal labeled with a "T".

### NOTE

---

*To receive valid data, the interval between the block arming edge and the first measurement sample must be within the measurable range of the selected measurement mode:*

*Normal Measurement Mode = 10 ns to 8.0 s*

*Fast Measurement Mode = 10 ns to 131  $\mu$ s*

---

---

TECHNICAL COMMENT



*The HP 5372A has been optimized to always capture both the block arming edge and the first measurement sample, even if they occur only 10 ns apart.*

*If the first measurement sample is received by the HP 5372A less than 100 ns (75 ns for Fast mode) after the block arming edge, the measurement sample will be captured, but the instrument will be storing data during the 180 ns which follow the arming edge. During that 180 ns, trigger events of the measurement signal will be counted but will have no time data associated with them.*

---

**Averaged Results for  
Frequency/Period  
Measurements**

The feature of time-stamping the arming edge makes it possible for the HP 5372A to average multiple blocks of measurements. When you select one of the eight arming modes from the previous page for a multiple-block, single-channel frequency or period measurement, a field on the Function menu will allow selection of "Averaged Results" (the other option is "All Results"). The averaged results are shown on the Numeric screen and the Time Variation graph. If the total number of measurements selected exceeds the size of internal memory, "Averaged Results" is the only option available.

**FREQUENCY AND  
PERIOD ARMING  
MODE EXAMPLES**

Shown on the following pages are the arming modes available for frequency and period measurements along with a timing diagram to illustrate each arming mode. Frequency measurements are used for all the examples, but period measurements operate identically. The difference between the two measurement types is in how the data is processed after the measurement. For these examples, the trigger event is always on the positive slope.

### FREQUENCY MEASUREMENT WITH AUTOMATIC ARMING

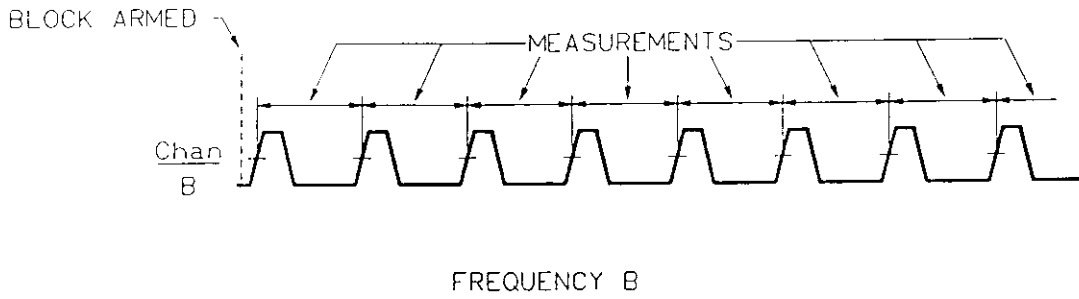

VF56\_N3

Figure 2-6. Frequency | Automatic

#### DESCRIPTION OF DIAGRAM:

- A block of measurements can begin as soon as the Analyzer is ready. The block is armed when the Analyzer is ready to begin measuring.
- Samples are then collected as quickly as possible at the trigger events of Channel B. Seven measurements are shown.

## FREQUENCY MEASUREMENT WITH EDGE HOLDOFF ARMING

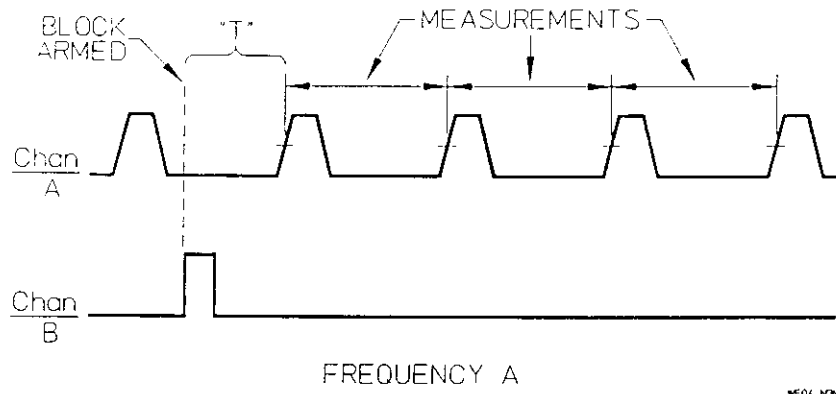

Figure 2-7. Frequency | Edge Holdoff

### DESCRIPTION OF DIAGRAM:

- A block of measurements can begin after a positive edge on Channel B. The block is armed when the block holdoff edge occurs.
- Samples are then collected as quickly as possible at the trigger events of Channel A. Three measurements are shown.
- The diagram shows an edge holdoff of a positive edge on Channel B. Other options are a positive or negative edge on Channel A or External Arm.
- The reference edge is time stamped, so all measurements in the block are referenced in time to the holdoff edge. Averaging of multiple blocks is supported. ("T" on the waveform shows the time measured.)

### FREQUENCY MEASUREMENT WITH TIME HOLDOFF ARMING

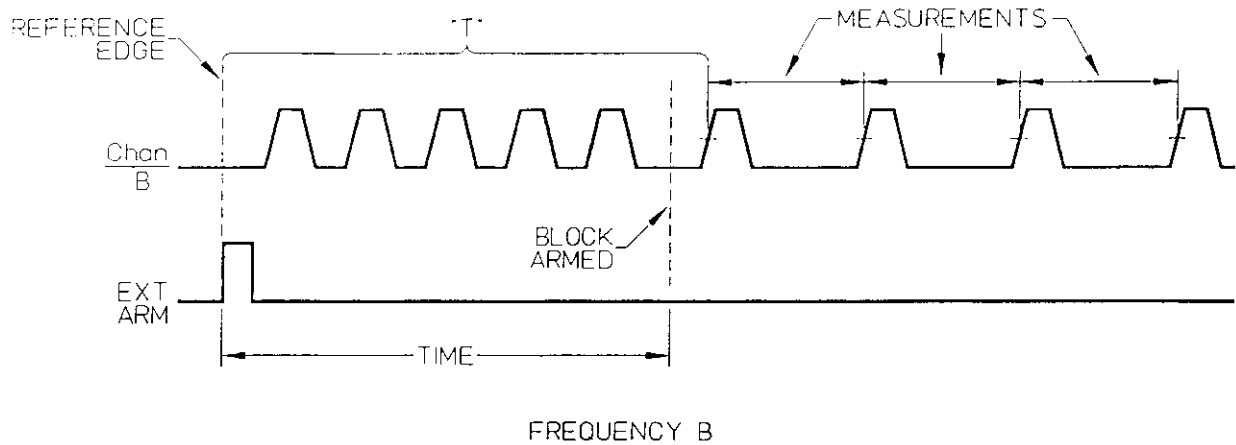

Figure 2-8. Frequency | Time Holdoff

#### DESCRIPTION OF DIAGRAM:

- A block of measurements can begin after a selectable time delay. The start of the time delay is referenced to a positive edge on External Arm. The block is armed when the specified time elapses.
- Samples are then collected as quickly as possible at the trigger events of Channel B. Three measurements are shown.
- The diagram shows the time delay referenced to a positive edge on External Arm. Other options are a positive or negative edge on Channel A or B.
- The reference edge is time stamped, so all measurements in the block are referenced in time to the holdoff edge. Averaging of multiple blocks is supported. ("T" on the waveform shows the time measured.)
- For Normal Measurement Mode:  
Range of Time = 2 ns to 8.0 s. Can be set with a resolution of 2 ns.
- For Fast Measurement Mode:  
Range of Time = 2 ns to 131  $\mu$ s. Can be set with a resolution of 2 ns.



## FREQUENCY MEASUREMENT WITH EVENT HOLDOFF ARMING

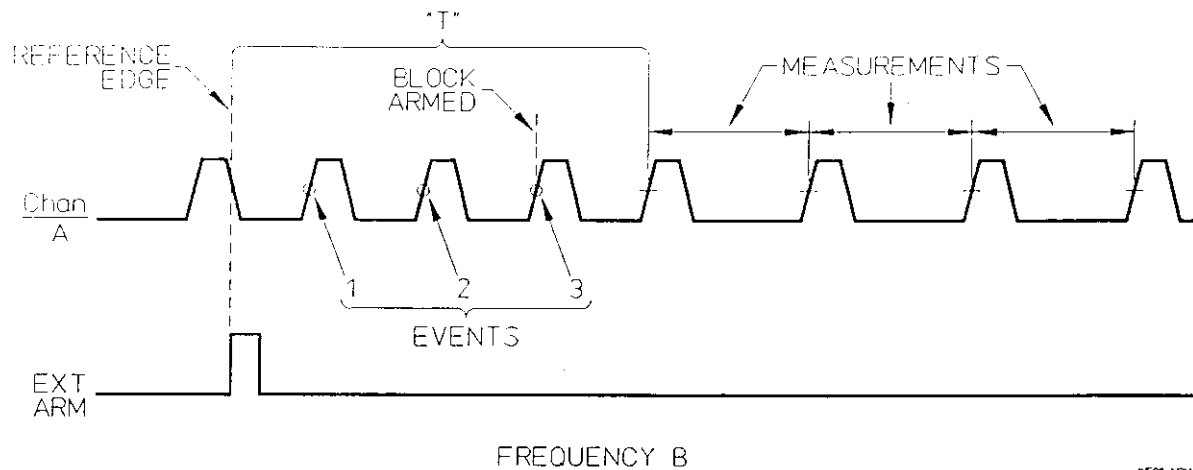
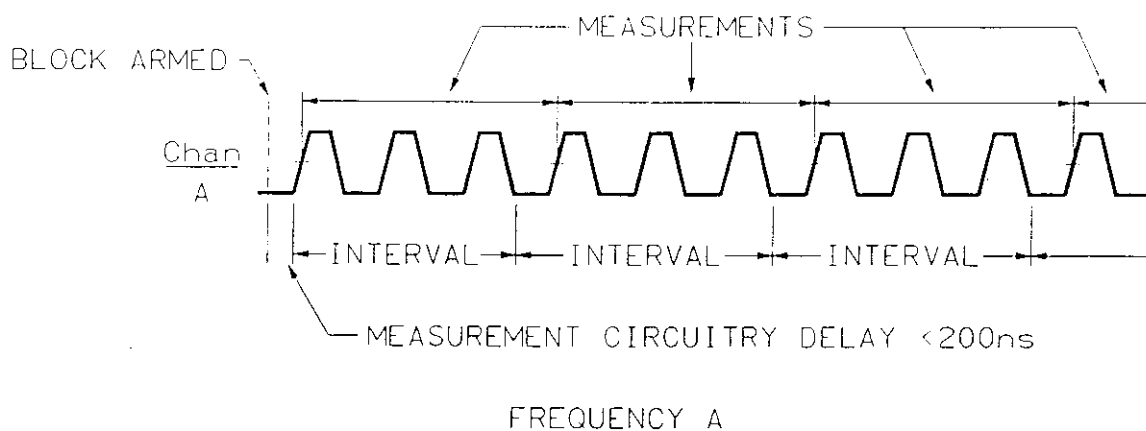

Figure 2-9. Frequency | Event Holdoff

### DESCRIPTION OF DIAGRAM:

- A block of measurements can begin after a selectable event delay. The start of the event delay is referenced to a positive edge on External Arm. The block is armed after the specified number of events (edges) occur on Channel A.
- Samples are then collected as quickly as possible at the trigger events of Channel A. Three measurements are shown.
- The diagram shows an event delay referenced to a positive edge on External Arm. Other options for the reference edge include a positive or negative edge on Channel A or B.
- The delay events can be counted on Channel A or B.
- The reference edge is time stamped, so all measurements in the block are referenced in time to the holdoff edge. Averaging of multiple blocks is supported. ("T" on the waveform shows the time measured.)
- For Normal Measurement Mode:  
Range of Events = 0 to 4,000,000,000
- For Fast Measurement Mode:  
Range of Events = 0 to 65,000

### FREQUENCY MEASUREMENT WITH INTERVAL SAMPLING ARMING



WF42\_N3

Figure 2-10. Frequency | Interval Sampling

#### DESCRIPTION OF DIAGRAM:

- A block of measurements can begin as soon as the Analyzer is ready. The block is armed when the Analyzer is ready to begin measuring.
- A sample is then collected at the trigger event of Channel A after each specified sample interval. The first sample is taken at the trigger event after the start of the first interval. Measurements end at the trigger event following each interval. The sample interval is repetitive and asynchronous with the signal being measured. Three measurements are shown.
- For Normal Measurement Mode:  
Range of Interval = 100 ns to 8.0 s. Can be set with a resolution of 100 ns.
- For Fast Measurement Mode:  
Range of Interval = 100 ns to 131  $\mu$ s. Can be set with a resolution of 100 ns.

## FREQUENCY MEASUREMENT WITH TIME SAMPLING ARMING

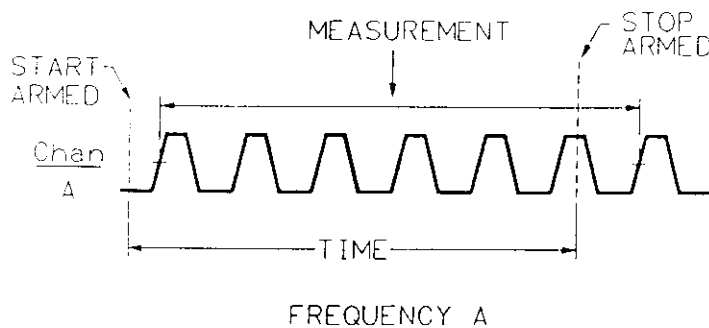

Figure 2-11. Frequency | Time Sampling

### DESCRIPTION OF DIAGRAM:

- Measurement can begin as soon as the Analyzer is ready. The measurement start is armed when the Analyzer is ready to begin measuring.
- Measurement starts at the trigger event of Channel A following the Start Arm.
- Measurement ends at the trigger event following the end of the Stop Arm time delay. The time delay is referenced to the Start Arm.
- The maximum number of measurements per block is 1. Configurations such as 100 blocks of 1 measurement are allowed.
- For Normal Measurement Mode:  
Range of Time = 2 ns to 8.0 s. Can be set with a resolution of 2 ns.
- For Fast Measurement Mode:  
Range of Time = 2 ns to 131  $\mu$ s. Can be set with a resolution of 2 ns.

### FREQUENCY MEASUREMENT WITH CYCLE SAMPLING ARMING

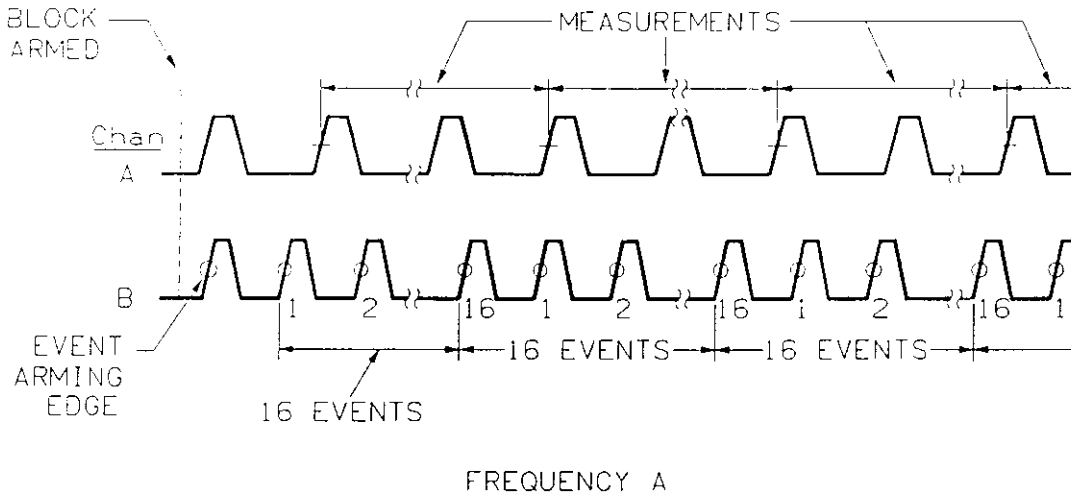

Figure 2-12. Frequency | Cycle Sampling

#### DESCRIPTION OF DIAGRAM:

- A block of measurements can begin as soon as the Analyzer is ready. The block is armed when the Analyzer is ready to begin measuring.
- A trigger event on Channel B arms the start of the counting of cycles on Channel B.
- Samples are collected at the trigger event of Channel A after each specified cycle interval. The first sample is taken on the trigger event on Channel A following the event arming edge. Measurements end at the trigger event after each cycle interval. Three measurements are shown.
- The diagram shows cycles being counted on positive edges of Channel B. Other options are negative or positive edges of Channel A, or the 2 ns internal timebase. The slope for Channel A and B edges is set on the Input menu Slope field.

## ■ For Normal Measurement Mode:

Cycles	Minimum Frequency on Arming Channel
$2^4$	2 Hz
$2^8$	32 Hz
$2^{12}$	512 Hz
$2^{16}$	8.192 kHz
$2^{20}$	131.072 kHz
$2^{24}$	2.097152 MHz
$2^{28}$	33.554432 MHz

## ■ For Fast Measurement Mode:

Cycles	Minimum Frequency on Arming Channel
$2^4$	122.137 kHz
$2^8$	1.954198 MHz
$2^{12}$	31.267175 MHz

**NOTE**

*If you set up cycle arming such that the channel arming the samples is the same as the channel being measured, you must be careful not to violate the conditions below.*

*Elapsed events between samples must not exceed:*

*$(2^{32} - 2)$  in Normal Measurement Mode*

*$(2^{16} - 2)$  in Fast Measurement Mode*

### FREQUENCY MEASUREMENT WITH EDGE SAMPLING ARMING

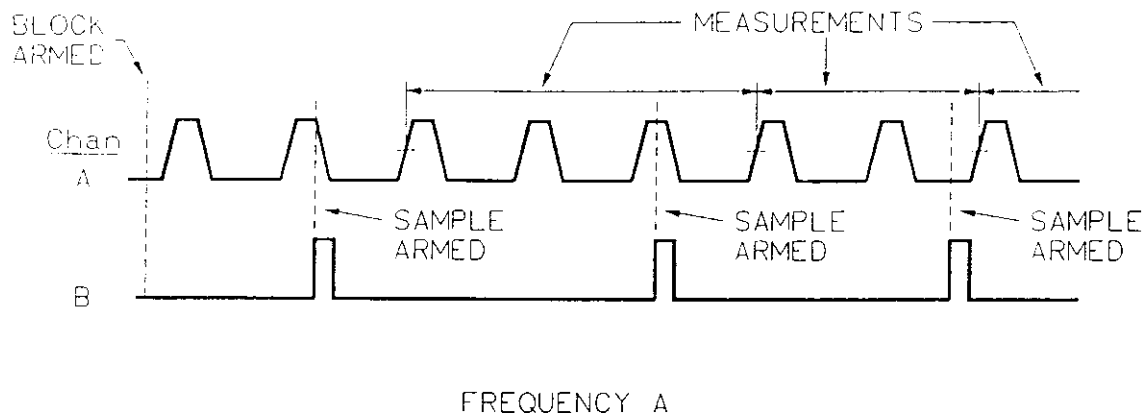

WF45\_N3

Figure 2-13. Frequency | Edge Sampling

#### DESCRIPTION OF DIAGRAM:

- A block of measurements can begin as soon as the Analyzer is ready. The block is armed when the Analyzer is ready to begin measuring.
- Samples are armed after a positive edge on Channel B. One sample is collected per arming edge. An edge is required before each sample. Two measurements are shown.
- The diagram shows a positive edge on Channel B arming each sample. Other options for the arming edge are a positive or negative edge on Channel A or External Arm.
- For Normal Measurement Mode:

**NOTE** \_\_\_\_\_

*The period of the sample arm signal should not exceed 8.0 s.*

- For Fast Measurement Mode:

**NOTE** \_\_\_\_\_

*The period of the sample arm signal should not exceed 131  $\mu$ s.*

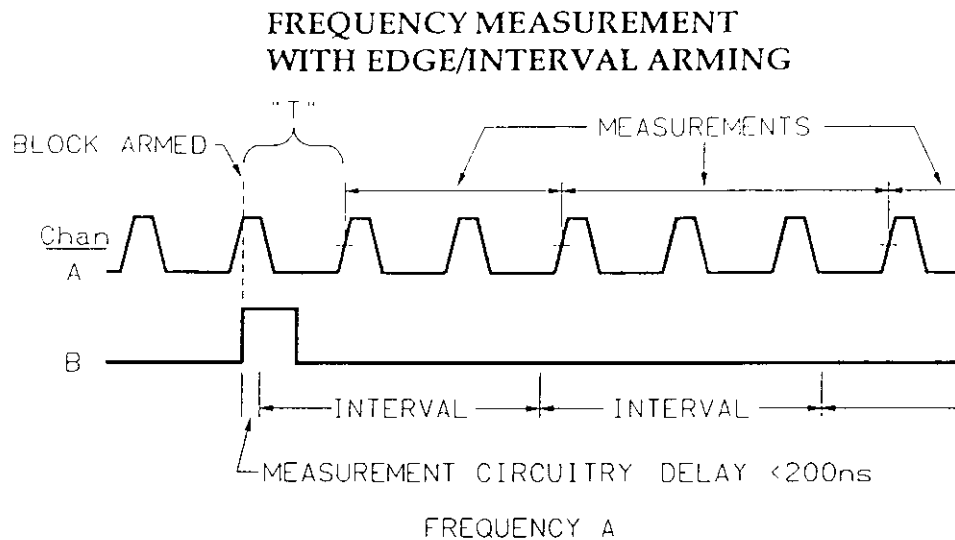

Figure 2-14. Frequency | Edge/Interval

**DESCRIPTION OF DIAGRAM:**

- A block of measurements can begin after a positive edge on Channel B. The block is armed when the edge occurs on Channel B.
- Samples are then collected at the trigger event of Channel A after each interval. The first sample is taken at the trigger event after the start of the first interval. Measurements end at the trigger event following each interval. The sample interval is repetitive and asynchronous with the signal being measured. Two measurements are shown.
- The diagram shows an edge holdoff of a positive edge on Channel B. Other options are a positive or negative edge on Channel A or External Arm.
- The reference edge is time stamped, so all measurements in the block are referenced in time to the holdoff edge. Averaging of multiple blocks is supported. ("T" on the waveform shows the time measured.)
- For Normal Measurement Mode:
 

Range of Interval = 100 ns to 8.0 s. Can be set with a resolution of 100 ns.
- For Fast Measurement Mode:
 

Range of Interval = 100 ns to 131  $\mu$ s. Can be set with a resolution of 100 ns.

### FREQUENCY MEASUREMENT WITH EDGE/TIME ARMING

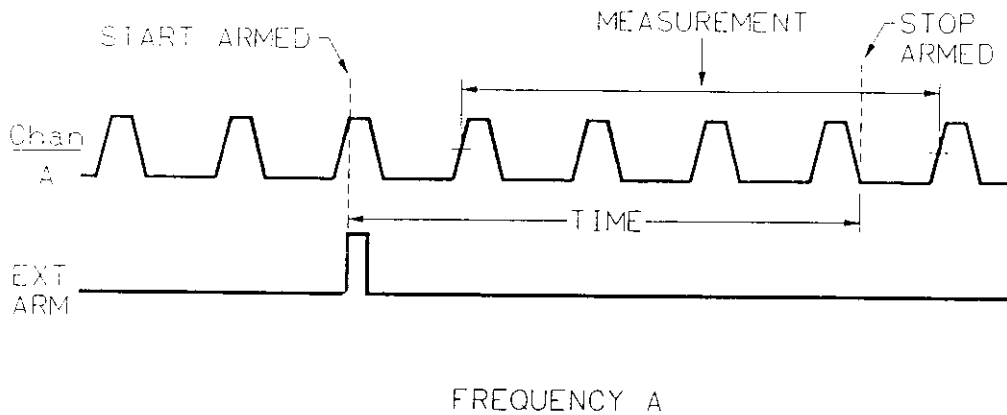

WF47\_N3

Figure 2-15. Frequency | Edge/Time

#### DESCRIPTION OF DIAGRAM:

- Measurement can begin after a positive edge on External Arm. The measurement start is armed when the Start Arm edge occurs on External Arm.
- Measurement starts at the trigger event of Channel A following the Start Arm edge.
- Measurement ends at the trigger event following the end of the Stop Arm time delay. The Stop Arm time delay is referenced to the Start Arm edge.
- The diagram shows an edge holdoff of a positive edge on External Arm. Other options are a positive or negative edge on Channel A or B.
- The maximum number of measurements per block is 1. Configurations such as 100 blocks of 1 are allowed.
- For Normal Measurement Mode:
  - Range of Time = 2 ns to 8.0 s. Can be set with a resolution of 2 ns.
- For Fast Measurement Mode:
  - Range of Time = 2 ns to 131  $\mu$ s. Can be set with a resolution of 2 ns.



## FREQUENCY MEASUREMENT WITH EDGE/EDGE ARMING

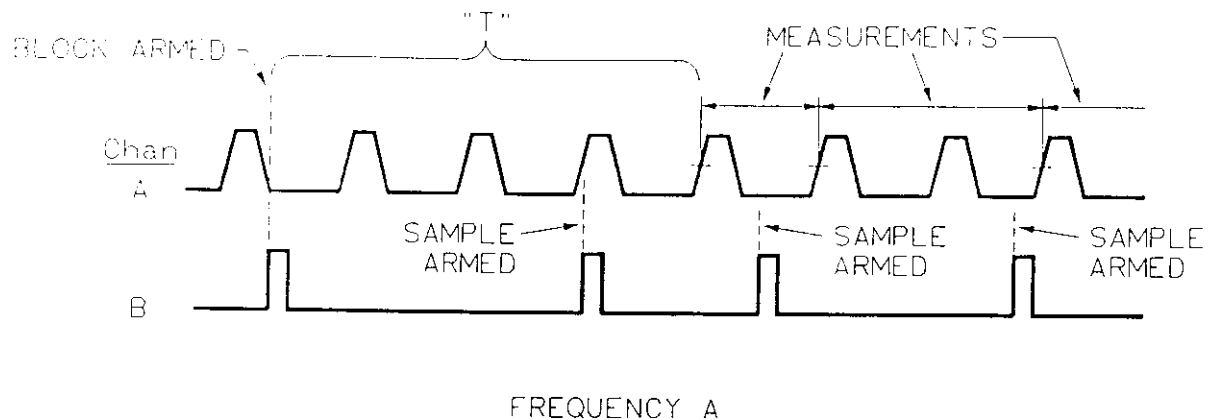

WF48\_N3

Figure 2-16. Frequency | Edge/Edge

### DESCRIPTION OF DIAGRAM:

- A block of measurements can begin after a positive edge on Channel B. The block is armed when the block holdoff edge occurs.
- A sample is then collected after a positive edge on Channel B. One sample is collected per arming edge. An edge is required before each sample. Two measurements are shown.
- The diagram shows an edge holdoff and a sample edge of a positive edge on Channel B. Other options are a positive or negative edge on Channel A or External Arm.
- The block holdoff reference edge is time stamped, so all measurements in the block are referenced in time to the holdoff edge. Averaging of multiple blocks is supported. ("T" on the waveform shows the time measured.)

## FREQUENCY MEASUREMENT WITH EDGE/CYCLE ARMING

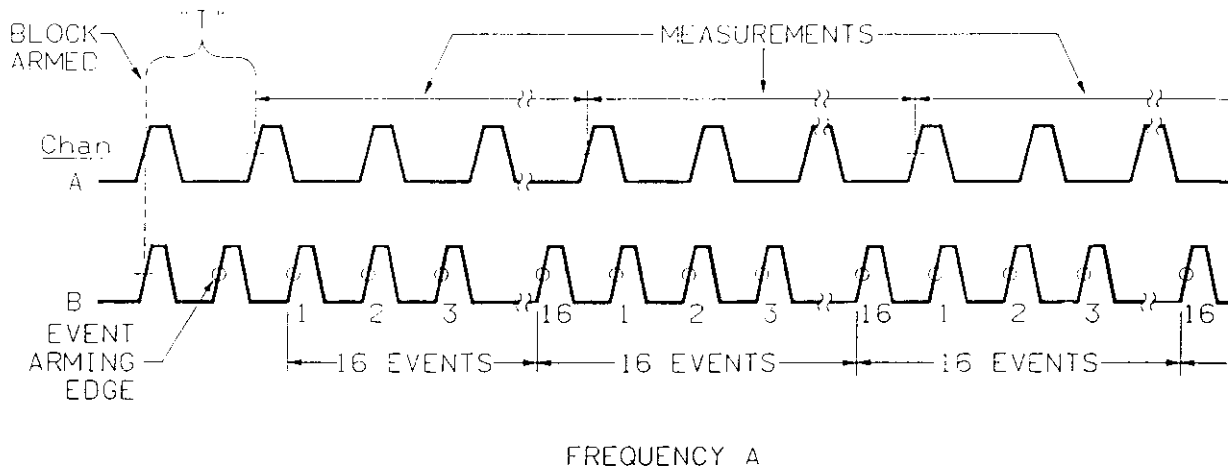

WF50\_N3

Figure 2-17. Frequency | Edge/Cycle

### DESCRIPTION OF DIAGRAM:

- A block of measurements is armed after a positive edge on Channel B.
- A trigger event on Channel B arms the start of the counting of cycles on Channel B.
- Samples are then taken on the trigger event of Channel A after each specified cycle interval. The first sample is taken on the trigger event of Channel A after the arming edge. The measurements end on the trigger event following each cycle interval. Two measurements are shown.
- The diagram shows an edge holdoff of a positive edge on Channel B. Other options are a positive or negative edge on Channel A or External Arm.
- The diagram shows cycles being counted on positive edges of Channel B. Other options are negative or positive edges of Channel A, or the 2 ns internal timebase. The slope for Channel A and B is set on the Input menu Slope field.
- The reference edge is time stamped, so all measurements in the block are referenced in time to the holdoff edge. Averaging of multiple blocks is supported. ("T" on the waveform shows the time measured.)

■ For Normal Measurement Mode:

Cycles	Minimum Frequency on Arming Channel
$2^4$	2 Hz
$2^8$	32 Hz
$2^{12}$	512 Hz
$2^{16}$	8.192 kHz
$2^{20}$	131.072 kHz
$2^{24}$	2.097152 MHz
$2^{28}$	33.554432 MHz

■ For Fast Measurement Mode:

Cycles	Minimum Frequency on Arming Channel
$2^4$	122.137 kHz
$2^8$	1.954198 MHz
$2^{12}$	31.267175 MHz

**NOTE**

---

*If you set up cycle arming such that the channel arming the samples is the same as the channel being measured, you must be careful not to violate the conditions below:*

*Elapsed events between samples must not exceed:*

*$(2^{32}-2)$  in Normal Measurement Mode*

*$(2^{16}-2)$  in Fast Measurement Mode*

---

## FREQUENCY MEASUREMENT WITH EDGE/EVENT ARMING

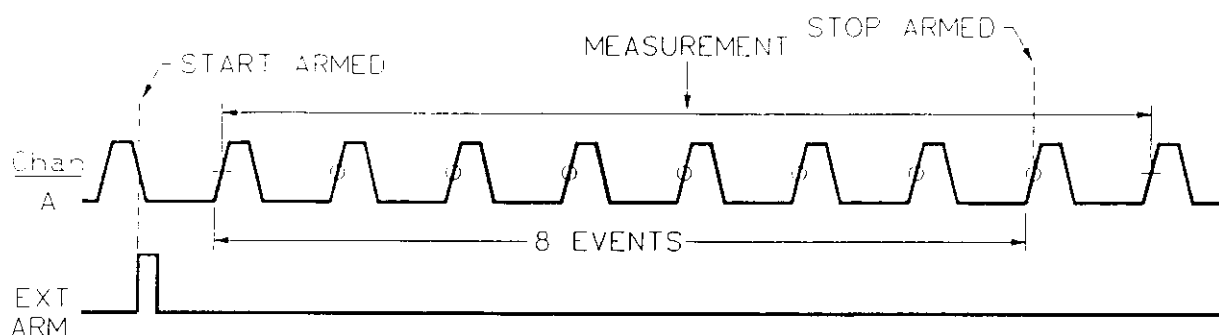

FREQUENCY A

WF51\_N3

Figure 2-18. Frequency | Edge/Event

### DESCRIPTION OF DIAGRAM:

- Measurement can begin after a positive edge on External Arm. The measurement start is armed when the Start Arm edge occurs on External Arm.
- Measurement starts at the trigger event of Channel A following the Start Arm edge.
- The start of the selectable event delay is at the next trigger event on Channel A. (If you are counting and measuring on the same signal, as shown in the diagram, the first counted event is also the start of the measurement.)
- Measurement ends at the trigger event following the last of the Stop Arm events. The Stop Arm delay is eight events on Channel A.
- The diagram shows the Start Arm edge as a positive edge on External Arm. Other options are a positive or negative edge on Channel A or B.
- The delay events can be counted on Channel A or B.

- For Normal Measurement Mode:

Range of Events = 0 to 4,000,000,000

**NOTE** \_\_\_\_\_

*The total period of the Stop Arm events must not exceed 8.0 s.*

---

- For Fast Measurement Mode:

Range of Events = 0 to 65,000

**NOTE** \_\_\_\_\_

*The total period of the Stop Arm events must not exceed 131  $\mu$ s.*

---

### FREQUENCY MEASUREMENT WITH TIME/INTERVAL ARMING

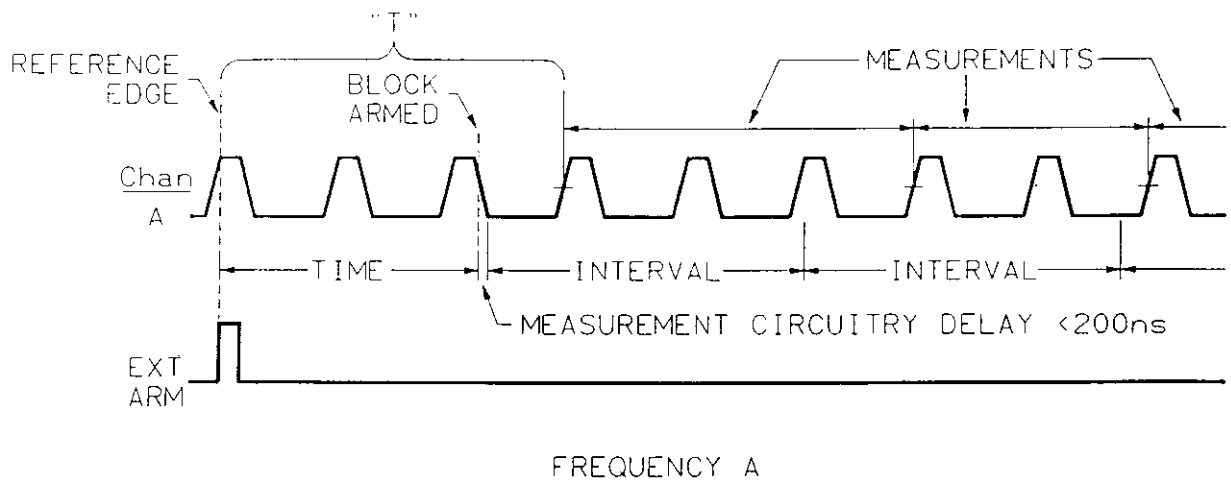

Figure 2-19. Frequency | Time/Interval

#### DESCRIPTION OF DIAGRAM:

- A block of measurements can begin after a selectable time delay. The start of the time delay is referenced to a positive edge on External Arm.
- Samples are collected at the trigger event of Channel A after each interval. The first sample is taken at the trigger event after the start of the first interval. Measurements end at the trigger event following each interval. The sample interval is repetitive and asynchronous with the signal being measured. Two measurements are shown.
- The diagram shows a time delay referenced to a positive edge on External Arm. Other options are a positive or negative edge on Channel A or B.
- The reference edge is time stamped, so all measurements in the block are referenced in time to the holdoff edge. Averaging of multiple blocks is supported. ("T" on the waveform shows the time measured.)

■ For Normal Measurement Mode:

Range of Time = 2 ns to 8.0 s. Can be set with a resolution of 2 ns.

Range of Interval = 100 ns to 8.0 s. Can be set with a resolution of 100 ns.

■ For Fast Measurement Mode:

Range of Time = 2 ns to 131  $\mu$ s. Can be set with a resolution of 2 ns.

Range of Interval = 100 ns to 131  $\mu$ s. Can be set with a resolution of 100 ns

## FREQUENCY MEASUREMENT WITH TIME/TIME ARMING

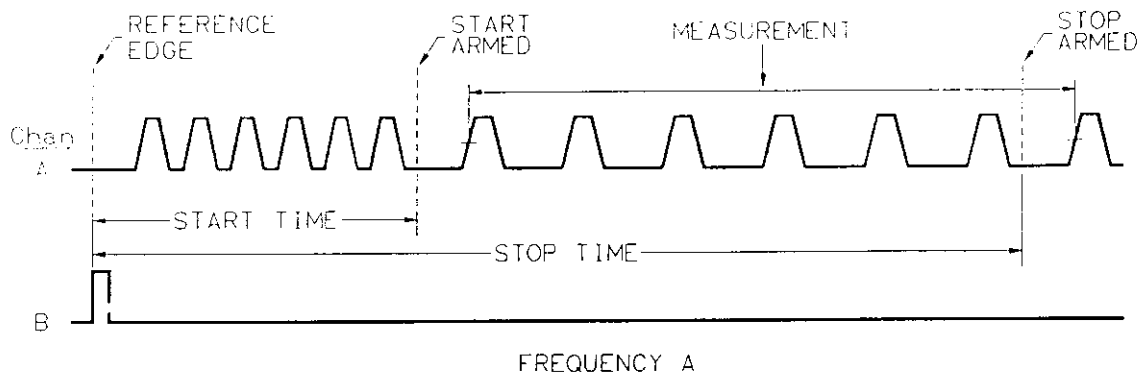

WF53.N3

Figure 2-20. Frequency | Time/Time

### DESCRIPTION OF DIAGRAM:

- Measurement can begin after a selectable time delay. The start of the time delay is referenced to a positive edge on Channel B. The measurement start is armed when the specified time elapses.
- Measurement starts at the trigger event of Channel A, following the end of the Start Arm time delay.
- Measurement ends at the trigger event following the end of the Stop Arm time delay. The Start and Stop Arm time delays are both referenced to the Start Arm reference edge.
- The diagram shows a time delay referenced to a positive edge on Channel B. Other options are a positive or negative edge on Channel A or External Arm.
- The maximum number of measurements per block is 1. Configurations such as 100 blocks of 1 measurement are allowed.



- For Normal Measurement Mode:

Range of Time = 2 ns to 8.0 s. Can be set with a resolution of 2 ns.

- For Fast Measurement Mode:

Range of Time = 2 ns to 131  $\mu$ s. Can be set with a resolution of 2 ns.

**NOTE** \_\_\_\_\_

*The elapsed time between measurement samples should not exceed 4.0 s for Normal measurement mode or 65  $\mu$ s for Fast measurement mode.*

---

### FREQUENCY MEASUREMENT WITH EVENT/INTERVAL ARMING

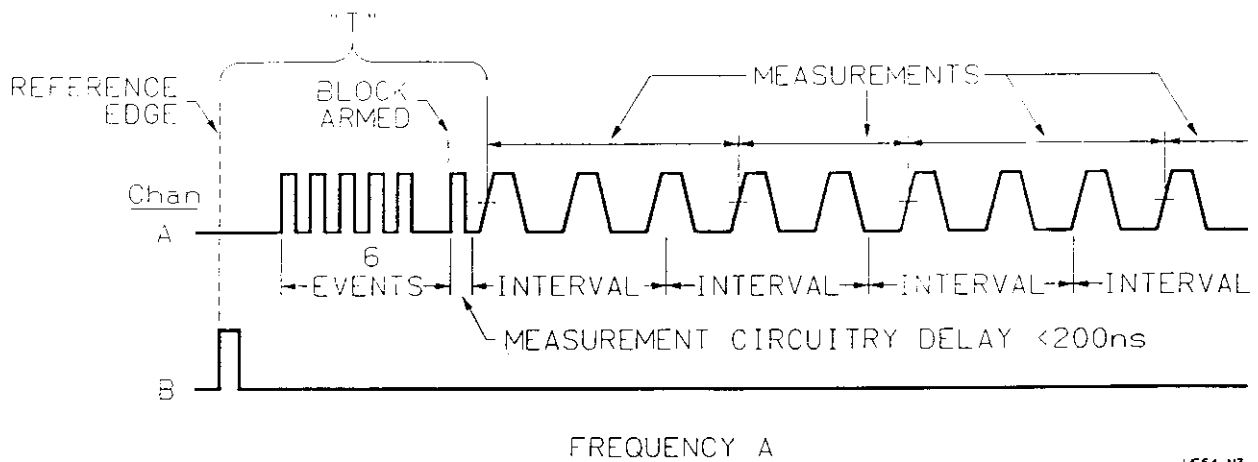

Figure 2-21. Frequency | Event Interval

#### DESCRIPTION OF DIAGRAM:

- A block of measurements can begin after a selectable event delay. The start of the event delay is referenced to a positive edge on Channel B. The block is armed after the specified number of events (edges) occur on the specified input.
- A sample is collected at the trigger event of Channel A after each interval. The first sample is taken at the trigger event after the start of the first interval. Measurements end on the trigger event following each interval. The sample interval is repetitive and asynchronous with the signal being measured. Three measurements are shown.
- The diagram shows an event delay referenced to a positive edge on Channel B. Other options are a positive or negative edge on Channel A or External Arm.
- The reference edge is time stamped, so all measurements in the block are referenced in time to the holdoff edge. Averaging of multiple blocks is supported. ("T" on the waveform shows the time measured.)

- For Normal Measurement Mode:

Range of Events = 0 to 4,000,000,000

Range of Interval = 100 ns to 8.0 s. Can be set with a resolution of 100 ns.

- For Fast Measurement Mode:

Range of Events = 0 to 65,000

Range of Interval = 100 ns to 131  $\mu$ s. Can be set with a resolution of 100 ns.

### FREQUENCY MEASUREMENT WITH EVENT/EVENT ARMING

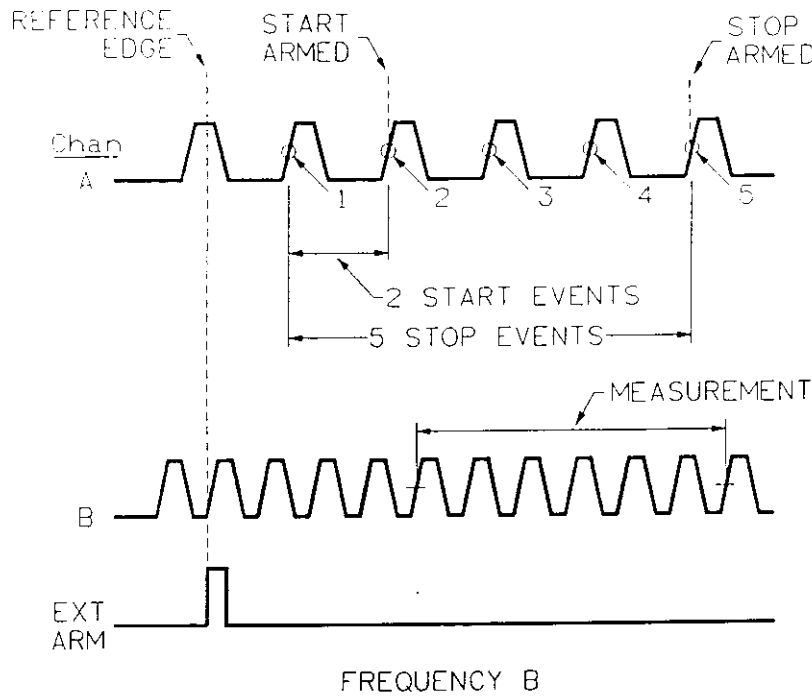

WF55\_N3

Figure 2-22. Frequency | Event/Event

#### DESCRIPTION OF DIAGRAM:

- Measurement can begin after a selectable event delay. The start of the event delay is referenced to a positive edge on External Arm. The measurement start is armed after the specified number of events (edges) occur on Channel A.
- Measurement starts at the trigger event of Channel B, following the Start Arm event count. The start delay is two events.
- Measurement ends at the trigger event following the end of the Stop Arm event count. The stop delay is five events. The start and stop event delays are both referenced to the Start Arm edge.
- The diagram shows an event delay referenced to a positive edge on External Arm. Other options for the reference edge are a positive or negative edge on Channel A or B.
- The delay events can be counted on Channel A or B.

- The maximum number of measurements per block is 1. Configurations such as 100 blocks of 1 measurement are allowed.
- For Normal Measurement Mode:  
Range of Events = 0 to 4,000,000,000
- For Fast Measurement Mode:  
Range of Events = 0 to 65,000

**NOTE**

---

*The elapsed time between samples must fall within the measurable range. It is 10 ns to 4.0 s for Normal measurement mode or 10 ns to 65  $\mu$ s for Fast measurement mode.*

*If the Stop Arm condition is satisfied before the Start Arm condition, the gate time will be positive. The gate time is the absolute value of the stop time - start time.*

---

### FREQUENCY MEASUREMENT WITH EXTERNALLY GATED ARMING

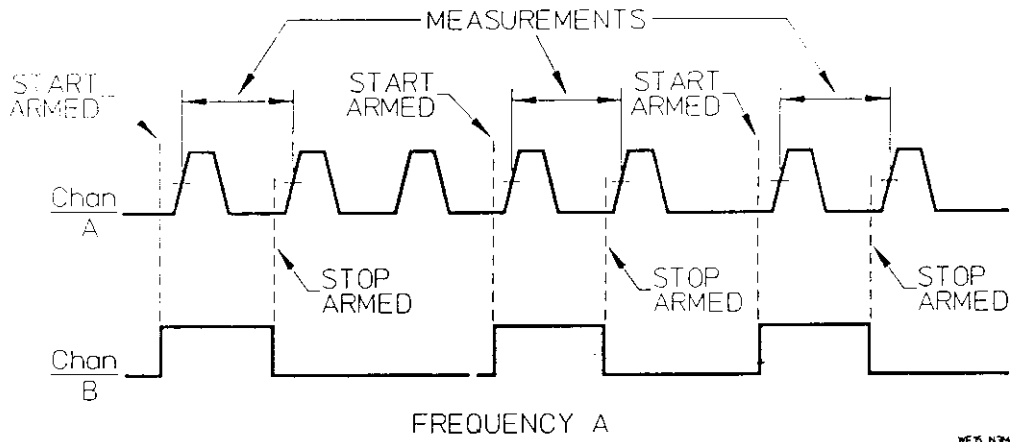

Figure 2-23. Frequency | Externally Gated

#### DESCRIPTION OF DIAGRAM:

- Start of measurement can begin after a positive edge on Channel B.
- Measurement starts at the next trigger event of Channel A.
- Stop of measurement is armed after the opposite edge of the Start Arm signal.
- Measurement stops at the next trigger event of Channel A.
- The diagram shows the Start Arm/Stop Arm signal occurring on Channel B. Other options include a signal on Channel A or External Arm.
- For Normal Measurement Mode:
 

Pulse width of gating channel should be less than 8.0 s. Samples must be separated by an elapsed time less than 8.0 s.
- For Fast Measurement Mode:
 

Pulse width of gating channel should be less than 131  $\mu$ s. Samples must be separated by an elapsed time less than 131  $\mu$ s.

000000

3 SPECIAL PURPOSE  
3 MEASUREMENTS





## Contents of Chapter

---

Chapter Overview .....	3-1
Totalize .....	3-1
Totalize Measurements Described .....	3-2
Totalize Channel Choices .....	3-2
Single-Channel .....	3-3
Two-Channel .....	3-3
Two-result Measurement .....	3-3
Ratio Measurement .....	3-3
Sum Measurement .....	3-4
Difference Measurement .....	3-4
Totalize Arming Modes .....	3-5
Totalize Arming Mode Examples .....	3-6
Totalize Measurement with Interval Sampling Arming .....	3-6
Totalize Measurement with Edge Sampling Arming .....	3-7
Totalize Measurement with Edge/Interval Arming .....	3-8
Totalize Measurement with Edge/Edge Arming .....	3-9
Totalize Measurement with Externally Gated Arming .....	3-10
Totalize Measurement with Time/Interval Arming .....	3-11
Totalize Measurement with Manual Arming .....	3-12
Automatic Measurements .....	3-13
Rise Time .....	3-14
Fall Time .....	3-16
Positive Pulse Width .....	3-18
Negative Pulse Width .....	3-20
Duty Cycle .....	3-22
Phase .....	3-24
Peak Amplitude .....	3-28
Phase and Time Deviation Measurements .....	3-30
Measurements Referenced to the Block Arming Edge .....	3-30
Averaged Results for Phase/Time Deviation Measurements .....	3-31
Phase Deviation .....	3-32
Time Deviation .....	3-36

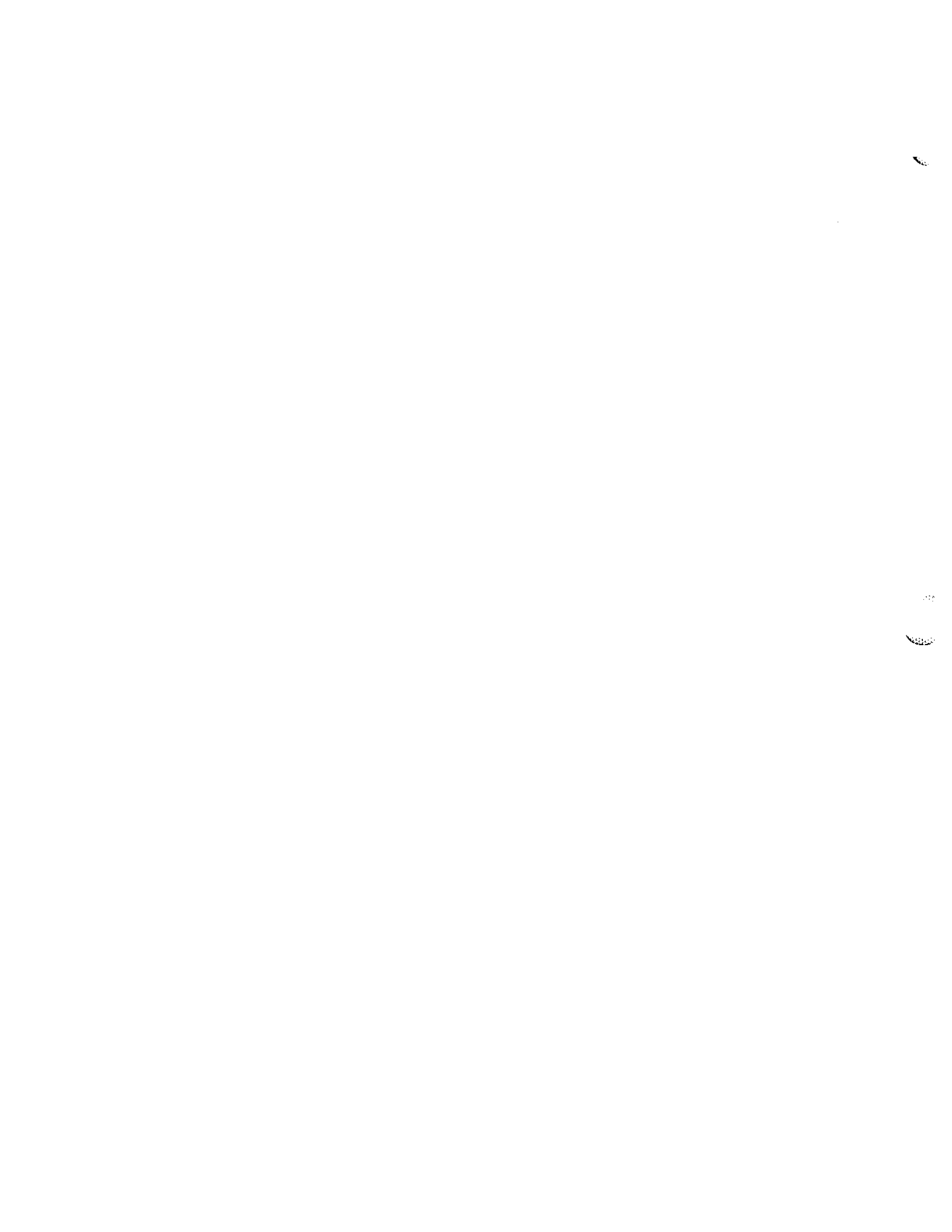

## SPECIAL-PURPOSE MEASUREMENTS

---

### CHAPTER OVERVIEW

Special-Purpose Measurements is a category of HP 5372A functions that includes:

- Totalize
- Rise Time
- Fall Time
- Positive Pulse Width
- Negative Pulse Width
- Duty Cycle
- Phase
- Phase Deviation
- Time Deviation
- Peak Amplitude

These measurement functions are called "Special-Purpose Measurements" because they are more specific in what they can accomplish than are time interval or frequency and period measurements. Details are included in the individual measurement descriptions that follow.

This chapter contains the following:

- A description of each of the measurements.
- The channel options available for each measurement.
- The available arming modes for each measurement.

### TOTALIZE

The Totalize function counts the number of trigger events on the input signal received during a specified period of time, between a pair of designated signal edges, or between presses of the Manual Arm key. The totalize function allows counting of 0 to 4,000,000,000 events on Channel A and B.

### TECHNICAL COMMENT

---

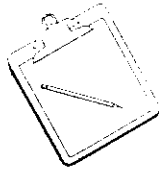

A trigger event is a specific voltage on a rising or falling slope of an input signal that will trigger the HP 5372A to initiate some action. This action can be to arm a measurement, begin a measurement, or end a measurement. Refer to "Input Menu," chapter 8 for more information on how a trigger event is specified.

---

### Totalize Measurements Described

In contrast to the other measurement functions of the HP 5372A, a totalize measurement sample is not necessarily taken at the trigger event of the input signal. (Refer to chapter 2 for a description of a "sample.")

Instead of measurement samples only being taken at the trigger event following an arming event, for totalize measurements, the sampling is synchronous with the arming event.

The arming event can be the end of a specified time interval, a specified edge, or a press of the Manual Arm key (for the Manual arming mode).

A totalize measurement is defined by two consecutive samples. The totalize result is the number of events counted between the two sample points.

### NOTE

---

*Fast Measurement Mode is not supported for Totalize Measurements.*

---

### TOTALIZE CHANNEL CHOICES

The HP 5372A offers the same input channel combinations for totalize as for frequency and period measurements.

The maximum number of measurements per block is 4,095 for all channel choices. The maximum number of measurements allowed (number of blocks  $\times$  number of measurements per block) can equal  $99,999,999 \times 4,095$ .

### Single-Channel

A totalize measurement can be made on the Channel A or B input. The menu choices are:

- A
- B

### Two-Channel

A totalize measurement can be made on two input channels simultaneously.

#### TWO-RESULT MEASUREMENT

- A & B

Two-Result Measurement Features:

- Full accuracy is provided for each of the measurement channels.
- Measurement and time of measurement data can be displayed for both channels on the Numeric screen. (Use Numeric screen, Main menu, Expanded Data On)
- Histogram and Time Variation graphs can be viewed individually for each of the two measurement channels. (Use Graphic screen, Display menu, View Channel)
- Statistics can be calculated on both measurement channels. (Use Math menu, Statistics On)

#### RATIO MEASUREMENT

The ratio of two input signals can be displayed. The menu choices are:

- A / B
- B / A

The ratio is calculated by taking the result of the "first" channel and dividing it by the result of the "second" channel. For example, the result of "B / A" will be the Channel B result divided by the Channel A result. The HP 5372A can display ratios of less than 1.

SUM MEASUREMENT    The sum of two totalize measurements can be displayed. The menu choice is:

- A + B

The two results are added together.

DIFFERENCE MEASUREMENT    The HP 5372A can display the difference of two totalize measurements. The menu choices are:

- A - B
- B - A

The result of the "second" channel is subtracted from the result of the "first" channel.

# TOTALIZE ARMING MODES

Shown below are the arming modes for totalize measurements.

## HP 5372A Function and Arming Summary

ARMING MODE	MEASUREMENT FUNCTION																	
	TIME INTERVAL OR HISTOGRAM TI		CONTINUOUS TIME INTERVAL OR HISTOGRAM CTI	± TIME INTERVAL OR HISTOGRAM ± TI		FREQUENCY, PERIOD		TOTALIZE		POS WIDTH	NEG WIDTH	RISE TIME	FALL TIME	DUTY CYCLE	PHASE	PEAK AMPLITUDE	PHASE DEVIATION	TIME DEVIATION
	A	A→B	A	A	A→B	A	DUAL <sup>1</sup>	A	DUAL <sup>1</sup>	A				A rel B	A	A	A	
	B	B→A	B	B	B→A	B	RATIO <sup>2</sup>	B	RATIO <sup>2</sup>					B rel A	B	B	B	
						C	SUM <sup>3</sup>		SUM <sup>3</sup>									
							DIFF <sup>4</sup>		DIFF <sup>4</sup>									
AUTOMATIC																		
AUTOMATIC	C*	C*	C*		C*	C*	C*			C*	C*			N*	C*	C*	C*	
HOLDOFF																		
EDGE HOLDOFF	C	C	C		C	C								C			C	C
TIME HOLDOFF	C	C	C			C												
EVENT HOLDOFF	C	C	C			C												
SAMPLING																		
INTERVAL SAMPLING	C	C	C		C	C	C	C*	C*					C			C	C
TIME SAMPLING							N											
CYCLE SAMPLING							C											
EDGE SAMPLING							C	C	C	C								
PARITY SAMPLING							C											
REPET EDGE SAMPLING	C	C	C		C													
REPET EDGE-PARITY SAMPLING							C											
RANDOM SAMPLING	C	C			C													
HOLDOFF/SAMPLING																		
EDGE/INTERVAL	C	C	C		C	C	C	C	C					C			C	C
EDGE/TIME							N											
EDGE/EDGE							C		C	C								
EDGE/CYCLE							C											
EDGE/EVENT					N	N	N											
EDGE/PARITY							C											
EDGE/RANDOM	C	C			C													
TIME/INTERVAL							C		C									
TIME/TIME					N	N	N											
EVENT/INTERVAL							C											
EVENT/EVENT					N*	N	N											
EXTERNALLY GATED							C		C	C								
MANUAL									N	N								

Symbol C or N indicates that a measurement can be made using the corresponding combination of Function, Channel, and Arming selections.

C = Continuous Arming (Block/Sample Arming)

N = Non-Continuous arming (Start/Stop Arming), setups are limited to M blocks of 1 measurement.

1. DUAL. Simultaneous Dual-channel, (2 results). Frequency and Period options are: A&B, A&C, B&C. Totalize option is: A&B.

2. RATIO. Frequency and Period ratio options are: A/B, A/C, B/A, B/C, C/A, C/B. Totalize ratio options are: A/B, B/A.

3. SUM. Frequency and Period sum options are: A+B, A+C, B+C. Totalize sum option is: A+B.

4. DIFFERENCE. Frequency and Period difference options are: A-B, A-C, B-A, B-C, C-A, C-B. Totalize difference options are: A-B, B-A.

\* = Default Arming

**TOTALIZE ARMING  
MODE EXAMPLES**

Shown below are the arming modes available for totalize measurements along with a timing diagram to illustrate each arming mode. For these examples, the trigger event is always on the positive slope of the input signals.

**TOTALIZE MEASUREMENT WITH  
INTERVAL SAMPLING ARMING**

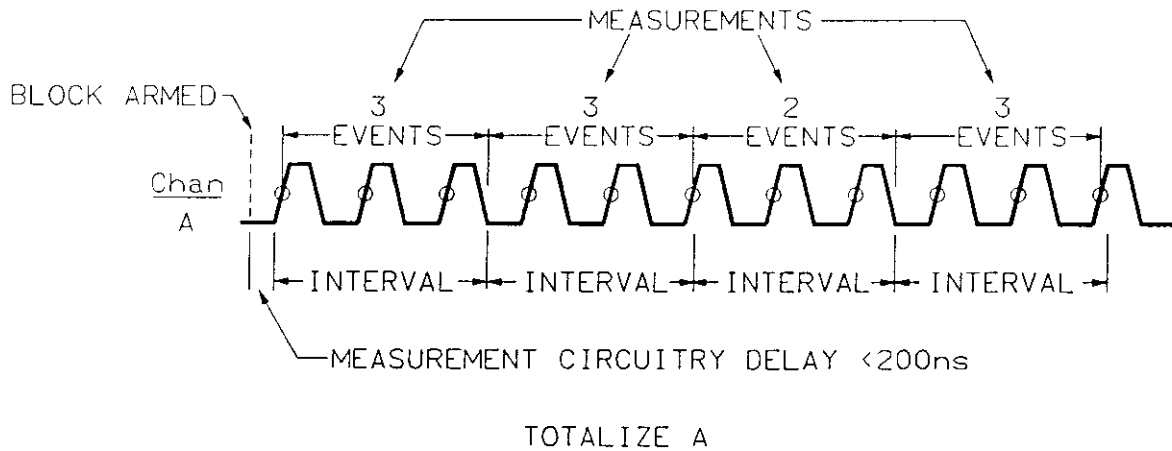

WF28\_N3

*Figure 3-1. Totalize | Interval Sampling*

**DESCRIPTION OF DIAGRAM:**

- A block of measurements can begin as soon as the Analyzer is ready. The block is armed when the Analyzer is ready to begin measuring.
- Samples are then taken at each interval. The measurements end at the conclusion of each interval. The sample interval is repetitive and asynchronous with the signal being measured. Four measurements are shown.

Range of Interval = 100 ns to 8.0 s. Can be set with a resolution of 100 ns.



### TOTALIZE MEASUREMENT WITH EDGE SAMPLING ARMING

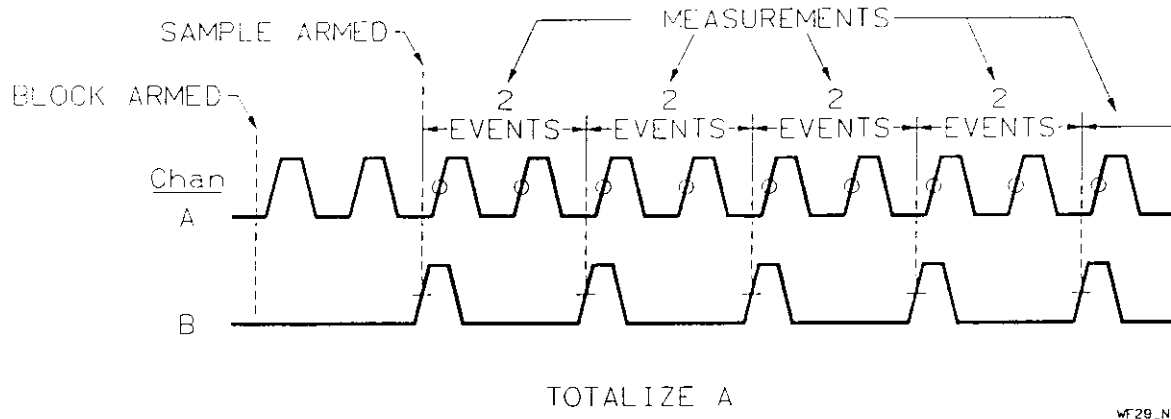

Figure 3-2. Totalize | Edge Sampling

#### DESCRIPTION OF DIAGRAM:

- A block of measurements can begin as soon as the Analyzer is ready. The block is armed when the Analyzer is ready to begin measuring.
- Samples are armed at a positive edge on Channel B. One sample is collected per arming edge. An edge is required before each sample. Four measurements are shown.

#### NOTE

*The period of the sample arm signal should not exceed 8.0 s.*



### TOTALIZE MEASUREMENT WITH EDGE/EDGE ARMING

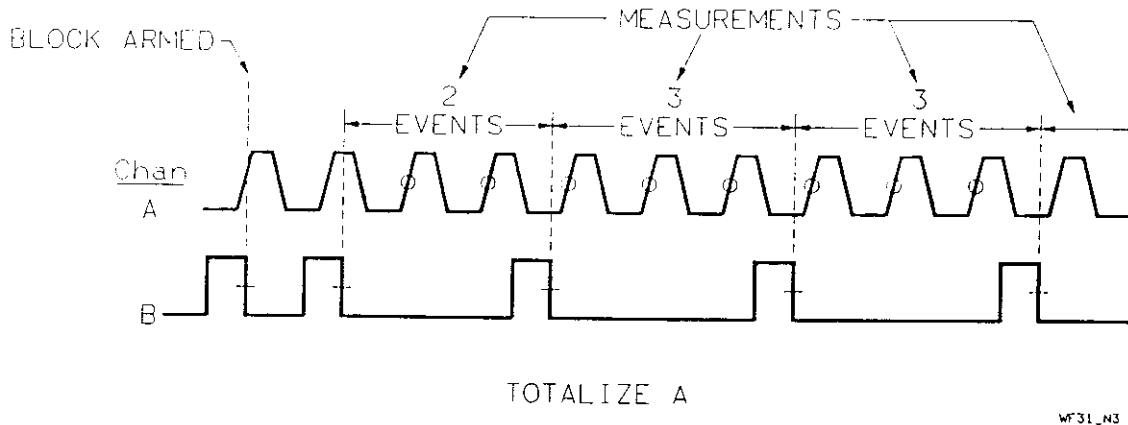

Figure 3-4. Totalize | Edge/Edge

#### DESCRIPTION OF DIAGRAM:

- A block of measurements can begin after a negative edge on Channel B. The block is armed when the edge occurs on Channel B.
- Samples are collected at a negative edge on Channel B. One sample is taken per edge. An edge is required for each sample. Three measurements are shown.

#### NOTE

*The period of the sample arm signal should not exceed 8.0 s.*



### TOTALIZE MEASUREMENT WITH TIME/INTERVAL ARMING

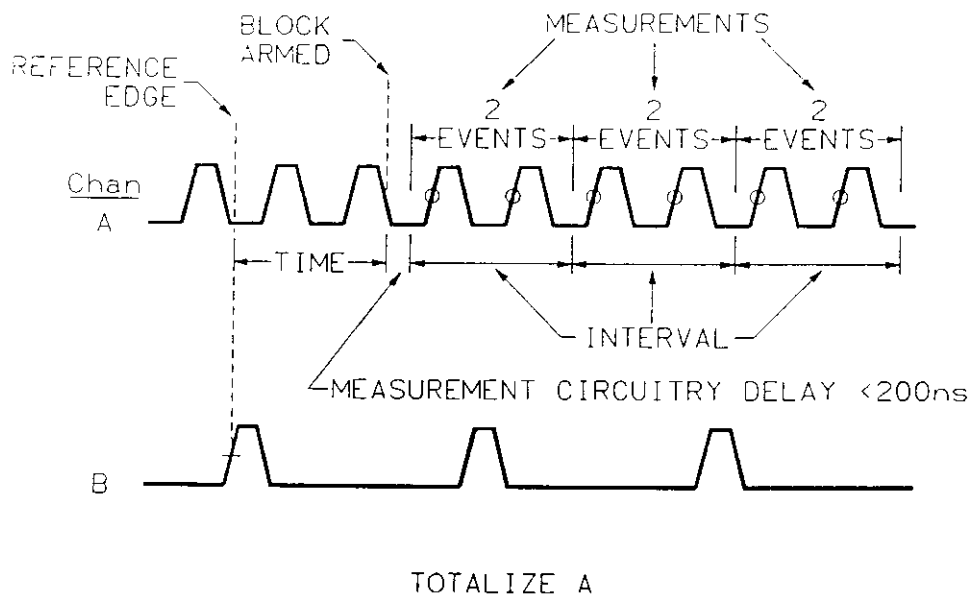

WF33\_N3

Figure 3-6. Totalize | Time/Interval

#### DESCRIPTION OF DIAGRAM:

- A block of measurements can begin after a selectable time delay. The start of the time delay is referenced to a positive edge on Channel B.
- Samples are collected at each interval. The measurements end at the conclusion of each interval. The sample interval is repetitive and asynchronous with the signal being measured. Three measurements are shown.

Range of Time = 2 ns to 8.0 s. Can be set with a resolution of 2 ns.

Range of Interval = 100 ns to 8.0 s. Can be set with a resolution of 100 ns.



## AUTOMATIC MEASUREMENTS

For the following measurements, no parameters need to be specified on the Function and Input menu screens. There is a set of default values for each of the measurements. Some of these default values can be modified. This information is listed for each measurement under "Parameters that can be modified."

The automatic measurements are:

- Rise Time
- Fall Time
- Positive Pulse Width
- Negative Pulse Width
- Duty Cycle
- Peak Amplitude

### NOTE

---

*It is recommended that you press the **Preset** key to return instrument settings to default values after making any of these automatic measurements. There are instances where the settings selected for the automatic measurements could cause confusion with the setup of a new measurement.*

---





Parameters that can be modified:

- Input screen:

- Trigger Event Mode
  - Trigger Event Level

**NOTE** 

---

*At least 8 ns must elapse between arming edge and the first sample of each measurement.*

---



Parameters that can be modified:

- Input screen:

- Trigger Event Mode
- Trigger Event Level

**NOTE** \_\_\_\_\_

*At least 8 ns must elapse between the arming edge and the first sample of each measurement.*

---



Parameters that can be modified:

- Input screen:

Trigger Event Mode

Trigger Event Level

### TECHNICAL COMMENT

---



*Time Interval or  $\pm$  Time Interval measurement functions could also be used to make positive or negative pulse width measurements. The advantages of using TI or  $\pm$  TI are the ability to:*

- *measure longer pulse widths*
- *measure every pulse rather than every other pulse*
- *use different arming modes*

*When using a time interval function to measure pulse width, set the measurement channel to A  $\rightarrow$  B on the Function menu. On the Input menu, set the Input Channels to Common, the slope of Channel A to Pos and B to Neg for positive pulse widths.*

---

### NOTE

---

*At least 8 ns must elapse between the arming edge and the first sample of each measurement.*

---



Parameters that can be modified:

- Input screen:

Trigger Event Mode  
Trigger Event Level

TECHNICAL COMMENT 

---



*Time Interval or  $\pm$  Time Interval measurement functions could also be used to make positive or negative pulse width measurements. The advantages of using TI or  $\pm$  TI are the ability to:*

- *measure longer pulse widths*
- *measure every pulse rather than every other pulse*
- *use different arming modes*

*When using a time interval function to measure pulse width, set the measurement channel to A  $\rightarrow$  B on the Function menu. On the Input menu, set the Input Channels to Common, the slope of Channel A to Neg and B to Pos for negative pulse widths.*

---

NOTE 

---

*At least 8 ns must elapse between the arming edge and the first sample of each measurement.*

---





Parameters that can be modified:

- Input screen:
  - Trigger Event Mode
  - Trigger Event Level

**NOTE** 

---

*At least 8 ns must elapse between the arming edge and the first sample of each measurement.*

---



---

 TECHNICAL COMMENT
 

---



The Modulo 360 option for both Phase and Phase Deviation measurements can be used to keep the range of phase results limited to a total span of 360°. Modulo 360 is useful for comparing phases on multi-burst signals.

The HP 5372A implementation of Modulo 360 does not compute cumulative phase MOD 360, which would provide results in the range 0° to 360°. Instead the upper 180° of the MOD 360 function (180° to 360°) are translated to the range -180° to 0°. This is done to avoid the display scatter that would take place on the Time Variation graph when the displayed phase results crossed the 0° boundary.

For the case where your phase results are crossing the 180° boundary, you can introduce an offset to move the boundary away from your data. By adding an offset value before the modulus operation, then subtracting the offset after the modulus operation, the boundary is moved to 180°+ (offset)°.

This is accomplished as follows:

1. Select the Math menu and set Math "On" for:
  - Channel A for a Phase A rel B measurement
  - Channel A for a Phase B rel A measurement
  - Channel A for a Phase Deviation A measurement
  - Channel B for a Phase Deviation B measurement
2. Move the menu cursor down to the Offset field and enter the number of degrees by which you want to move the boundary. The formula for the displayed result is shown at the bottom of the screen. It reads:

"Display = (Result+Offset) MOD 360 - Offset"

The new range for Modulo 360 is (-180° - Offset) to (180° - Offset).

---



Range of Interval = 100 ns to 8.0 s. Can be set with a resolution of 100 ns.

- Edge/Interval — A block of measurements will be delayed, or held off, until an edge occurs on Channel A, B, or External Arm. Also, the time between phase measurements can be set.

Range of Interval = 100 ns to 8.0 s. Can be set with a resolution of 100 ns.



Parameters that can be modified:

- Function screen:  
Channel option
- Input screen:  
Input Channels





### **Averaged Results for Phase/Time Deviation Measurements**

The feature of time-stamping the arming edge makes it possible for the HP 5372A to average multiple blocks of measurements. When you select one of the two arming modes from the previous page for a multiple-block Phase Deviation or Time Deviation measurement, a field on the Function menu will allow selection of "Averaged Results" (the other option is "All Results"). The averaged results are shown on the Numeric screen, the Time Variation and Event Timing graphs. If the total number of measurements selected exceeds the size of internal memory, "Averaged Results" is the only option available. See the Note below.

#### **NOTE**

---

*Block averaging is available for both Phase Deviation and Time Deviation under the following conditions:*

- *The arming mode is Edge Holdoff or Edge/Interval.*
  - *The number of blocks is set greater than 1.*
  - *The **Carrier Frequency** field is set to Manual on the Math menu. The appropriate carrier frequency value should be entered.*
-



Phase Deviation results can be displayed in two different formats, depending on the setting of the Math menu **Phase Result** field. The choices are:

- Modulo 360°
- Cumulative

Modulo 360 displays results in the range of  $-180^\circ$  to  $+180^\circ$ . When set to Cumulative, the phase deviation results are referenced to the first sample of the block. The results will show the cumulative phase deviation of the input signal from the reference.

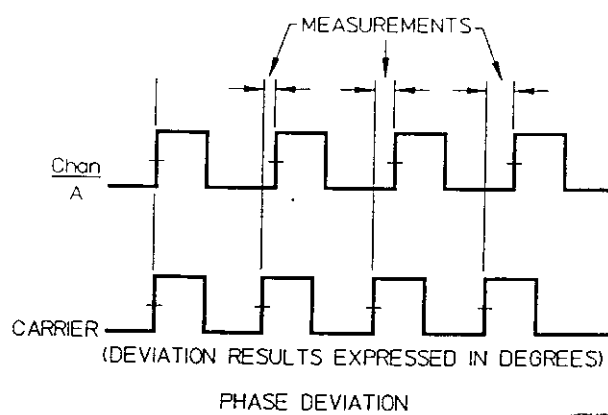

*Figure 3-15. Phase Deviation*

When the input signal leads the reference, the results are positive. Conversely, negative results indicate that the input signal lags behind the reference.

**Range:**  $-180^\circ$  to  $+180^\circ$  (Modulo 360)

$> \pm 360^\circ$  (Cumulative)



Defaults:

- Measurement Channel – A

Arming Modes:

- Automatic — Measurements are taken as quickly as possible.
- Edge Holdoff — A block of measurements can be delayed, or held off, until an edge occurs on Channel A, B, or External Arm. The reference edge is time stamped, so all measurements in the block are referenced to the holdoff edge. Averaging of multiple blocks is supported. See the introduction to phase and time deviation measurements for the conditions that allow block averaging.
- Interval Sampling — The time between phase deviation measurements can be set.

Range of Interval = 100 ns to 8.0 s. Can be set with a resolution of 100 ns.

- Edge/Interval — A block of measurements will be delayed, or held off, until an edge occurs on Channel A, B, or External Arm. Also, the time between phase deviation measurements can be set. The reference edge is time stamped, so all measurements in the block are referenced to the holdoff edge. Averaging of multiple blocks is supported. See the introduction to phase and time deviation measurements for the conditions that allow block averaging.

Range of Interval = 100 ns to 8.0 s. Can be set with a resolution of 100 ns.

**NOTE**

---

*When using the Edge Holdoff or Edge/Interval arming modes, in order to display the carrier on the Numeric screen, you must set the Numeric screen softkey, Expand, to On.*

---



For each block of measurements, the time deviation starts at zero and accumulates.

When the input signal leads the reference, the results are positive. Conversely, negative results indicate that the input signal lags behind the reference.

**Range:**  $> \pm 1$  reference period

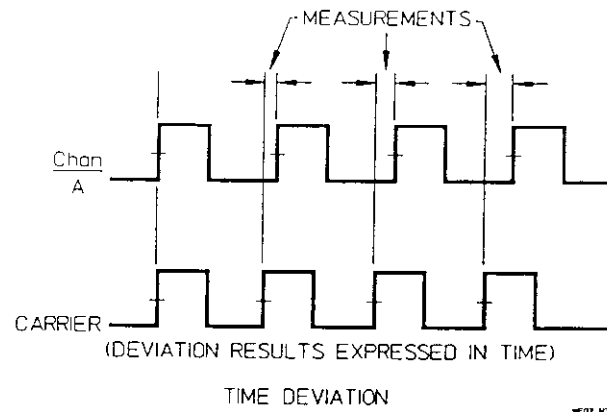

*Figure 3-16. Time Deviation*

#### Defaults:

- Measurement Channel – A

#### Arming Modes:

- Automatic — Measurements are made as quickly as possible.
- Edge Holdoff — A block of measurements will be delayed, or held off, until an edge occurs on Channel A, B, or External Arm. The edge is time stamped, so all measurements in the block are referenced to the holdoff edge. Averaging of multiple blocks is supported. See the introduction to phase and time deviation measurements for more about the conditions that allow block averaging.
- Interval Sampling — The time between Time Deviation measurements can be set.





## Contents of Chapter

---

Chapter Overview .....	4-1
Information Pointers .....	4-2
What Are Histogram Measurements? .....	4-3
Advantages and Limitations of Histogram Measurements .....	4-3
Advantages of Histogram Measurements .....	4-3
Limitations of Histogram Measurements .....	4-4
Function Menu .....	4-5
Measurement Field .....	4-5
Channel Field .....	4-5
Issues to Consider .....	4-5
How to Avoid Bin Overflow .....	4-5
Pre-trigger/TI Detect .....	4-9
Measurement Acquisition Types .....	4-11
1 Block of N Measurements .....	4-11
M Blocks of N Measurements / Fast Arm .....	4-12
M Blocks of N Measurements / Big Bin .....	4-14
Single Block / Pre-trigger .....	4-16
Multiple Blocks of N Measurements / Pre-trigger .....	4-18
M Blocks of N Measurements / Pre-trigger or # of Meas .....	4-20
1 Block of N Measurements / Pre-trigger or # of Meas .....	4-22
Graph Limits .....	4-24
Boundary Fields .....	4-25
Center .....	4-25
Span .....	4-25
Start .....	4-25
Bin Width .....	4-25
Numeric Results .....	4-27
Main Menu .....	4-28
Set Param / Meas # .....	4-28
Prior Page / Next Page .....	4-28
Formats Menu .....	4-29
WINDOW MARGIN ANALYSIS .....	4-31
Introduction .....	4-31
What Is Window Margin Analysis? .....	4-31
Window Margin Calculations .....	4-34



**Combined** In the combined mode, the resulting histogram is "folded" about the window center, summing the overlapping histogram bins. This one-sided distribution is integrated to derive a combined margin curve. Both a single combined margin (CM) value and the aggregate noise and offset information for the combined data is displayed. Refer to *Figure 4-31*.

*Figure 4-31.*  
Data-to-data margin  
information can be viewed  
in the combined mode.

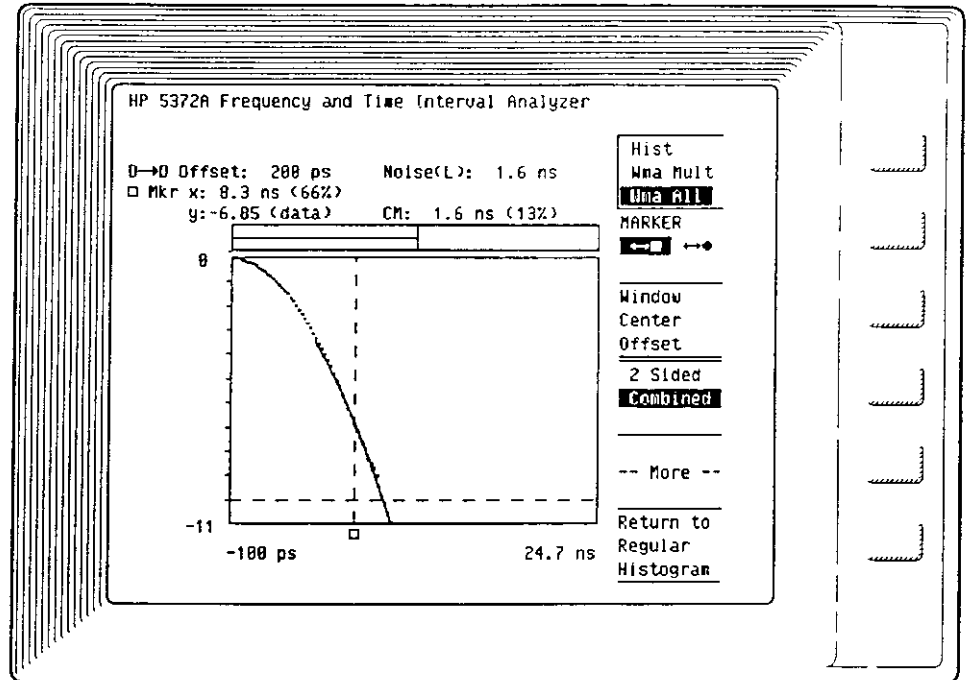



As Figure 4-29 shows, the display may look similar to the original histogram display, although it is actually both the early and late single-sided integrals of each distribution. The center of the window is denoted by a solid line extended from the panorama display.

Figure 4-29.  
The Wma Mult display for the data-to-data measurement allows you to examine the margin for each distribution separately. Here, the information corresponding to an interval across the 2-zero spacing distribution is analyzed ( $\leftrightarrow$  ● marker position).

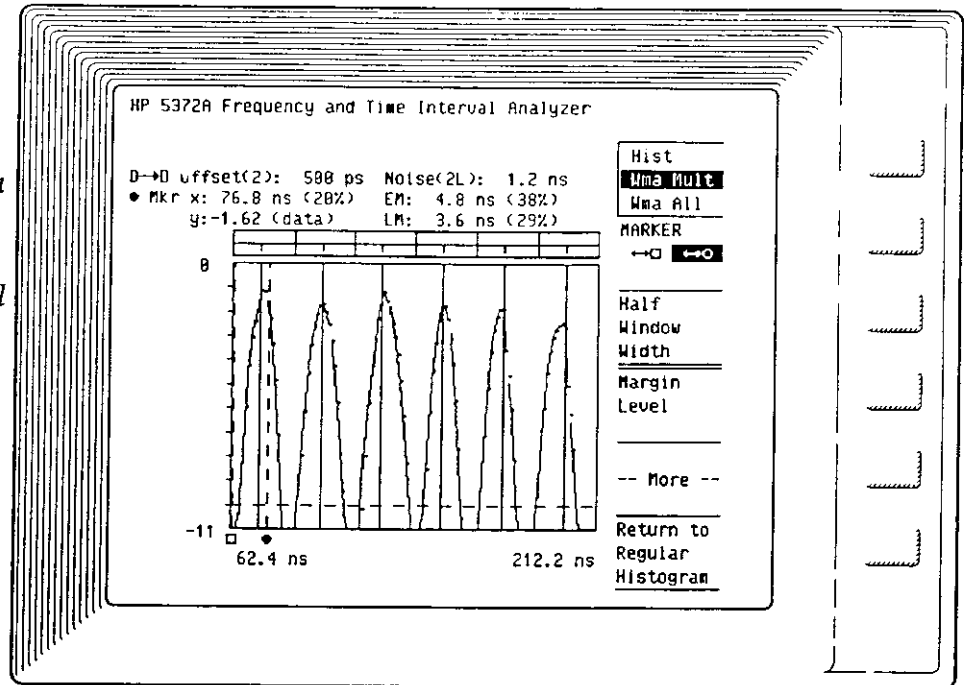

Actual measured data points are denoted as small squares. The HP 5372A's extrapolated curve fit is shown as a solid line. The data is fit through data points from 1.5 sigma and greater. Excluding sigmas smaller than 1.5 avoids curve fit errors resulting from data offset effects. If there is an insufficient number of data points below 1.5 sigma, the HP 5372A will indicate that it cannot extrapolate through the data. (Refer to Figure 4-20 depicting the extrapolation method using error rate sigmas versus decoding window.)

You can move the marker through the measured data or the extrapolated data. The marker value readout is selected by pressing the "MARKER VAL" softkey. In either case, when the selected data type is not available, the marker displays the other type of data. The current value type is denoted next to the marker's Y value readout.



HISTOGRAM (Hist)

This display is the same as the regular histogram display, and provides a convenient reference point without exiting the window margin analysis displays (see *Figure 4-28*). Notice that the panorama display is now used to display the decoding windows. A small downward tick mark indicates window centers; tick marks extending from the top to bottom of the panorama display are the boundaries of the decoding windows. Marker features, including delta, are available with this histogram display.

*Figure 4-28.*  
*The window margin analysis histogram display for data-to-data measurements on a random RLL (2,7) data pattern (RLL=Run Length Limited coding).*

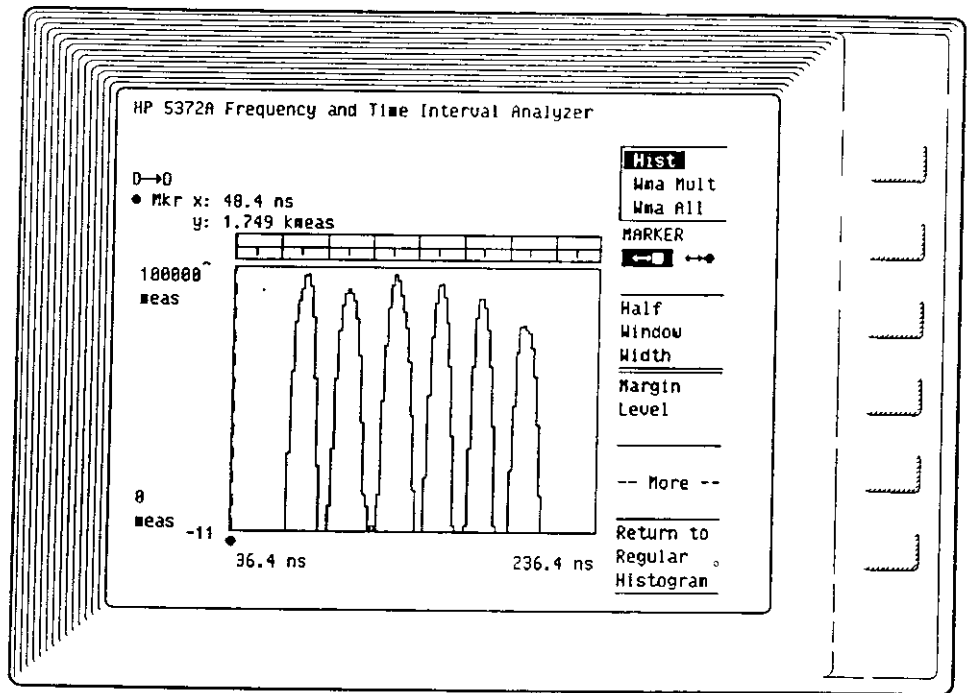





## Viewing Margin Information

Select Window Margin Analysis by choosing the "Disp" set of softkeys on the graphics result display. The Window Margin Analysis softkey appears under this selection.

To view window margin information, it is essential that the appropriate half decoding window value be entered. This is done by pressing the "Half Window Width" softkey, and entering a value in the inverse video field in the lower left corner of the display. Numeric values can be entered using the keypad and must be terminated either with the "Enter" key, or the units softkeys. The default value for the half decoding window is 100 ns.

In addition, the appropriate margin level for analysis should also be entered. As with the half decoding window size, this value is entered by pressing the "Margin Level" softkey and entering the log error rate value via the numeric keypad. The default error rate value is -10 (1 error in 1E10 bits).

A dashed horizontal line extending across the bottom of the display indicates the selected margin value. The plots are displayed with an extra index line at the bottom of the display for clarity.

The Window Center Offset softkey feature is useful for data-to-data measurements when experimenting with a fixed offset of the decoding window. This may actually increase aggregate margin if the system exhibits a predominate bit shift in one direction (e.g. asymmetric early and late window margin performance). Experimentation with this value lets you determine an optimal offset to add to the drive's data decode window circuitry. The PLL centering algorithm is disabled whenever a non-zero window center offset value is selected.



## DATA-TO-DATA MEASUREMENTS

This measurement configuration measures the time interval from data pulse to data pulse and results in multiple timing distributions. The number of distributions depends upon the particular coding scheme used by the system, as well as the data pattern being measured.

### Configuring the Measurement

To configure the HP 5372A to make data-to-data measurements and subsequently analyze the data using Window Margin Analysis, select the Histogram Continuous Time Interval A (or B) function, or Histogram Time Interval A (or B) on the Function menu. The Histogram Continuous Time Interval function is recommended if the shortest possible data-to-data interval is 75 ns or greater.

If data-to-data intervals are shorter than 75 ns when using Fast measurement mode (see "Time Interval Measurements," chapter 1), or 100 ns when using Normal measurement mode, it is recommended that the Histogram Time Interval function be used with Random or Edge/Random arming. This will insure that all possible intervals are measured and included in the histogram distributions.

Refer to chapter 5, "Arming," for more information on random sampling. The HP 5372A will recognize when a single channel measurement has been selected and will analyze the histogram results as data-to-data measurements.

### NOTE

---

*Hewlett-Packard recommends that the HP 5372A be used to measure the digital pulse train after the zero crossing detector in a disk or tape drive read channel, rather than measure the analog readback signal. The HP 5372A features a wideband comparator input which may be inappropriate to detect and measure the precise timing of the peaks of the analog input signal.*

---



WINDOW MARGIN  
ANALYSIS ALL (Wma All)

Margin information can be examined as early and late margin, as well as combined margin. These modes are selected using the "2-sided, Combined" softkey.

Actual measured data points are denoted as small squares. The HP 5372A's extrapolated curve fit is shown as a solid line. The data is fit through data points from 1.5 sigma and greater. Excluding sigmas smaller than 1.5 avoids curve fit errors resulting from offset effects. If there are insufficient data points below 1.5 sigma, the HP 5372A will indicate that it cannot extrapolate through the data. (Refer to *Figure 4-20* depicting the extrapolation method using error rate sigmas versus decoding window.)

You can move the cursor through either the measured data or the extrapolated data. The marker value readout is selected by pressing the "MARKER VAL" softkey. In either case, when the selected data is not available, the marker displays the other type of data. The current value type is denoted next to the marker's Y value readout.

*Figure 4-25.*  
Data-to-clock margin  
information can be viewed  
in the two-sided mode: early  
and late window margin.

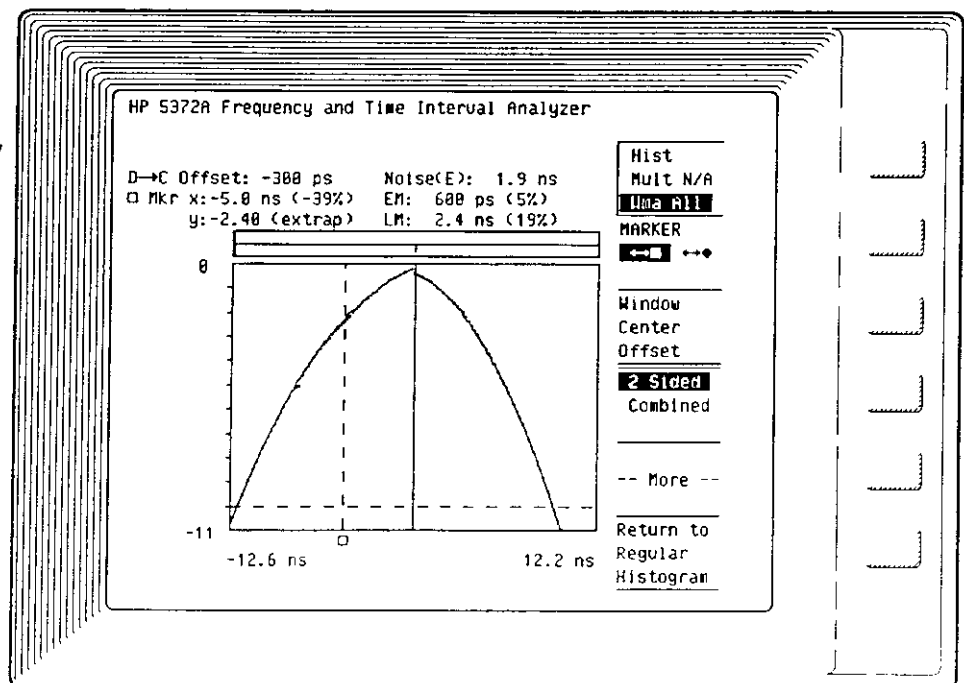



## **Viewing Margin Information**

Select Window Margin Analysis by choosing the "Disp" set of softkeys on the graphics result display. The Window Margin Analysis softkey appears under this selection.

To view window margin information, it is essential that the appropriate half decoding window value be entered. This is done by pressing the "Half Window Width" softkey, and entering a value in the inverse video field in the lower left corner of the display. Numeric values can be entered using the keypad and must be terminated either with the "Enter" key, or the units softkeys. The default value for the half decoding window is 100 ns.

In addition, the appropriate margin level for analysis should also be entered. As with the half decoding window size, this value is entered by pressing the "Margin Level" softkey and entering the log error rate value via the numeric keypad. The default error rate value is -10 (1 error in 1E10 bits).

A dashed horizontal line extending across the bottom of the display indicates the selected margin value. The plots are displayed with an extra index line at the bottom of the display for clarity.

For the data-to-clock measurement configuration, it is possible that different electrical path lengths may exist, causing a fixed offset in the time interval results. In addition, access to data and clock signals may be at the input and output of a PLL integrated circuit. In this case, a net offset corresponding to the propagation delay through the device may cause a bias in time interval results. In either case, the measurement bias may appear as a bit shift in the data decoding window. You may remove this offset by shifting the decoding window center. This value can be entered by pressing the "Window Center Offset" softkey. A negative value shifts the window in the early direction (to the left relative to the position of the data), and a positive value shifts the window in the late direction (to the right relative to the position of the data).

You may also find this feature useful when experimenting with a fixed offset of the decoding window. This offset can actually increase aggregate margin if the system exhibits a predominate bit shift in one direction (e.g. asymmetric early and late window margin performance). Experimentation with this value lets you determine an optimal offset to add to the drive's data decode window circuitry.





Figure 4-22.  
Data-to-clock, Pos edge to Pos  
edge configuration, with  
histogram centered about half  
window value

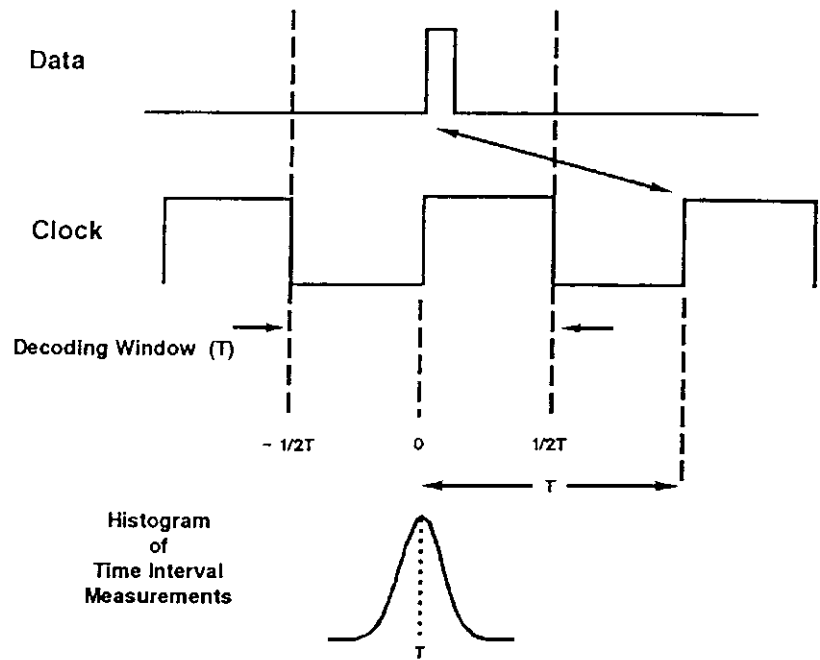

#### NOTE

Hewlett-Packard recommends that the HP 5372A be used to measure the digital pulse train after the zero crossing detector in a disk or tape drive read channel, rather than measure the analog readback signal. The HP 5372A features a wideband comparator input which may be inappropriate to detect and measure the precise timing of the peaks of the analog input signal.



Return to Regular Histogram      Pressing this softkey exits the Window Margin Analysis functions and returns to the regular histogram display.

## DATA-TO-CLOCK MEASUREMENTS

This measurement configuration measures the time interval from the data to the clock and results in a single distribution relative to the clock window.

### Configuring the Measurement

To configure the HP 5372A to make data-to-clock measurements and subsequently analyze the data using Window Margin Analysis, select the Histogram Time Interval function, Channel A→B, on the Function menu. (Histogram Time Interval, Channel B→A will also work. See note below).

#### NOTE

---

*It is recommended that you connect the data signal to channel A, and the clock signal to channel B. Histogram Time Interval A→B will measure time intervals between data (channel A) and clock (channel B). Since a data pulse will not necessarily occur for every clock period (many coding schemes prohibit this), measuring data-to-clock rather than clock-to-data insures that a time interval measurement will only occur when a data pulse is present. This will generate a single histogram distribution, rather than multiple distributions corresponding to clock periods without data. See Figure 4-21.*

*In addition, connecting the data signal to channel A will offer the flexibility to use random event sampling on the data signal (random sampling is only available for channel A). Note that it is desirable to randomize on the data signal rather than the clock signal.*

---



## The HP 5372A Window Margin Displays and Softkeys

To access Window Margin Analysis after acquiring a Histogram Continuous Time Interval or Histogram Time Interval measurement, select the "Disp" (Display) set of softkeys. This is done by repeatedly pressing the topmost softkey on the Graphics Result Display until this selection is highlighted. When the Disp choice is selected, Window Margin Analysis will appear as a softkey selection.

Three types of displays are available in Window Margin Analysis:

- Hist (Histogram display).
- Mult (Multiple distributions analyzed separately. Available for data-to-data measurements only).
- All (All of the data is combined into a single distribution for analysis).

These displays are selected by repeatedly pressing the topmost softkey in the window margin analysis mode.

### MARKERS

Two markers are available in Window Margin Analysis:  $\leftrightarrow \square$  and  $\leftrightarrow \bullet$ . The X and Y values are displayed for the currently selected marker in the upper left corner of the display. X values are in time (seconds). In addition, the corresponding percentage of half window is also displayed inside parentheses. Y values indicate the corresponding error rate. "Data", "Extrap", or "No Data" is denoted next to the Y value showing whether the indicated error rate was determined using actual measured data, extrapolated or curve fit data, or no data exists (measured or extrapolated) for that particular window position.

### SOFTKEY SELECTIONS

**MARKER**      Pressing this softkey selects either the  $\leftrightarrow \square$  or  $\leftrightarrow \bullet$  marker as the active marker.

**Marker Delta**      Pressing this softkey selects whether marker results are displayed as the (X,Y) coordinates of the active marker, or the difference (delta) between (X,Y) coordinates of the two markers. The inactive marker values are subtracted from the active marker values.



## Data-to-Data Measurements versus Data-to-Clock Measurements

The HP 5372A's Histogram Time Interval and Histogram Continuous Time Interval modes can be used to acquire the data distributions. These features acquire and process time interval data on-the-fly, letting you gather large measurement sizes in a short period of time. Since window margin is computed from the histogram data, the HP 5372A gives you the flexibility to analyze timing data with histogram and/or window margin features.

Two measurement configurations can be used to acquire the histogram distribution. You can configure the HP 5372A to measure the time interval from data-pulse to data-pulse or the time interval from data-to-clock. The data-to-data measurement results in multiple timing distributions, the number of which depends upon the particular coding scheme used by the system, as well as the data pattern being measured. The data-to-clock measurement results in a single distribution relative to the clock window, relating directly to the discussion above.

It should be noted that the two measurement configurations are fundamentally different, and will not necessarily deliver identical results. Data-to-data measurements differ from data-to-clock measurements in at least three ways:

1. Data-to-data measurements do not include the actual clock, and so measurement results do not include PLL effects: jitter, low-frequency tracking offsets, etc. The HP 5372A centers the data-to-data distributions in a similar fashion as the PLL to force the total bit shift across the distributions to zero. This technique is described in further detail under data-to-data measurements.

Data-to-data measurements may be of interest when it is desirable to separate PLL effects from data effects, if particular timing distributions are to be examined, or when a clock signal is not available.

2. Data-to-data measurements also differ fundamentally from data-to-clock measurements in the information included with each measurement. When measuring the time interval from data edge-to-data edge, a single time interval measurement includes the timing displacement and noise effects of both data edges (the start and stop of the time interval). In the case of data-to-clock measurements, assuming that the clock has relatively little noise or offset, each time interval measurement represents the timing effects of a single data edge.





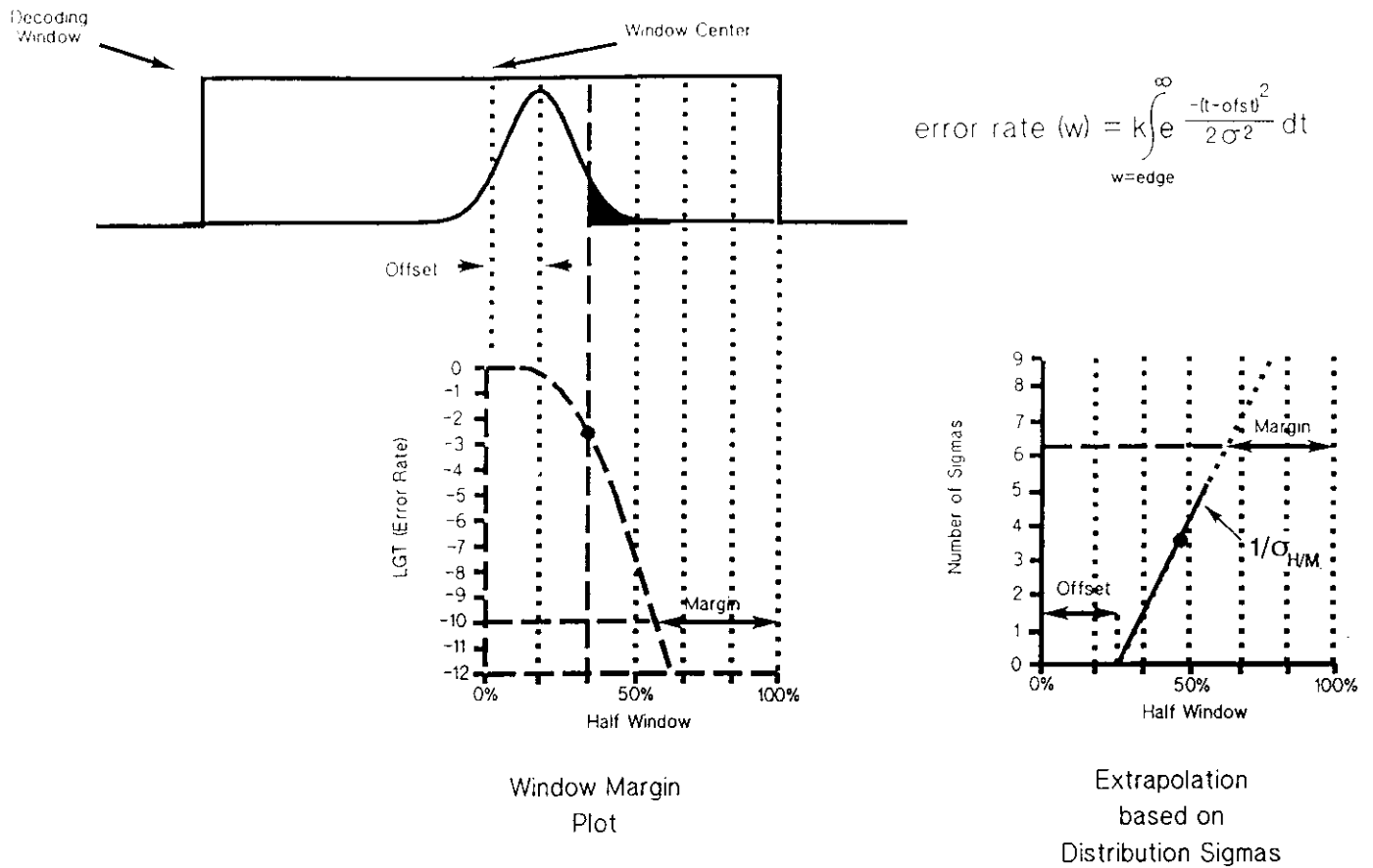

Figure 4-20. The Window Margin plot describes the shape of the data distribution within the decoding window.

The HP 5372A can display similar margin information by first acquiring the data distribution as a histogram, or probability density function (pdf). An error rate corresponding to half window position can be computed as the area of the histogram between the bin position in the half window and the edge of the window, normalized by the area of the entire histogram. Essentially the pdf represented by the histogram can be integrated to create the cumulative probability density function.



In general, the location of data pulses relative to the decoding window will have some distribution. *Figure 4-19* shows that the distribution can be characterized by two effects: a displacement from the center of the window corresponding to aggregate timing offsets (static bit shift), and a width or sigma, corresponding to the random bit shift effects or aggregate timing "noise". The error rate of the system can be described by the area of the distribution truncated by the decoding window.

*Figure 4-19.*  
The distribution of data pulses relative to the decoding window can be characterized by an offset from the window center, and a width, or sigma.

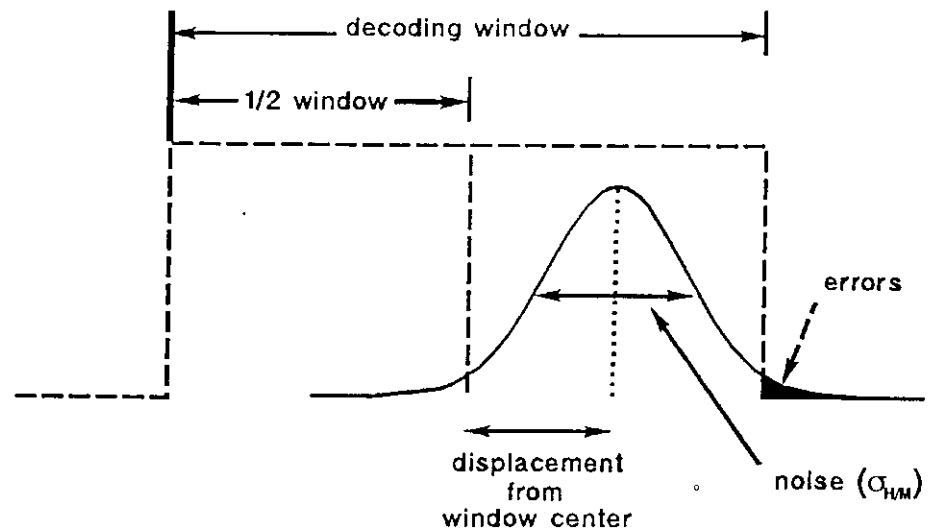

A data pulse can be displaced one half of the window from the window center (either early or late) before resulting in an error. The transitions will be moved from their nominal written position by static peak shift effects and noises during the reading and writing process. The individual noise processes (read and write) combine to create one aggregate noise in the data decoding window. Therefore, the margin for a particular error rate is defined as the difference between half the decoding window and the sum of the offsets and the number of aggregate noise sigmas that correspond to a particular error rate.



## **WINDOW MARGIN ANALYSIS**

---

### **INTRODUCTION**

This section describes how to use the Window Margin Analysis feature of the HP 5372A. It is only available when using the Histogram Continuous Time Interval or Histogram Time Interval functions. These functions are explained in the previous portion of this chapter.

### **WHAT IS WINDOW MARGIN ANALYSIS?**

Window Margin Analysis is a special type of processing which uses data acquired with the HP 5372A's Histogram Continuous Time Interval or Histogram Time Interval functions. This analysis is useful when characterizing any synchronous, or clocked, data channel, although it is particularly focused at disk drive test. The subsequent explanations therefore use magnetic disk drive examples to illustrate the various capabilities and features.

For a disk drive system, the presence of a data pulse within a decoding window corresponds to a data "one". The absence of a pulse relative to the decoding window corresponds to a data "zero". The data decoding window is derived from a readback clock. In the disk drive case, this clock is usually derived using a PLL (Phase Lock Loop) to reconstruct the original transfer clock used in the write process. The input to the PLL is the readback data.



**Formats Menu**

There is only one results format available for Histogram measurements. It shows bin values and the number of measurements in each bin.





## NUMERIC RESULTS

The Numeric screen displays a listing of the Histogram bin values and the number of measurements that landed in each bin.

Figures 4-16 and 4-17 show typical result displays. They are the first "page" of results and the last "page" of results. Note the indicator bar alongside the softkeys. It shows the portion of results currently displayed. The column on the left of the screen is the starting value of each bin. On the right is the column listing the number of measurements that landed in each bin. The bin width is 200 ps for this measurement sequence. This is the smallest bin width available. Although 2,000 bins are used for every measurement sequence, not every bin received data. This is evident from the number of empty bins displayed.

Figure 4-16.  
Numeric Results of  
Histogram Measurement,  
First Page

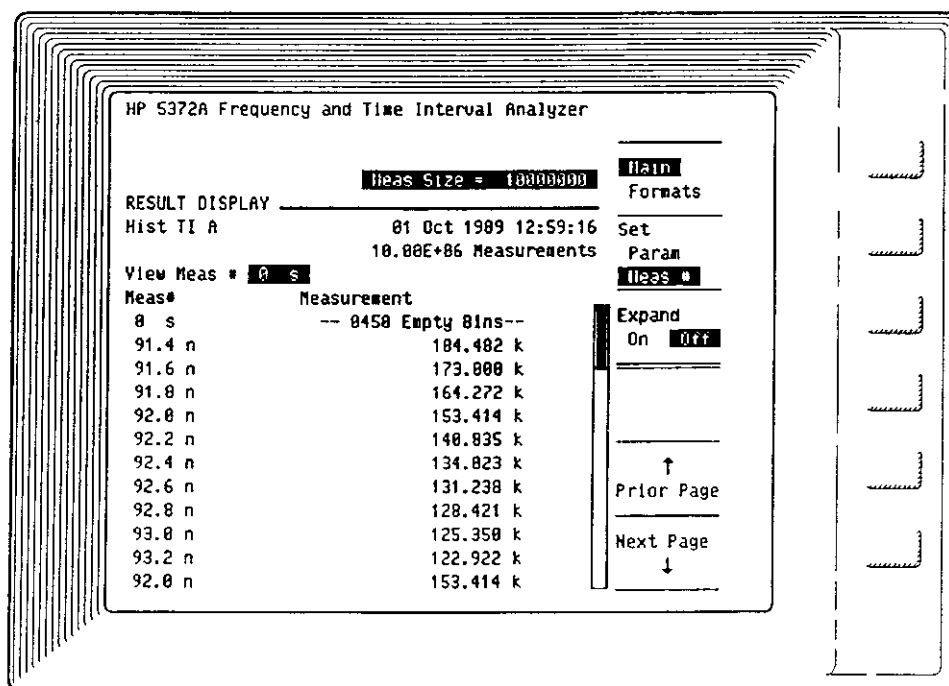



## Boundary Fields

There are four fields for setting the Histogram graph boundaries as shown in *Figure 4-14*.

*Figure 4-14.*  
*Histogram Graph*  
*Boundary Fields*

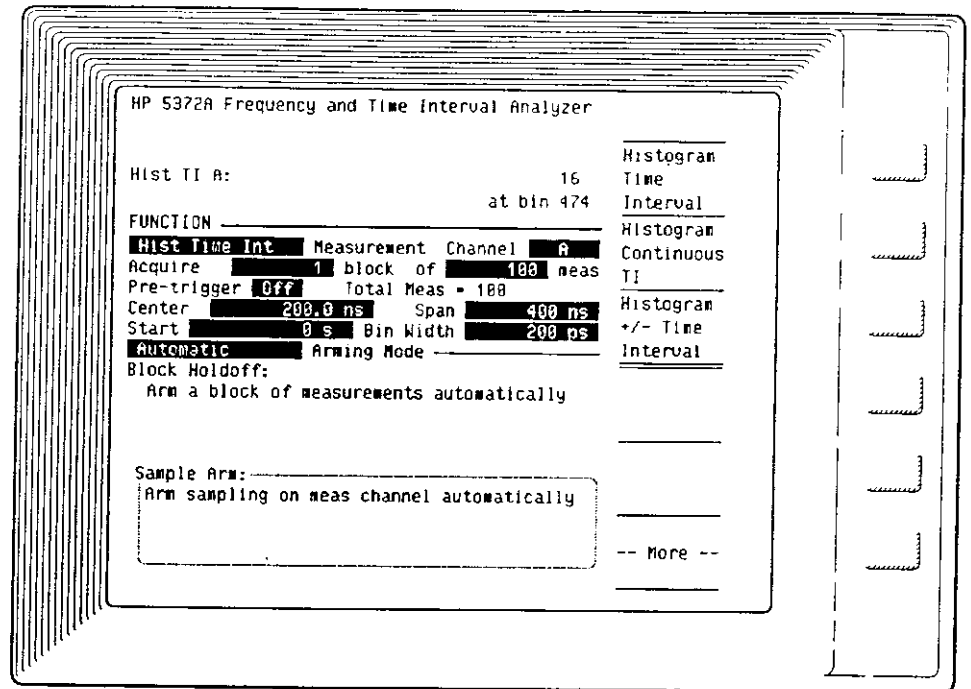

**CENTER** **Center** sets the time center of the histogram. Changing this value causes a corresponding change in the start value. The span and bin width values are not affected.

**SPAN** **Span** sets the width of the histogram.

$$\text{Span} = 2,000 \times \text{Bin Width}$$

400 ns to 3.3554432 s (Normal Mode)

400 ns to 128 us (Fast Mode)

**START** **Start** sets the left boundary of the histogram, that is, the minimum time limit. Changing this value causes a corresponding change in the center value. The span and bin width remain unchanged.

**BIN WIDTH** **Bin Width** sets the width of the bins in the histogram. Changing this value changes the center and span values, but not the start. The number of bins is fixed at 2,000. The span of the histogram is always 2,000 times the width of one bin.



**Pause/Continue:**

Pressing the **Pause** softkey on the Graphics screen Disp (Display) menu suspends the measurement sequence and displays the accumulated results. Pressing the **Continue** softkey will resume the measurement acquisition as soon as the next sample arming condition is satisfied.

**NOTE** 

---

*If the pre-trigger event is a signal on the External Arm input, it will also be detected if it occurs during a Pause. The measurement sequence will then end as soon as it is continued. Of course, a pre-trigger event of a time interval value cannot be satisfied during a Pause because no measurements are taking place.*

---

### Graph Limits

Prior to making a Histogram measurement, the Histogram graph boundaries must be set according to the range of measurements to be collected. Only measurement results occurring in this range will be displayed by the graph. *Figure 4-13* shows the results of setting the Histogram graph limits incorrectly for the range of measurements collected. Notice the "min" and "max" indicators showing the number and location of measurements that occurred outside the graph limits. All the measurements fell outside the range of the Histogram boundaries.

Figure 4-13.  
Incorrectly Set  
Graph Limits

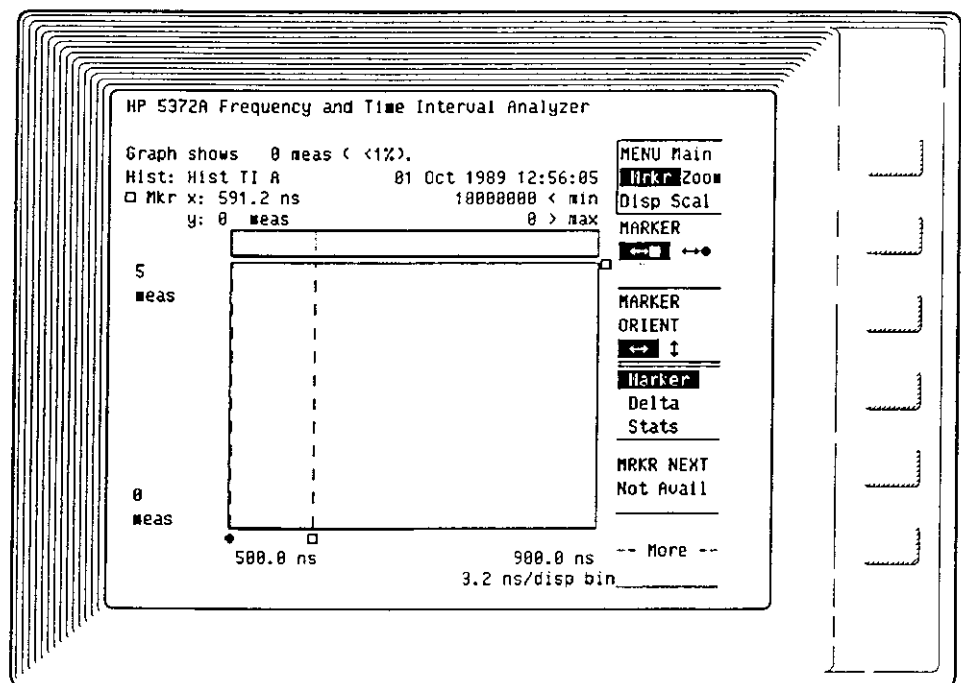

---

**NOTE**

---

*If a value is entered for the number of blocks or the number of measurements that would cause this limit (1E12) to be exceeded, the last value entered takes priority and forces a reduction in the other value.*

---

**Bin Capacity:**

Each Histogram bin can hold up to 16,777,215 measurements. With the allowed total number of measurements, bins could overflow. If that happens, measurements landing in the overflowed bins will not be included in the Histogram graph or the Numeric results screen. (See "Issues to Consider" above for an explanation of bin overflow.) The increased bin capacity feature ("Big Bin") is not available for this measurement setup.

**Pause/Continue:**

Pressing the **Pause** softkey on the Graphics screen Disp (Display) menu suspends the measurement sequence and displays the accumulated results. Pressing the **Continue** softkey will resume the measurement acquisition as soon as the next block holdoff and sample arming conditions are satisfied.

---

**NOTE**

---

*If the pre-trigger event is a signal on the External Arm input, it will also be detected if it occurs during a Pause. The measurement sequence will end as soon as it is continued. If an External Arm pre-trigger event occurs between blocks, it will not be detected. Of course, a pre-trigger event of a time interval value cannot be satisfied during a Pause, or between blocks, because no measurements are taking place.*

---

1 BLOCK OF N  
MEASUREMENTS /  
PRE-TRIGGER OR # OF MEAS

Figure 4-12.  
Setup 7: One Block —  
Measurements End on  
Pre-trigger or  
Measurements.

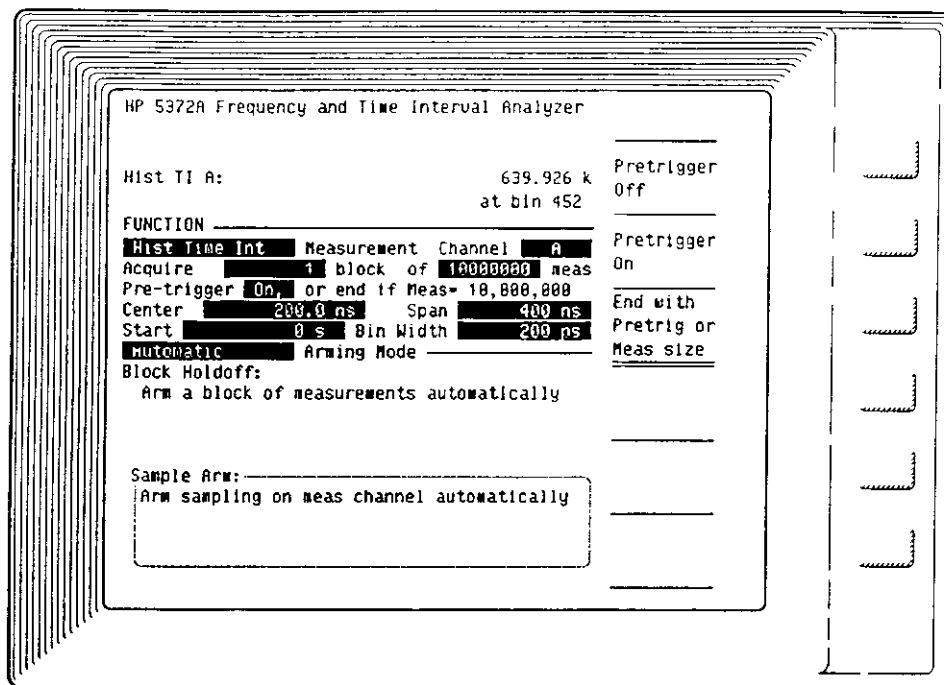

### Measurement Acquisition Size:

M (number of blocks) = 1

N (number of measurements) = 1 to 2,000,000,000 (2E9)

The exponent key (Exp) can be used for exponential entry when specifying the number of measurements.

The HP 5372A will accumulate measurements until the pre-trigger event occurs, or the specified number of measurements have been collected, whichever comes first.

### Bin Capacity:

Each Histogram bin can hold up to 16,777,215 measurements. With the allowed total number of measurements, bins could overflow. If that happens, measurements landing in the overflowed bins will not be included in the Histogram graph or the Numeric results screen. (See "Issues to Consider" above for an explanation of bin overflow.) The increased bin capacity feature ("Big Bin") is not available for this measurement setup.



**Bin Capacity:**

Each Histogram bin can hold up to 16,277,215 measurements before overflowing. With the total number of measurements allowed, bins could overflow. If that happens, measurements landing in the overflowed bins will not be included in the Histogram graph or the Numeric results screen. (See "Issues to Consider" above for an explanation of bin overflow.) The increased bin capacity feature ("Big Bin") is not available for this measurement setup.

**Pre-trigger Setting:**

The pre-trigger event is specified on the Pre-trigger menu. It can be a signal at the External Arm input or a measured time interval using the TI Detect feature. See chapter 10, "Pre-trigger Menu," for more on TI Detect. The pre-trigger amount is fixed at 100%. (See "Issues to Consider" above for an explanation of pre-trigger with Histogram measurements).

**Pause/Continue:**

Pressing the **Pause** softkey on the Graphics screen Disp (Display) menu suspends the measurement sequence and displays the accumulated results. Pressing the **Continue** softkey will resume the measurement acquisition as soon as the next sample arming conditions are satisfied.

**NOTE**

---

*If the pre-trigger event is a signal on the External Arm input, it will also be detected if it occurs during a Pause. The measurement sequence will end as soon as it is continued. If an External Arm pre-trigger event occurs between blocks, it will not be detected. Of course, a pre-trigger event of a time interval value cannot be satisfied during a Pause, or between blocks, because no measurements are taking place.*

---

M BLOCKS OF N  
MEASUREMENTS /  
PRE-TRIGGER OR # OF MEAS

Figure 4-11.  
Setup 6: M Blocks —  
Measurements End on  
Pre-trigger or M

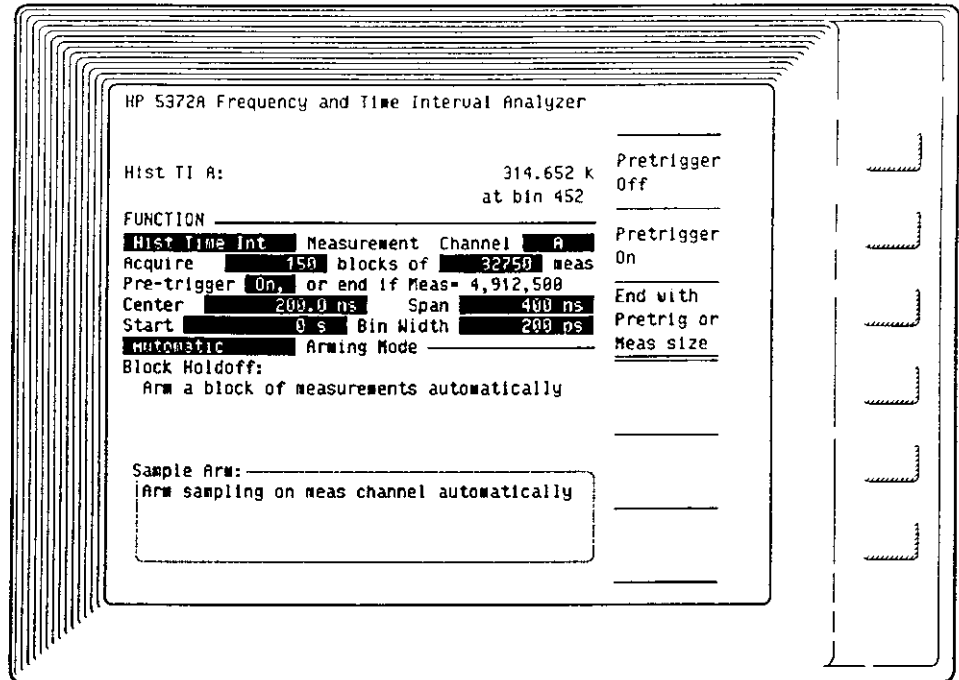

**Measurement Acquisition Size:**

M (number of blocks) = 2 to 99,999,999

N (number of measurements per block) =

1 to 65,500 (Hist. CTI)

1 to 32,750 (Hist. TI, Hist. ± TI)

The HP 5372A will accumulate measurements until the pre-trigger event occurs, or the specified number of measurements have been collected, **whichever comes first**. Total size of measurement (blocks x measurements) can equal 1,000,000,000,000 (1E12).

**Pre-trigger Setting:**

The pre-trigger event is specified on the Pre-trigger menu. It can be a signal at the External Arm input or a measured time interval using the TI Detect feature. See chapter 10, "Pre-trigger Menu," for more on TI Detect. The pre-trigger amount is fixed at 100%. (See "Issues to Consider" above for an explanation of pre-trigger with Histogram measurements).

**Pause/Continue:**

Pressing the **Pause** softkey on the Graphics screen Disp (Display) menu suspends the measurement sequence and displays the accumulated results. Pressing the **Continue** softkey will resume the measurement acquisition as soon as the sample arming conditions are satisfied.

**NOTE**

---

*If the pre-trigger event is a signal on the External Arm input, it will also be detected if it occurs during a Pause. Of course, a pre-trigger event of a time interval value cannot be satisfied during a Pause because no measurements are taking place.*

---

MULTIPLE BLOCKS OF N  
MEASUREMENTS /  
PRE-TRIGGER

Figure 4-10.  
Setup 5: Multiple Blocks —  
Measurements End on  
Pre-trigger

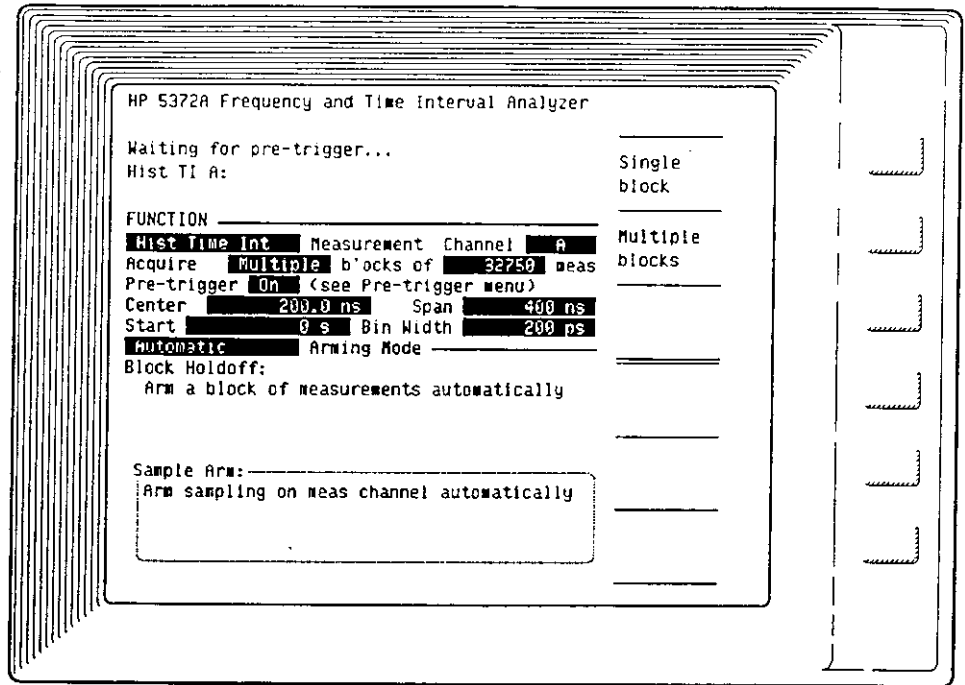

**Measurement Acquisition Size:**

N (number of measurements per block) =

1 to 65,500 (Hist. CTI)

1 to 32,750 (Hist. TI, Hist. ± TI)

The HP 5372A will accumulate measurements until the pre-trigger event occurs. The pre-trigger event ends the measurement sequence. The acquisition will stop at 1,099,511,627,775 ( $2^{40}-1$ ) measurements if no pre-trigger event is detected.

For a comparison of Single block vs. Multiple blocks with Pre-trigger, refer to chapter 10, "Pre-trigger Menu".

**Bin Capacity:**

For the "Big Bin" setting, the effective capacity of each Histogram bin is 2,000,000,000,000,000 (2E15) total measurements. The increased capacity is achieved by clearing the accumulated counts from the Histogram bins and storing the results in software after each block of measurements is acquired. There is still a bin capacity of 16,777,215 measurements before overflow FOR EACH BLOCK. The processing necessary to clear all the bins and store accumulated counts slows the rate of data acquisition. If it is important in your application to avoid the possibility of overflowing a bin, set the number of measurements per block to no greater than 16,777,215. (See "Issues to Consider" above for an explanation of bin overflow.)

**Pause/Continue:**

Pressing the **Pause** softkey on the Graphics screen Disp (Display) menu suspends the measurement sequence and displays the accumulated results. Pressing the **Continue** softkey will resume the measurement acquisition as soon as the block holdoff and sample arming conditions are satisfied.

**Update While/After:**

Selecting the **While** softkey on the Graphics screen Disp (Display) menu will cause the accumulated Histogram graph results to be updated after each block is acquired. Selecting the **After** softkey causes the Histogram graph results to be displayed only at the completion of the entire measurement acquisition. **While** is the default setting.

SINGLE BLOCK /  
PRE-TRIGGER

Figure 4-9.  
Setup 4: Single Block —  
Measurements End on  
Pre-trigger

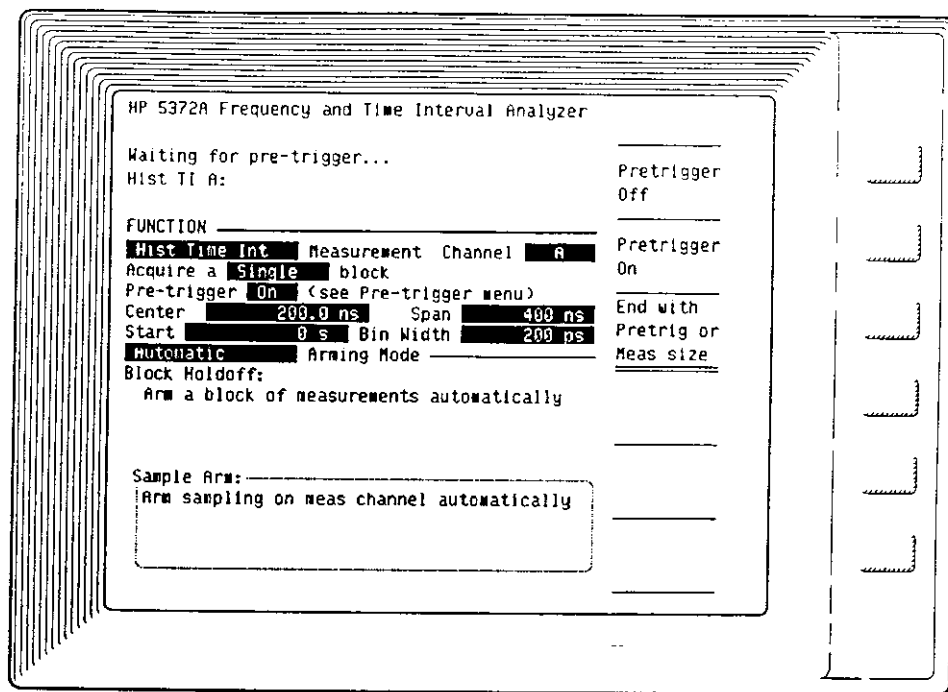

**Measurement Acquisition Size:**

The HP 5372A will accumulate measurements until the pre-trigger event occurs. The pre-trigger event ends the measurement sequence. The acquisition stops after 1,099,511,627,775 ( $2^{40}-1$ ) measurements if no pre-trigger event is detected.

**Bin Capacity:**

Each Histogram bin can hold up to 16,777,215 measurements. With the allowed total number of measurements, bins could overflow. If that happens, measurements landing in the overflowed bins will not be included in the Histogram graph or the Numeric results screen. (See "Issues to Consider" above for an explanation of bin overflow.) The increased bin capacity feature ("Big Bin") is not available for this measurement setup.

**NOTE**

---

*If a value is entered for the number of blocks or the number of measurements that would cause this limit (1E12) to be exceeded, the last value entered takes priority and forces a reduction in the other value.*

---

**Bin Capacity:**

Each Histogram bin can hold up to 16,777,215 measurements before overflowing. Any additional measurements landing in an overflowed bin are not included in the Histogram graph or the Numeric screen results. Use the "Big Bin" feature described below when you need greater bin capacity for larger measurements. (See "Issues to Consider" above for an explanation of bin overflow.)

**Pause/Continue:**

Pressing the **Pause** softkey on the Graphics screen Disp (Display) menu suspends the measurement sequence and displays the accumulated results. Pressing the **Continue** softkey will resume the measurement acquisition as soon as the the block holdoff and sample arming conditions are satisfied.

M BLOCKS OF N  
MEASUREMENTS / BIG BIN

Figure 4-8.  
Setup 3: M Blocks —  
Increased Bin Height Limit

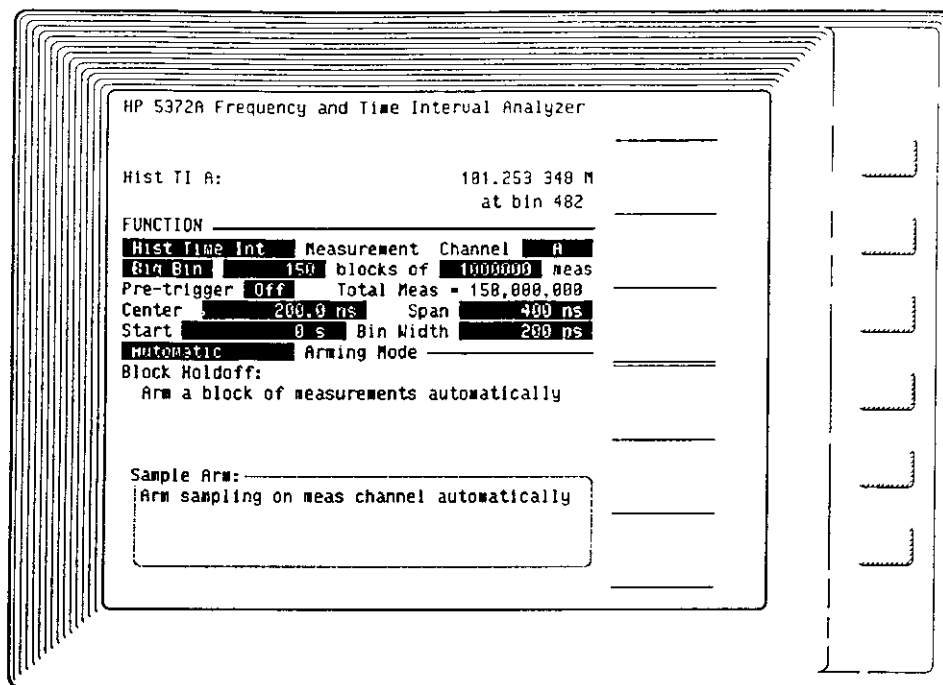

**Measurement Acquisition Size:**

M (number of blocks) = 2 to 99,999,999

N (number of measurements per block) = 1 to 2,000,000,000 (2E9)

The exponent key (Exp) can be used for exponential entry when specifying the number of measurements.

Total size of measurement (blocks x measurements) can equal 2,000,000,000,000,000 (2E15).

**NOTE**

*If a value is entered for the number of blocks or the number of measurements that would cause this limit (2E15) to be exceeded, the last value entered takes priority and forces a reduction in the other value.*



## Measurement Acquisition Types

There are seven configurations for specifying the method for acquiring Histogram measurements. They are each described in the following paragraphs. There is an example setup for each type and information on any limitations that may exist.

### 1 BLOCK OF N MEASUREMENTS

Figure 4-6.  
Setup 1: One Block

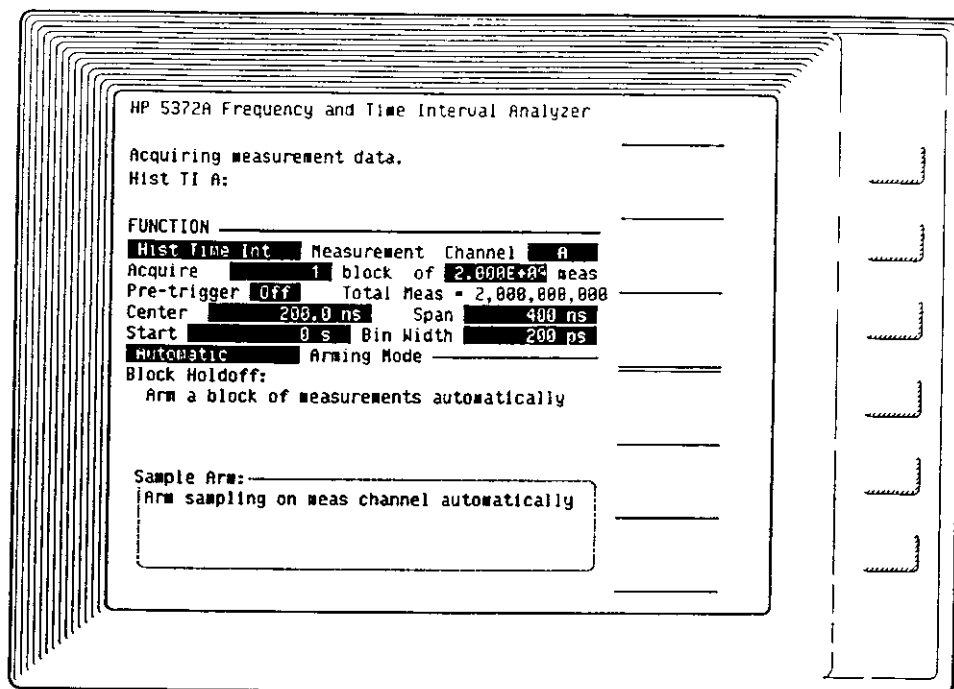

#### Measurement Acquisition Size:

$N$  (number of measurements) = 1 to 2,000,000,000 (2E9)

The exponent key (**Exp**) can be used for exponential entry when specifying the number of measurements.

#### Bin Capacity:

Each Histogram bin can hold 16,777,215 measurements before overflowing. Any additional measurements landing in an overflowed bin are not included in the Histogram graph or the Numeric screen results. Use the "Big Bin" feature described below if a bin overflow would be inappropriate for your measurement application. (See "Issues to Consider" above for an explanation of bin overflow.)

**Pause/Continue:**

Pressing the **Pause** softkey on the Graphics screen Disp (Display) menu suspends the measurement sequence and displays the accumulated results. Pressing the **Continue** softkey will resume the measurement acquisition as soon as the sample arming conditions are satisfied.

**M BLOCKS OF N MEASUREMENTS / FAST ARM**

Figure 4-7.  
Setup 2: M Blocks —  
Fast Arm Between Blocks

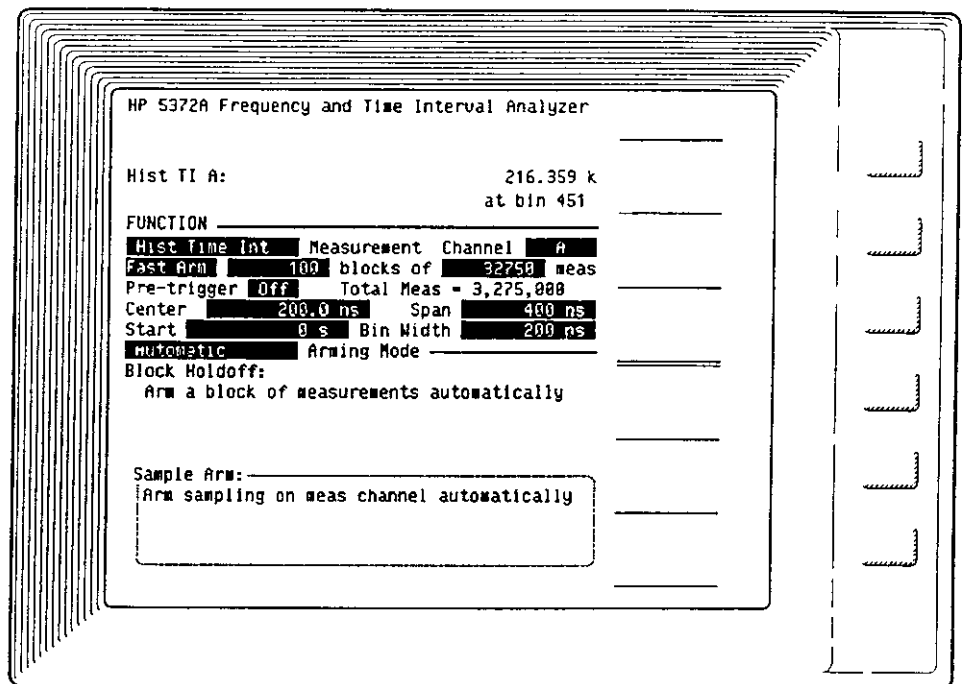

**Measurement Acquisition Size:**

M (number of blocks) = 2 to 99,999,999

N (number of measurements per block) =

1 to 65,500 (Hist. CTI)

1 to 32,750 (Hist. TI, Hist. ± TI)

Total size of measurement (blocks x measurements) can equal 1,000,000,000,000 (1E12).

Figure 4-5.  
Function Menu  
Configuration To Avoid  
Bin Overflow

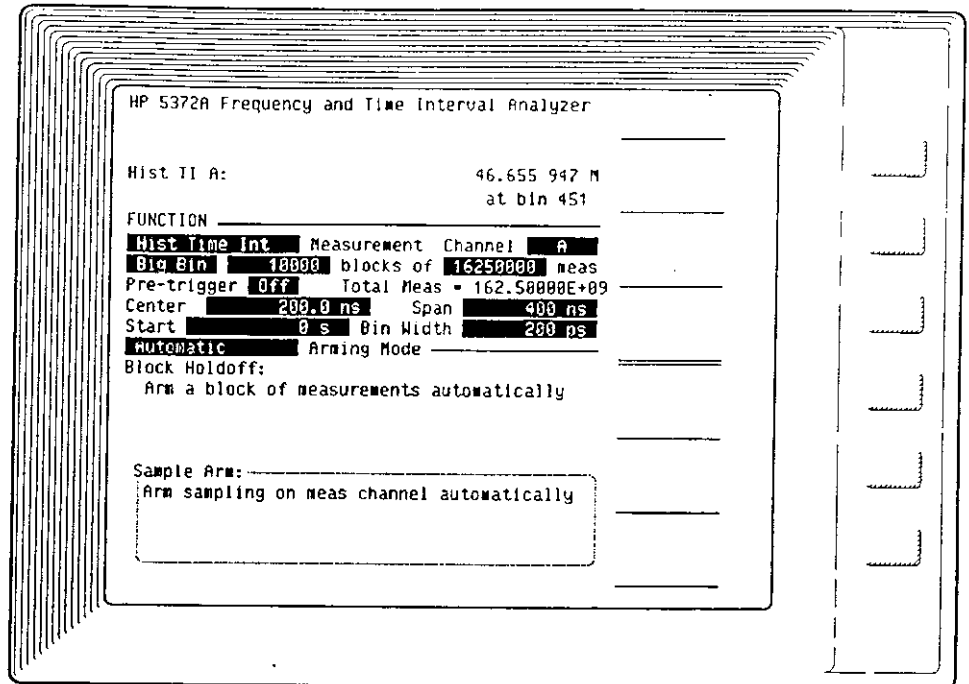

#### PRE-TRIGGER/TI DETECT

The Pre-trigger feature makes it possible to capture measurement data that occurs before some specified event. It is an alternative method for ending data acquisition (the other being an end of data acquisition once the specified number of measurements have been collected).

Pre-trigger operates somewhat differently for Histogram measurements versus all other measurement functions. When making Histogram measurements with pre-trigger, there is no selectable amount of pre-trigger as with the other functions. Only 100% pre-trigger is allowed. This means that all data from the first measurement to the pre-trigger event is captured. No data is discarded. Acquisition stops at 1,099,511,627,775 ( $2^{40}-1$ ) measurements if a pre-trigger event is not detected.

The pre-trigger event is specified on the Pre-trigger menu. As with the other measurement functions, the pre-trigger event can be designated as a signal at the External Arm input or a measured time interval using the TI Detect feature. There is an explanation of this feature in chapter 10, "Pre-trigger Menu." There is also a difference (compared with non-Histogram measurements) with setting the TI Detect condition. The TI Detect boundary values are limited to the start and stop boundaries of the Histogram measurement (specified on the Function menu). The pre-trigger event can be specified as a measured time interval value that meets one of the following conditions:

- **Above** the lower or upper boundary of the Histogram graph. (Exclusive of boundary values)
- **Below** the lower or upper boundary of the Histogram graph. (Exclusive of boundary values)
- **Inside** the lower and upper boundaries of the Histogram graph. (Inclusive of boundary values)
- **Outside** the lower and upper boundaries of the Histogram graph. (Exclusive of boundary values)

Figure 4-3 shows the Histogram graph with a marker on an overflowed bin. There is also a message at the top of the graph display to indicate a bin overflow. The Delta and Stats features operate as follows when one or more bins have overflowed:

- In Delta mode, if one or both markers are on an overflowed bin, the message, "bin overflowed" appears where the y-axis value would be displayed. If both markers are on valid measurements, the delta values for the x-axis and y-axis are displayed.
- In Stats mode, if the portion of the graph enclosed within the markers includes an overflowed bin, only the minimum and maximum values are displayed. The mean and standard deviation are not computed.

Figure 4-3.  
An Overflowed Bin

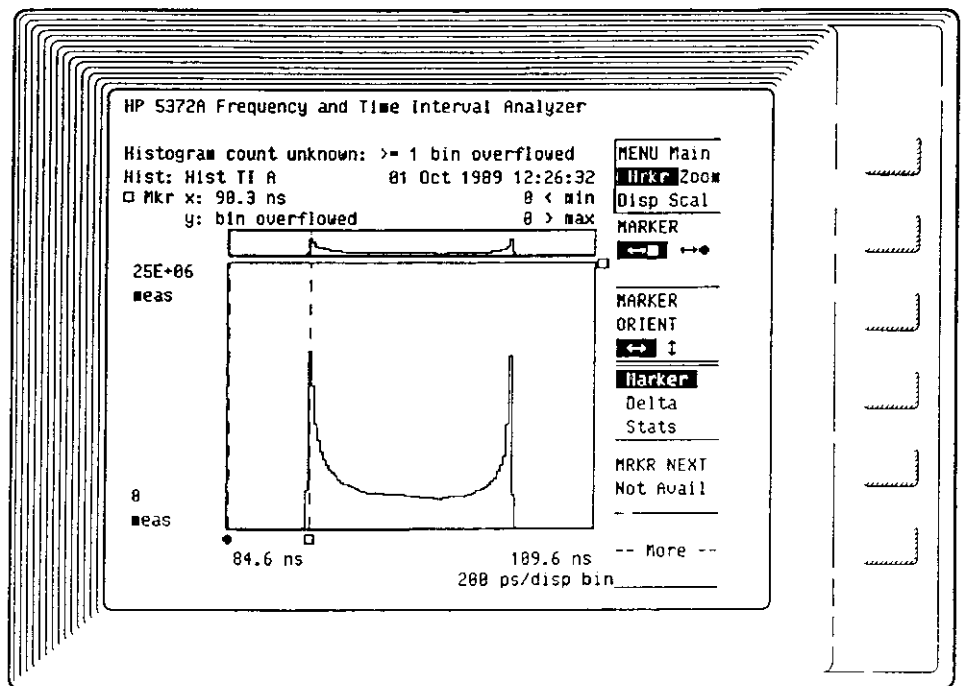
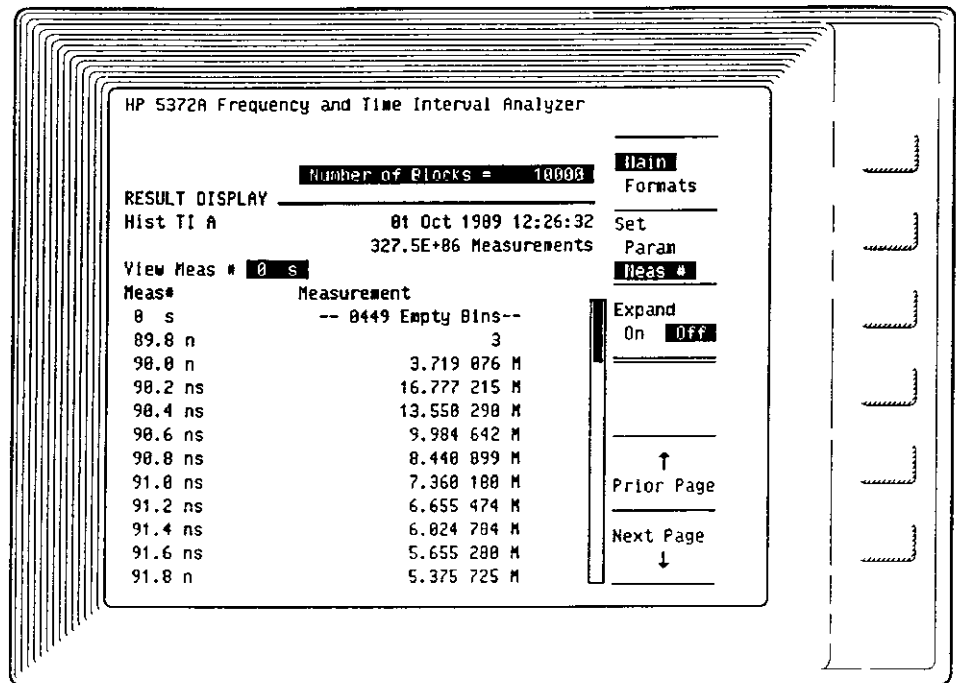

Figure 4-4 shows the Numeric results summary for the Histogram measurement. The bin that overflowed shows a count of 16,777,215 measurements.

**NOTE**

*It cannot be determined how many additional measurements landed in an overflowed bin. The Numeric screen does show the total number of measurements that have been made. This is not necessarily the number of measurements that has been graphed. Measurements that land in overflowed bins, or occur outside the boundaries of the measurement, will not be graphed.*

Figure 4-4.  
Histogram Measurement  
Numeric Results Showing  
Bin Overflow



In situations where there is a possibility of over 16 million measurements landing in one bin, use the increased bin height selection AND set the number of measurements per block to less than 16,777,215. Figure 4-5 shows an example of a setup where bins would not overflow. There will be no overflow because at the end of each block of measurements, the bins are cleared and the accumulated counts are stored in software. This processing does slow the rate of data acquisition.

**FUNCTION MENU**

The Function menu setup is a bit more involved for Histogram measurements. The sections below explain the additional fields and the limits and options for each of them.

**Measurement Field**

The Measurement field choices for Histogram measurements are:

- Histogram Time Interval
- Histogram Continuous TI
- Histogram  $\pm$  Time Interval

**Channel Field**

The Channel field options are:

For Histogram Time Interval and Histogram  $\pm$  Time Interval:

- A
- B
- A  $\rightarrow$  B
- B  $\rightarrow$  A

For Histogram Continuous Time Interval:

- A
- B

**Issues to Consider**

There are issues to consider when setting the HP 5372A to make a Histogram measurement. The size of the measurement acquisition is set by specifying a number of blocks and a number of measurements per block. The limits vary depending on the use of features such as Pre-trigger or increased Histogram bin capacity. These issues, and more, are explained below.

**HOW TO AVOID BIN OVERFLOW**

The Histogram is made up of 2,000 bins of sorted measurement data. These 2,000 bins are used for every measurement sequence. It depends on the spread of the data and the boundaries set for the Histogram with the values of Start, Center, Span, and Bin Width as to whether or not data is sorted into these bins and appear in the Histogram result. The boundaries of the Histogram will be discussed later, but an important issue when considering making large measurements (greater than 16 million measurements) is the possibility of exceeding the capacity of a Histogram bin.

Each Histogram bin can hold up to 16,777,215 measurements. Any measurements that land in an overflowed bin will not be included in the Histogram graph or in the Numeric results. This situation is not necessarily to be avoided. If you are interested in the information at the distribution tails of the Histogram, it does not matter that other portions of the Histogram distribution overflow the bins. The next three figures show what to expect when bin overflow occurs.

Figure 4-2 shows a measurement setup that could easily cause a bin overflow. The total number of measurements is over 327 million.

Figure 4-2.  
Measurement Setup Where  
Bin Overflow Could Occur

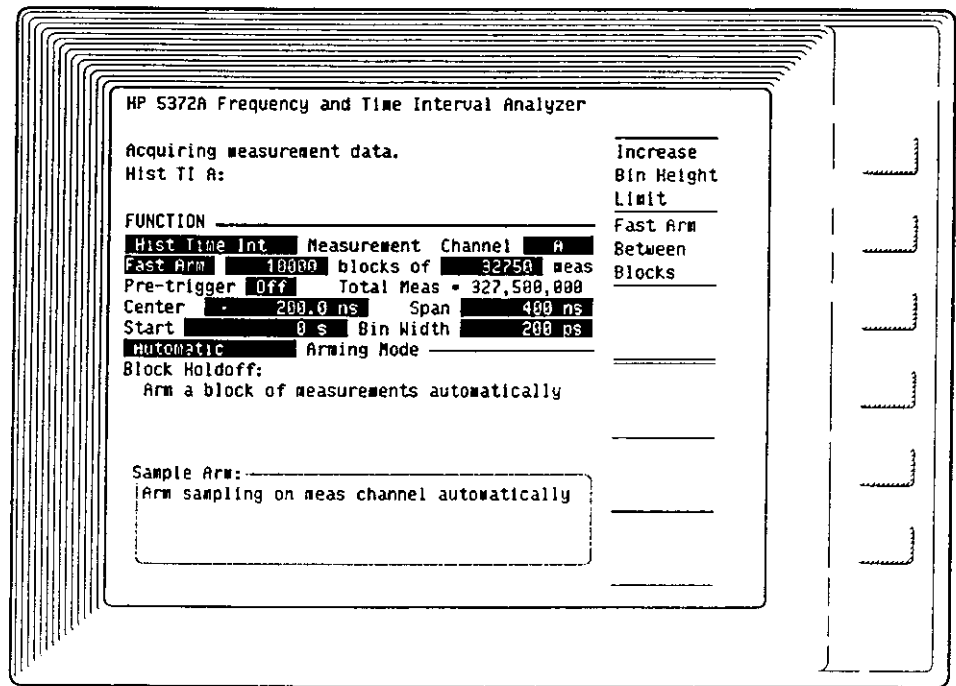



## WHAT ARE HISTOGRAM MEASUREMENTS?

Histogram measurements can acquire and analyze a large amount of data very quickly. They provide a display of a histogram distribution of time interval measurement results. Histogram measurements sort data into histogram bins at the measurement rate of the HP 5372A (up to 13.3 million measurements per second). The numeric data available consists of the histogram bin range values and the number of measurements that were sorted into each bin.

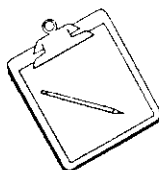

### TECHNICAL COMMENT

*Histogram measurements should not be confused with the Histogram graphs available for most measurements. There is a fundamental difference.*

*The Histogram graphs available for measurements other than Histogram measurements, are the result of software processing. No calculations or sorting of data takes place until the acquisition of each block of data is completed. This can take a sizable amount of time, even for a relatively small sample size (8,000 measurements).*

*For Histogram measurements, the HP 5372A uses hardware processing to dramatically increase the size of measurement acquisitions and decrease processing time. Sample sizes of 1,000,000 measurements, or more, can be acquired in a fraction of the time required for software-processed measurements. In order to achieve this speed of measurement and analysis, the Histogram graph is the only way the data can be viewed graphically. The numeric results are presented as the number of measurements that were sorted into each histogram bin. For a description of a Histogram graph, refer to "Graphic Results," chapter 16.*

## ADVANTAGES AND LIMITATIONS OF HISTOGRAM MEASUREMENTS

### Advantages of Histogram Measurements

There are tradeoffs to consider when deciding whether to use Histogram measurements or time interval measurements to collect your data.

This is a list of the benefits of Histogram measurements:

- A maximum acquisition size of 2,000,000,000,000 (2E15) measurements.
- Measurements are acquired at the measurement rate of the HP 5372A (up to 13.3 million measurements per second).

- A Pause/Continue feature that allows you to suspend acquisition, view the results accumulated to that point, and then resume acquisition.
- Window Margin Analysis is available for analyzing data collected with Histogram measurements from devices such as optical or magnetic disk drives.

### **Limitations of Histogram Measurements**

Here is a list of the limitations of Histogram measurements:

- Missed event information is not available for Histogram measurements. The time interval measurements do provide this information. Missed events are explained in chapter 1, "Time Interval Measurements."
- The time-sequence order in which the data was collected is not available. There is no Time Variation graph or Event Timing graph for Histogram measurements.
- You must set the boundaries of the Histogram graph prior to data acquisition. Only intervals occurring in this range will be displayed in the Histogram graph.
- When only hardware processing is used for multiple blocks of Histogram measurements (indicated by **Fast Arm** displayed on the Function menu) bins overflow at 16,777,215 counts. If there is a possibility of reaching that limit, be aware that any measurements landing in a bin after overflow will be lost and not counted in the bin but will be counted in the total. The alternative is to use the increased bin height feature called, "Big Bin." This increases bin capacity to 2,000,000,000,000,000 (2E15), but the bin limit for each block is still 16,777,215 counts. The drawback is that the increased bin height is made possible by the introduction of software processing of results between each block. The data acquisition rate is slowed as a result of the software processing.
- Binary results are not available.
- No Math menu features are available.
- Manual scaling for x-axis is not available on the Graphic screen.

# HISTOGRAM MEASUREMENTS

## CHAPTER OVERVIEW

This chapter describes Histogram measurements and how to use them. Any features that are unique to these measurements are explained in this chapter. Otherwise, references to other parts of this manual appear throughout this chapter to indicate where common feature explanations are located.

The three Histogram measurement functions are:

- Histogram Time Interval
- Histogram Continuous Time Interval
- Histogram  $\pm$  Time Interval

Figure 4-1.  
Histogram Measurement Setup

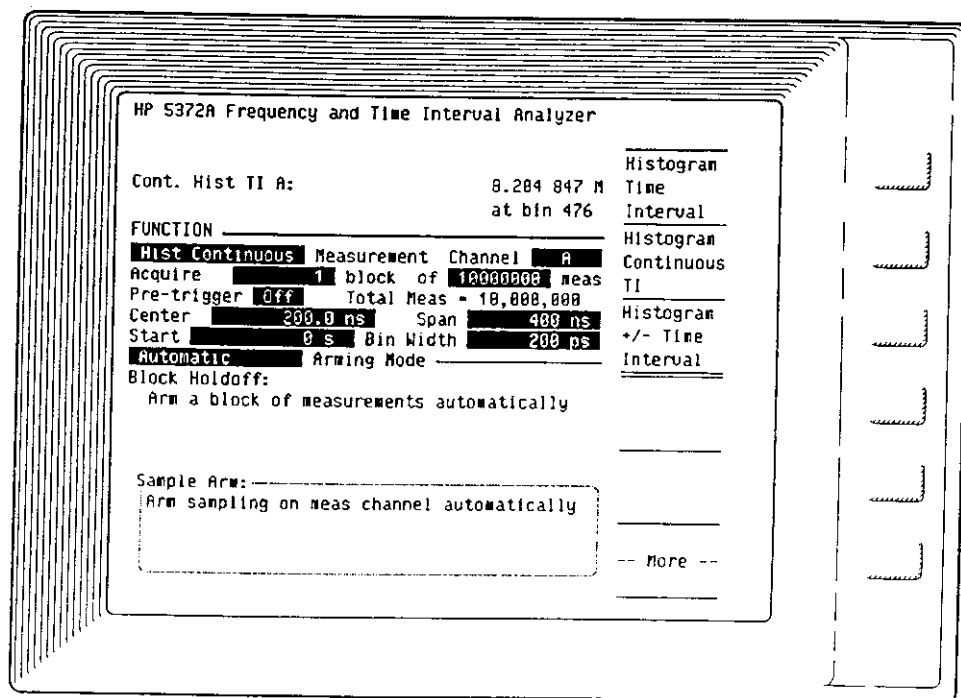

The Histogram measurements are similar to time interval measurements in the way data is collected. The differences are the rate at which data is collected and in how the data is processed and displayed.

This chapter also describes the Window Margin Analysis features available for Histogram measurements.

## INFORMATION POINTERS

The purpose of the following list is to help you find the information you need to make Histogram measurements. Since many features operate no differently for Histogram measurements, their descriptions are referenced here.

- For information about how Histogram measurements are made, that is, how samples are collected for the three types of Histogram measurements, review chapter 1, "Time Interval Measurements." For example, read about  $\pm$  Time Interval measurements when you want to know how Histogram  $\pm$  Time Interval measurements operate.
- For information about how the arming modes for Histogram measurements operate, review chapter 1, "Time Interval Measurements," and chapter 5, "Arming."
- For information about the Graphic features for Histogram measurements, review chapter 16, "Graphic Results," and this chapter.
- For information about what numeric results are available for Histogram measurements, read this chapter.
- If you want to know how to use the Pre-trigger feature with Histogram measurements, read this chapter and chapter 10, "Pre-trigger Menu."
- Window Margin Analysis is described in this chapter. Window Margin Analysis is only available for Histogram Measurements.

)

1



## Contents of Chapter

---

Arming Preview .....	5-1
Time and Events .....	5-1
What Is Arming? .....	5-2
Group vs. Individual Arming .....	5-3
Continuous and Non-Continuous Arming .....	5-5
Continuous or Non-Continuous? .....	5-8
Arming Mode Categories .....	5-8
Automatic Mode .....	5-9
Holdoff Modes .....	5-9
Sampling Modes .....	5-10
Holdoff / Sampling Modes .....	5-10
Function and Arming Mode Summary .....	5-12
Where Arming Fits In .....	5-13
Arming Screen Terms .....	5-15
Detailed Arming Mode Descriptions .....	5-22
Measurements Referenced to the Block Arming Edge .....	5-22
Averaged Results .....	5-23
Automatic Mode .....	5-24
Holdoff Modes .....	5-26
Edge Holdoff .....	5-26
Time Holdoff .....	5-28
Event Holdoff .....	5-30
Sampling Mode .....	5-31
Interval Sampling .....	5-32
Time Sampling .....	5-34
Cycle Sampling .....	5-36
Edge Sampling .....	5-38
Parity Sampling .....	5-40
Repetitive Edge .....	5-42
Repetitive Edge-Parity .....	5-44

Random Sampling .....	5-46
Holdoff/Sampling Mode .....	5-48
Edge/Interval .....	5-48
Edge/Time .....	5-50
Edge/Edge .....	5-52
Edge/Cycle .....	5-54
Edge/Event .....	5-56
Edge/Parity .....	5-58
Edge/Random .....	5-60
Time/Interval .....	5-62
Time/Time .....	5-64
Event/Interval .....	5-66
Event/Event .....	5-68
Externally Gated .....	5-70
Manual .....	5-72



**ARMING PREVIEW**

Arming is one of the most important features of the HP 5372A. With it, you tell the Analyzer when to measure. This can be of great value when trying to measure particular portions of the signal, while avoiding others.

No matter what type of measurement is being made, the HP 5372A performs these basic functions:

- Collects time and event data
- Processes data into measurements
- Displays results

Your selection of an arming mode helps determine when the data is collected. After some basic introductory material, this chapter will concentrate on how the data is captured with the use of arming modes.

**TIME AND EVENTS**

Two kinds of data are collected by the HP 5372A. They are:

- time
- events

A sample is a time count and an event count. Each sample reflects the time that has elapsed and the number of trigger events that have occurred as referenced to the first sample of the measurement block. There are internal counters to keep track of the accumulated time and events. From this time and event data, measurement results are calculated. (Refer to chapters 1, 2, and 3, for details on how samples are processed into measurement results.)

### WHAT IS ARMING?

Arming lets you specify **WHEN** the HP 5372A will begin measuring and **HOW OFTEN** it will make measurements thereafter.

The HP 5372A arming modes are structured as a two-step process. The following description of the process is applied to the Edge/Interval arming mode:

In general, the first term of the arming mode name (Edge/) specifies **WHEN** the HP 5372A can begin to acquire a group, or block, of measurements. The second term of the arming mode name (/Interval) specifies **HOW OFTEN** measurement samples within the block of measurements can be acquired. When the data for the requested number of measurements have been collected, the HP 5372A will then perform calculations on the data to compute the results.

The specifying of the arming conditions is accomplished by selecting an arming mode on the Function menu and then selecting the parameters presented for the arming mode. *Figure 5-1* shows the parameters that specify the conditions for the Edge/Interval arming mode.

Figure 5-1.  
Arming Mode Parameters

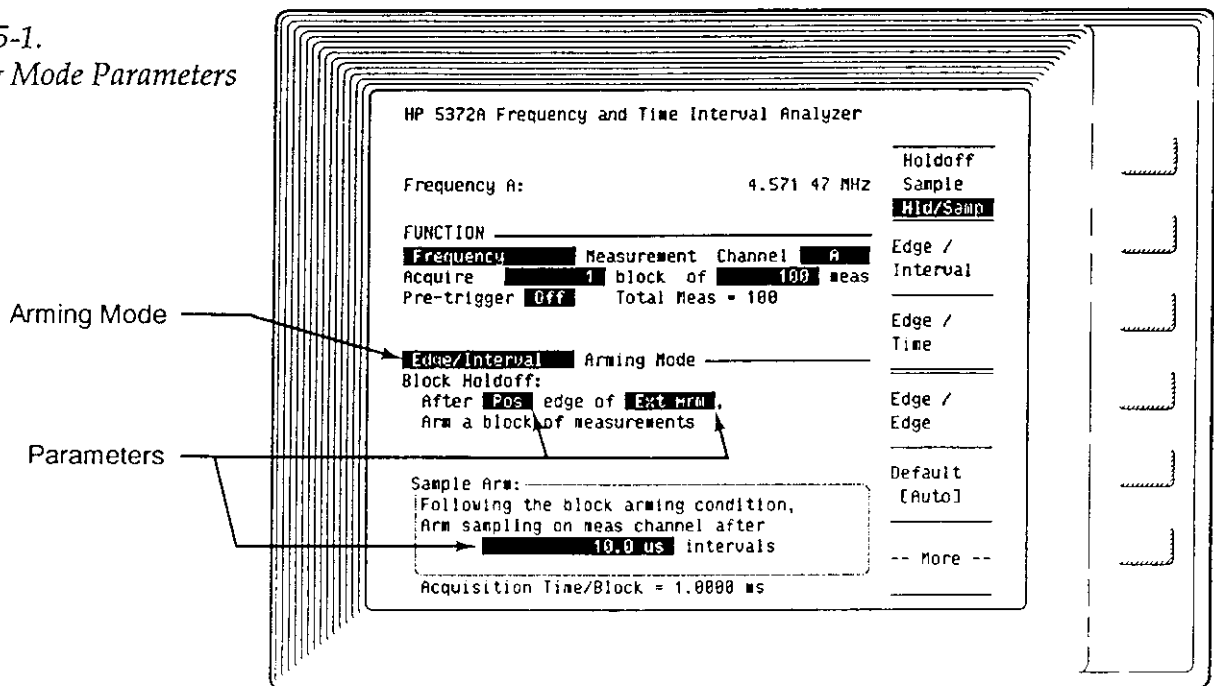

## Group vs. Individual Arming

The arming mode selected determines how measurements are acquired. The HP 5372A has two ways of acquiring measurements:

1. Measurements can be acquired in a group of contiguous measurements. This is called, "continuous arming."

OR

2. Measurements can be acquired separately. This is called, "non-continuous arming."

### TECHNICAL COMMENT

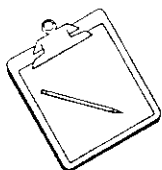

*There are several ways to know from the text on the menu screen whether the selected arming mode provides continuous or non-continuous arming. What follows shows two examples of how you can tell if your measurements will be acquired in a group, or individually.*

```

HP 5372A Frequency and Time Interval Analyzer

Frequency A:                4.577 75 MHz
Holdoff                      Sample
                             Hld/Samp

FUNCTION
Frequency Measurement Channel A Edge /
Acquire 1 block of 100 meas Interval
Pre-trigger Off Total Meas = 100

Edge / Interval Arming Mode
Block Holdoff:
After Pos edge of Chan A,
Arm a block of measurements

Edge / Time
Edge /
Edge

Sample Arm:
Following the block arming condition,
Arm sampling on meas channel after
10.0 us intervals

Default [Auto]
-- More --

Acquisition Time/Block = 1.0000 ms

```

*Measurements are acquired in a group. The group of measurements is called a "block." For example, 1 block of 100 measurements. The HP 5372A will make 100 measurements without stopping. This is an example of a continuous arming process.*

OR

```

HP 5372A Frequency and Time Interval Analyzer

Frequency A:                4.570 475 50 MHz
                                                                    Holdoff
                                                                    Sample
                                                                    Hld/Samp

FUNCTION _____
Frequency Measurement Channel A
Acquire 100 blocks of 1 meas
Pre-trigger Off Total Meas = 100
Display All Results from all blocks
Edge /
Interval

Edge/Time Arming Mode _____
Start Arm:
After Pos edge of Chan A,
Arm each measurement
Edge /
Edge

Stop Arm:
Default
[Auto]

Following the start arming edge
Delay 10.000000 us
Then arm the end of each measurement
-- More --
    
```

*Measurements will be collected one at a time. For example, 100 blocks of 1 measurement. Each measurement will have a discrete start and stop. This is an example of a non-continuous arming process.*

```

HP 5372A Frequency and Time Interval Analyzer

Frequency A:                219.0 ns
                                                                    Holdoff
                                                                    Sample
                                                                    Hld/Samp

FUNCTION _____
Time Interval Measurement Channel A
Acquire 1 block of 100 meas
Pre-trigger Off Total Meas = 100
Edge
Holdoff

Time Holdoff Arming Mode _____
Block Holdoff:
After Pos edge of Chan B,
Delay 500 ns
Then arm a block of measurements
Time
Holdoff

Event
Holdoff

Sample Arm:
Arm sampling on meas channel automatically
Default
[Auto]
    
```

*The term, "Block Holdoff," implies that there is some condition which must be satisfied before the Analyzer can begin to collect measurement samples. This is continuous arming.*

OR

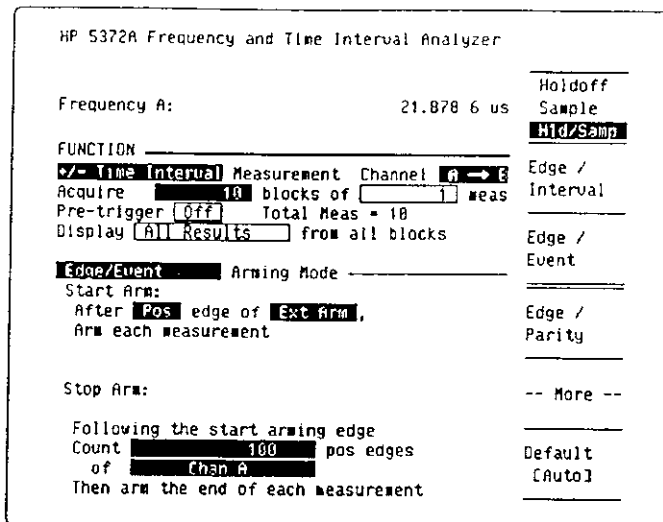

*The use of the two terms, "Start Arm and Stop Arm," is intended to communicate that the measurements are collected individually. Each measurement has a start condition and a stop condition. This is non-continuous arming.*

### Continuous and Non-continuous Arming

Figures 5-2 and 5-3 show a comparison of the the continuous and non-continuous arming process.

AN EXAMPLE OF CONTINUOUS ARMING

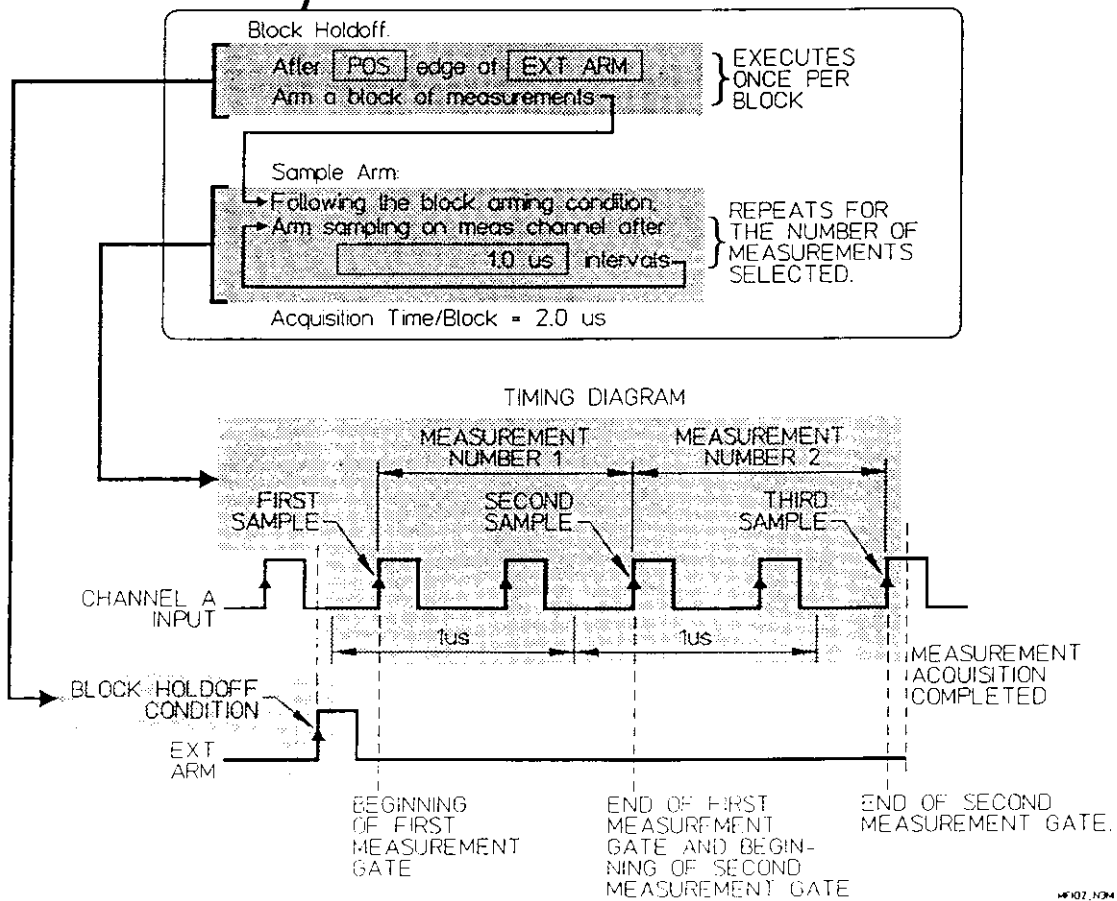
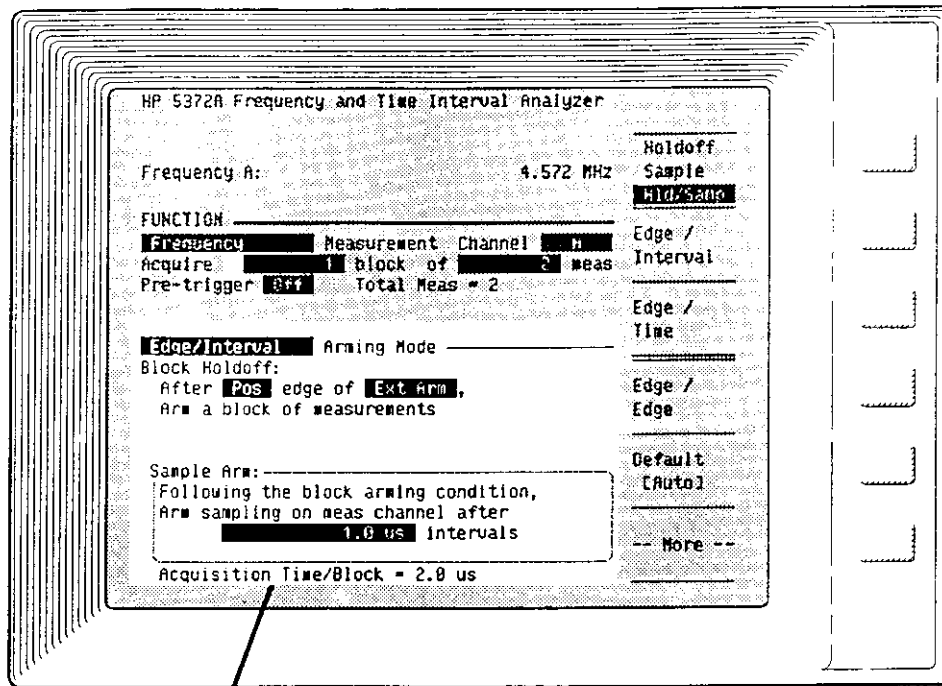

Figure 5-2. Group of Measurements

AN EXAMPLE OF NON-CONTINUOUS ARMING

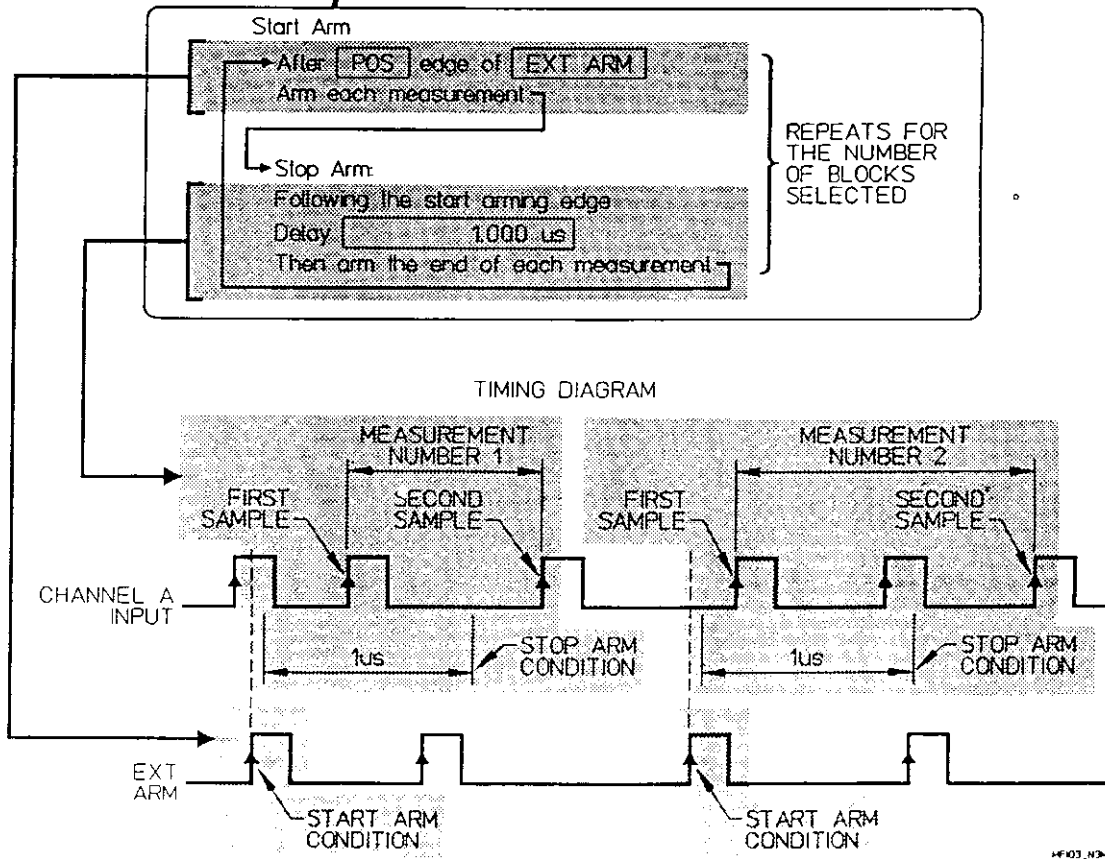
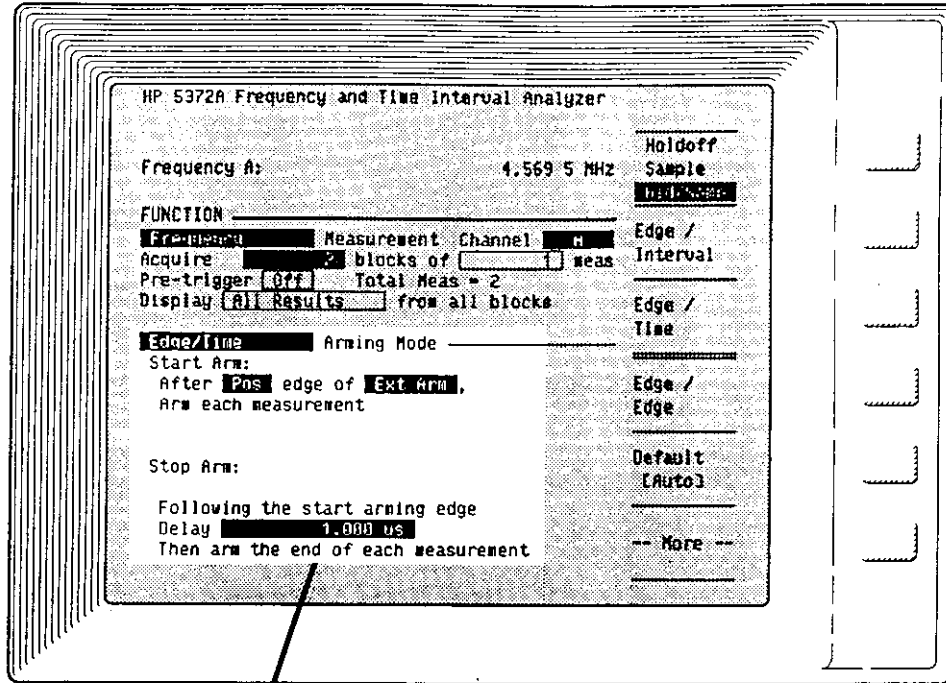

Figure 5-3. Separate Measurements

### Continuous or Non-Continuous?

The advantages of continuous arming are:

- A continuous “profile” of a signal’s variations and characteristics over time can be studied directly.
- The measurements are related to one another. That is, the time of each of the measurements, and the number of events that occurred during each measurement are known for the entire block of measurements.
- Typically, the measurement sequence executes faster than a non-continuous arming measurement.

### NOTE

---

*A measurement using a continuous arming mode can be made to acquire measurements non-continuously by specifying the measurement sequence as N blocks of 1 measurement.*

---

In most cases, you will probably want to use the continuous arming modes. However, non-continuous modes may be useful if:

1. The measurement application requires a single measurement made in a particular portion of a complex signal.
2. The required measurement rate exceeds the maximum measurement rate of the HP 5372A. If the signal is repetitive, multiple “passes” can be made over the signal. Arming modes can be used to “step” the measurement through the portion of interest.

### Arming Mode Categories

Arming modes specify collection of a sample in one of four ways:

1. Automatically
2. After an edge
3. After some time or “interval”
4. After a number of edges or “events”



Each of the arming modes uses one of these methods or a combination of two or more to allow the collection of samples at very specific points.

The 25 arming modes are grouped into four categories:

- Automatic (implies no holdoff and the fastest possible measurement pacing)
- Holdoff (implies fastest possible measurement pacing)
- Sampling (implies no holdoff)
- Holdoff/Sampling (you have control over both the block holdoff and the measurement pacing within the block of measurements)

Each category gives you a different level of control over the start of a measurement sequence and over how often measurement samples are collected. Your selection depends on your measurement application. Here is an overview of the four arming categories and the arming modes in each.

#### AUTOMATIC MODE

Choose the **AUTOMATIC** mode if you want the block of measurements to start as soon as possible, and you want the measurement samples collected as quickly as possible. The mode is:

- **AUTOMATIC** — A block of measurements starts as soon as the Analyzer is ready, and samples are collected as quickly as possible. (Continuous arming)

#### HOLDOFF MODES

Choose a **HOLDOFF** mode if you want to delay starting a block of measurements until a condition which you specify is met. Measurement samples are then collected as quickly as possible. The Holdoff modes are:

- **EDGE HOLDOFF** — A block of measurements is delayed until a specified edge is received. (Continuous arming)
- **TIME HOLDOFF** — A block is delayed until a specified edge followed by a specified time. (Continuous arming)
- **EVENT HOLDOFF** — A block is delayed until a specified edge followed by a specified number of events. (Continuous arming)

**SAMPLING MODES** With a **SAMPLING** mode, a block of measurements begins as soon as possible, but you specify how often a sample will be collected within a block of measurements. The Sampling modes are:

- **INTERVAL SAMPLING** — Specifies a time between samples. (Continuous arming)
- **TIME SAMPLING** — Similar to Interval Sampling, but the arming is non-continuous. The time between samples can be set with greater resolution. (Non-continuous arming)
- **CYCLE SAMPLING** — Specifies a constant number of events between samples. (Continuous arming)
- **EDGE SAMPLING** — Each sample taken after a specified edge. (Continuous arming)
- **PARITY SAMPLING** — Each measurement taken after an edge on both Channel A and B. (Continuous arming)
- **REPETITIVE EDGE** — Each sample taken after a specified edge. (Continuous arming)
- **REPETITIVE EDGE - PARITY** — Each measurement taken after a specified edge followed by an edge on both Channel A and B. (Continuous arming)
- **RANDOM SAMPLING** — Samples taken after a randomly selected number of events. (Continuous arming)

**HOLDOFF / SAMPLING  
MODES**

The **HOLDOFF/SAMPLING** mode combines both a delay of the measurement block start AND a specification of when each sample within the block will be collected. The Holdoff/Sampling modes are:

- **EDGE / INTERVAL** — The start of the block is delayed until a specified edge. Samples within the block are taken after a specified time. (Continuous arming)
- **EDGE / TIME** — The start of the measurement is delayed until a specified edge. The end of the measurement comes after a specified time. (Non-continuous arming)
- **EDGE / EDGE** — The start of the block is delayed until a specified edge. Each sample taken after a specified edge. (Continuous arming)

- **EDGE / CYCLE** — The start of the block is delayed until a specified edge. Samples taken after a specified number of events. (Continuous arming)
- **EDGE / EVENT** — The start of the measurement is delayed until a specified edge. The end of the measurement comes after a specified number of events. (Non-continuous arming)
- **EDGE / PARITY** — The start of the block is delayed until a specified edge. Each measurement taken after a specified edge on both Channel A and B. (Continuous arming)
- **EDGE / RANDOM** — The start of the block is delayed until a specified edge. Samples taken after a randomly selected number of events. (Continuous arming)
- **TIME / INTERVAL** — The start of the block is delayed until after a specified edge followed by a specified time. Samples taken after a specified time. (Continuous arming)
- **TIME / TIME** — The start of the measurement is delayed until after a specified edge followed by a specified time. The end of the measurement comes after a specified time. (Non-continuous arming)
- **EVENT / INTERVAL** — The start of the block is delayed until after a specified edge followed by a number of events. Samples taken after a specified time. (Continuous arming)
- **EVENT / EVENT** — The start of the measurement is delayed until after a specified edge followed by a number of events. The end of the the measurement comes after a specified number of events. (Non-continuous arming)
- **EXTERNALLY GATED** — The start of the measurement is taken after a leading edge of a positive or negative pulse. The measurement ends after the trailing edge of the pulse. (Continuous arming)
- **MANUAL** — Measurement starts when the Manual Arm key is pressed. Measurement ends when the Manual Arm key is pressed again. (Non-continuous arming)

## FUNCTION AND ARMING MODE SUMMARY

The following table summarizes the four groups of arming modes and the available arming modes for each function.

HP 5372A Function and Arming Summary

ARMING MODE	MEASUREMENT FUNCTION																		
	TIME INTERVAL OR HISTOGRAM TI		CONTINUOUS TIME INTERVAL OR HISTOGRAM CTI		± TIME INTERVAL OR HISTOGRAM ± TI		FREQUENCY, PERIOD		TOTALIZE		POS WIDTH	NEG WIDTH	RISE TIME	FALL TIME	DUTY CYCLE	PHASE	PEAK AMPLITUDE	PHASE DEVIATION	TIME DEVIATION
	A	A → B	A	A	A → B	A	DUAL <sup>1</sup>	A	DUAL <sup>1</sup>	A	A rel B	A	A	A	A	A	A	A	A
	B	B → A	B	B	B → A	B	RATIO <sup>2</sup>	B	RATIO <sup>2</sup>	B	B rel A	B	B	B	B	B	B	B	B
							C	SUM <sup>3</sup>	SUM <sup>3</sup>										
								DIFF <sup>4</sup>	DIFF <sup>4</sup>										
AUTOMATIC																			
AUTOMATIC	C*	C*	C*		C*	C*	C*				C*	C*	N*	C*	C*				
HOLDOFF																			
EDGE HOLDOFF	C	C	C		C	C					C					C			C
TIME HOLDOFF	C	C	C			C													
EVENT HOLDOFF	C	C	C			C													
SAMPLING																			
INTERVAL SAMPLING	C	C	C		C	C	C	C*	C*		C					C			C
TIME SAMPLING							N												
CYCLE SAMPLING							C												
EDGE SAMPLING							C	C	C	C									
PARITY SAMPLING							C												
REPET EDGE SAMPLING	C	C	C		C														
REPET EDGE-PARITY SAMPLING							C												
RANDOM SAMPLING	C	C			C														
HOLDOFF/SAMPLING																			
EDGE/INTERVAL	C	C	C		C	C	C	C	C		C					C			C
EDGE/TIME							N												
EDGE/EDGE							C		C	C									
EDGE/CYCLE							C												
EDGE/EVENT					N	N	N												
EDGE/PARITY						C													
EDGE/RANDOM	C	C			C														
TIME/INTERVAL							C		C										
TIME/TIME					N	N	N												
EVENT/INTERVAL							C												
EVENT/EVENT					N*	N	N												
EXTERNALLY GATED							C		C	C									
MANUAL									N	N									

Symbol C or N indicates that a measurement can be made using the corresponding combination of Function, Channel, and Arming functions.

C = Continuous Arming, (Block/Sample Arming)

N = Non-Continuous arming, (Start/Stop Arming), setups are limited to M blocks of 1 measurement.

1. DUAL. Simultaneous Dual-channel, (2 results). Frequency and Period options are: A&B, A&C, B&C. Totalize option is: A&B.

2. RATIO. Frequency and Period ratio options are: A/B, A/C, B/A, B/C, C/A, C/B. Totalize ratio options are: A/B, B/A.

3. SUM. Frequency and Period sum options are: A+B, A+C, B+C. Totalize sum option is: A+B.

4. DIFFERENCE. Frequency and Period difference options are: A-B, A-C, B-A, B-C, C-A, C-B. Totalize difference options are: A-B, B-A.

\* = Default Arming

*HP 5372A Function and Arming Summary (Continued)*

ARMING CATEGORIES

Category	Continuous Arming Modes	Non-Continuous Arming Modes
Automatic	Block Holdoff is Automatic Sample Arm is Automatic	none
Holdoff Modes	Block Holdoff is User-defined Sample Arm is Automatic	none
Sampling Modes	Block Holdoff is Automatic Sample Arm is User-defined	Start Arm is Automatic Stop Arm is User-defined
Holdoff/Sampling Modes	Block Holdoff is User-defined Sample Arm is User-defined	Start Arm is User-defined Stop Arm is User-defined

### Where Arming Fits In

Selection of the appropriate arming mode is an important element in preparing the HP 5372A to make a measurement. This short review of a measurement setup shows where arming fits in. A chirped radar pulse in Figure 5-4 is used to illustrate how the measurement would be made.

A measurement setup includes the following:

1. Select the measurement function on the Function menu.

*An example is: Frequency measurement on Channel A.*

2. Specify the number of measurements in the measurement sequence on the Function menu.

*An example is: 1 block of 100 measurements.*

3. Select an arming mode on the Function menu.

*An example is: Edge/Interval.*

The edge is specified as a positive slope on Ext Arm. The interval is specified as 100 ns.

This arming mode delays the start of a block of measurements until a positive edge occurs at the External Arm input, and then samples are collected after a specified time interval.

4. Specify the trigger event on the Input menu.

*An example is: Positive slope of the signal at Channel A at 0 volts.*

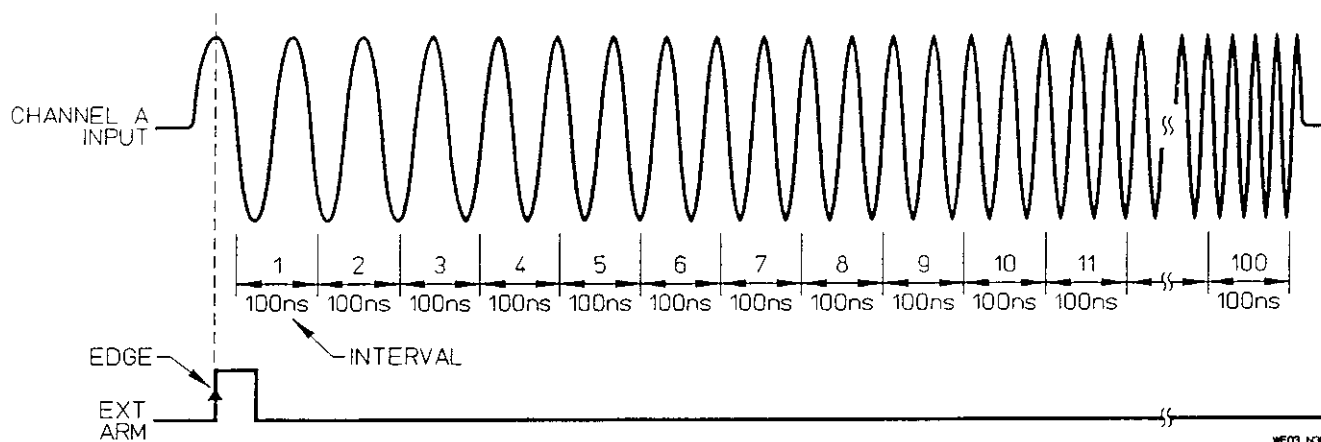

Figure 5-4. Edge/Interval Arming Example

## ARMING SCREEN TERMS

You select the arming mode and specify its parameters on the Function menu. Text is used on the arming portion of the screen in a sentence-like structure to assist you in specifying how and when you want your measurement samples to be collected. There is a lot of flexibility in how an arming setup can be configured.

Some examples are included here to introduce the context in which the terms are used. Once you understand the terms, you will realize the power of the HP 5372A to make your measurement.

Following this section is a detailed description of each of the arming modes. It includes all the arming mode parameters. Use it as a reference to obtain detailed information about how a particular arming mode operates. Refer to the measurement chapters (1,2,3,4) for the exact ranges of arming mode parameters for every measurement and arming mode combination.

### **NOTE**

---

*Consult the appropriate chapter describing your measurement to see how the measurement data is collected. The arming examples in this chapter are intended to demonstrate the arming mode, not how a particular type of measurement is made. Some subtleties of specific measurement types may not be seen here.*

---

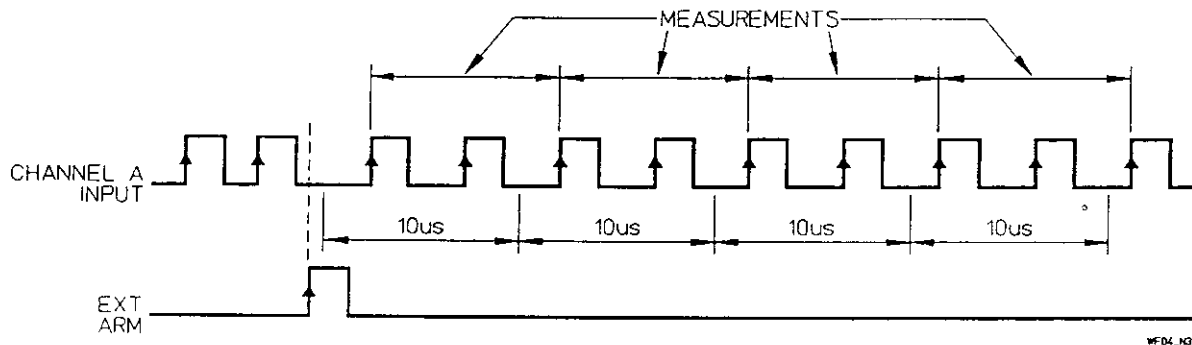
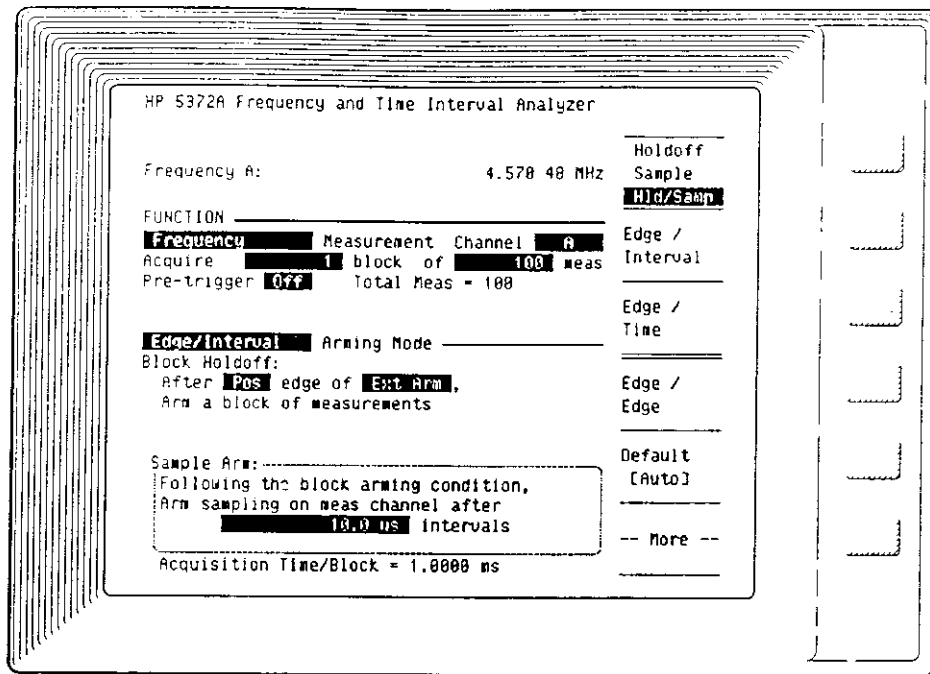

Figure 5-5. Continuous Arming Phrases

Arming Menu Phrases from Figure 5-5:

- **Block Holdoff** — The specified condition, or conditions, which must occur before a block of measurements can begin.
- **Arm a block of measurements** — The HP 5372A is ready to begin the first measurement of a block after the block holdoff occurs. The first measurement begins (that is, the first sample is captured) at the next trigger event on the measurement channel.



- **Sample Arm** — The specified condition that must occur before each measurement sample can be captured within the block of measurements.
- **Following the block arming condition** — Once the block arm condition occurs, the sample arm condition can then execute. The sample arm condition cannot occur until after the block arm condition is satisfied.
- **Arm sampling on meas channel** — The HP 5372A is ready to capture a measurement sample after the sample arm occurs. A sample is captured at the next trigger event on the measurement channel.
- **intervals** — A repetitive time period that sets the time between measurement samples.

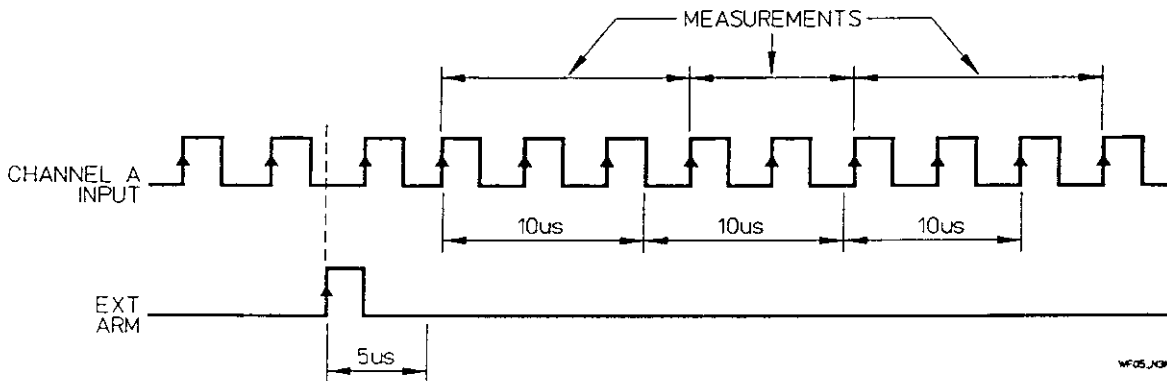
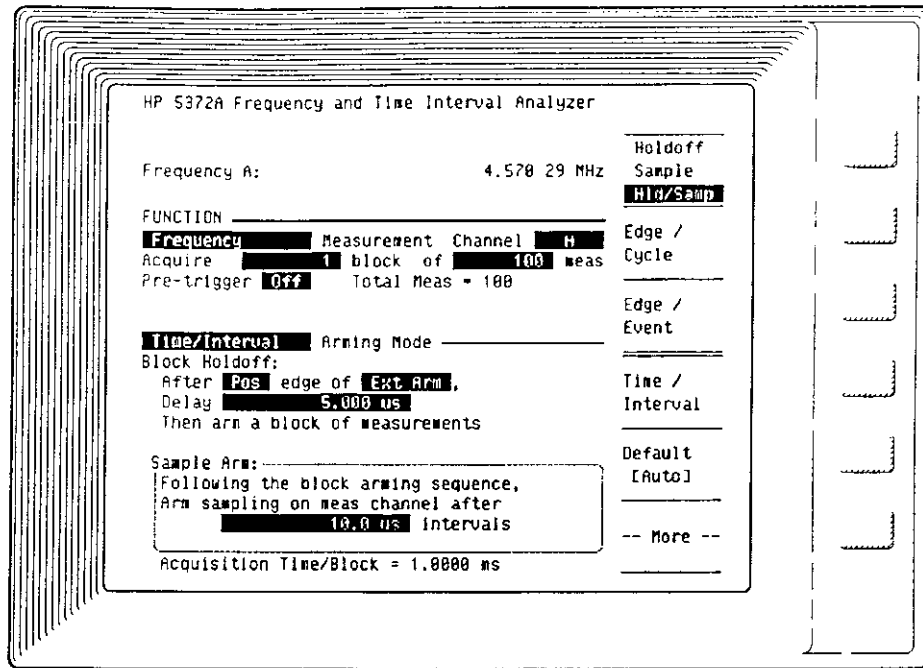

Figure 5-6. More Continuous Arming Phrases

Arming Menu Phrase from Figure 5-6:

- Following the block arming sequence — “Block arming sequence” refers to a two-stage block holdoff. The conditions are: an edge plus some time or an edge plus a number of events. Once the block arm conditions occur, the sample arm condition can then execute. The sample arm condition cannot occur until after the block arm conditions are satisfied.

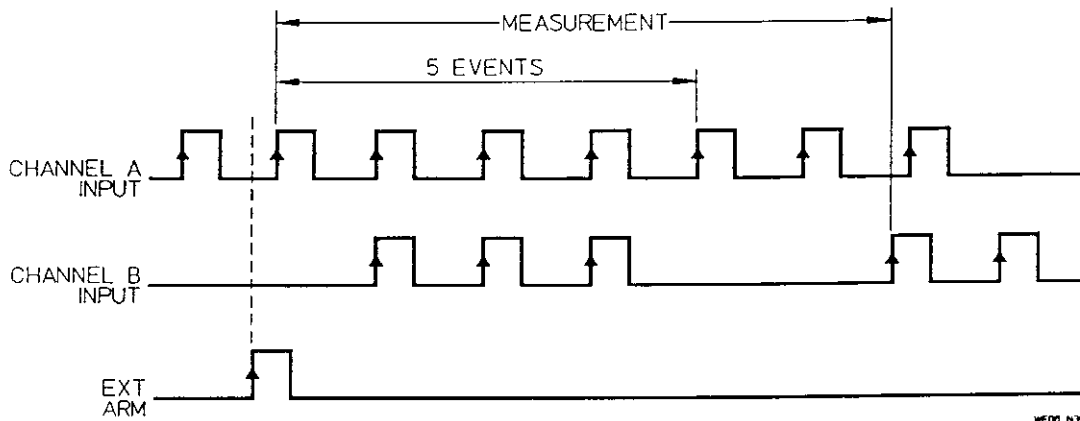
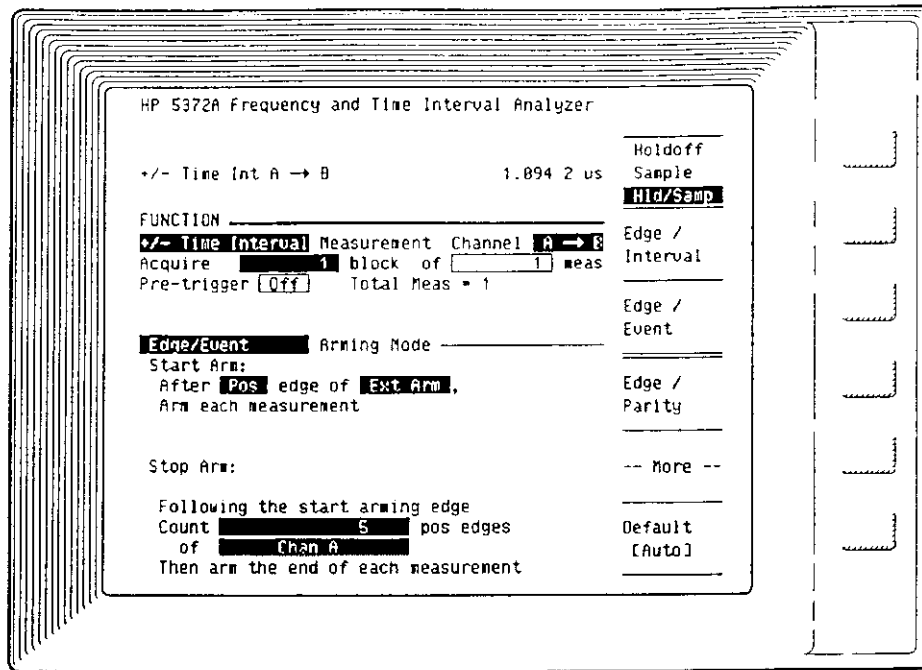

Figure 5-7. Non-continuous Arming Phrases

#### Arming Menu Phrases from Figure 5-7:

- **Start Arm** — The specified condition which must occur before a sample can be captured to begin a measurement.
- **Arm each measurement** — The HP 5372A is ready to capture a sample after the start arm occurs. A sample is captured at the next trigger event on the measurement channel.

- **Stop Arm** — The specified condition which must occur before a sample can be captured to end a measurement.
- **Following the start arming edge** — Once the start arm edge occurs, the stop arm condition can then execute. The stop arm condition cannot occur until after the start arm edge condition is satisfied.
- **Count (events)** — Specifies how many events (edges on the input A, B, or External Arm) should be counted before the HP 5372A is ready to capture a sample on the measurement channel.
- **arm the end of each measurement** — The HP 5372A is ready to capture a sample after the stop arm occurs. The sample is captured at the next trigger event on the measurement channel to end the measurement.

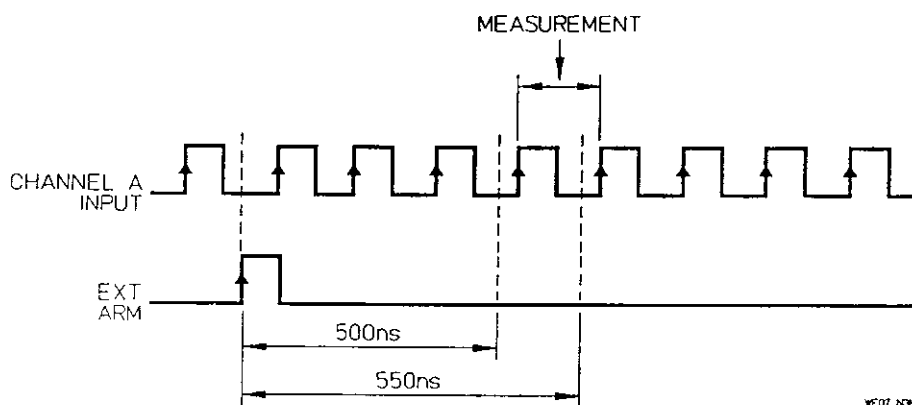
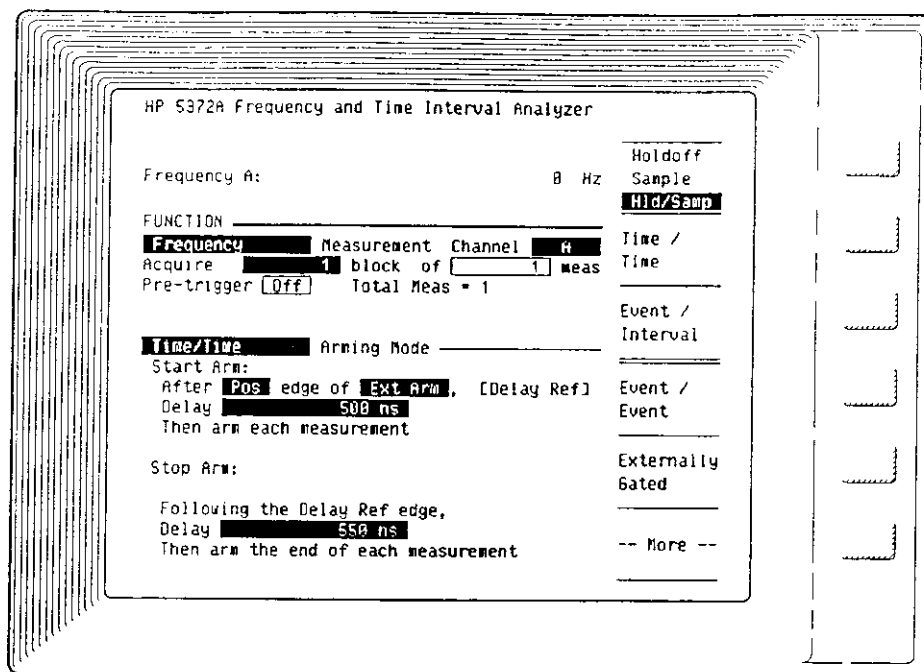

Figure 5-8. More Non-continuous Arming Phrases

#### Arming Menu Phrases from Figure 5-8:

- **[Delay Ref]** — A label for the delay reference edge. The delay being a delay of a specified time or number of events. In this example, the delay reference edge is a positive edge on External Arm.
- **Delay (time or events)** — Specifies how long the HP 5372A will wait before it is ready to capture a sample on the measurement channel.

- **Following the Delay Ref edge** — Once the delay reference edge occurs, the stop arm condition can execute. The stop arm condition cannot occur until after the delay reference edge.

## DETAILED ARMING MODE DESCRIPTIONS

The following pages contain a detailed description of each arming mode. Included for each mode is information on:

- Measurement functions which can be used in each arming mode
- How the measurement is armed
- Block Holdoff / Sample Arm
- Start Arm / Stop Arm
- Function menu setup screens
- Timing diagrams

Refer to the measurement chapters (1,2,3,4) for the specific limits on measurement functions and arming modes.

## Measurements Referenced To The Block Arming Edge

There are eight arming modes that can reference all measurements of a block to the block holdoff arming edge. They are:

- Edge Holdoff
- Time Holdoff
- Event Holdoff
- Edge / Interval
- Edge / Edge
- Edge / Cycle
- Time / Interval
- Event / Interval

For these arming modes, the edge which arms each block is "time-stamped," and the elapsed time between the block arming edge and the first measurement sample is measured.

This feature is not available for all measurement functions using these arming modes. Consult the arming mode descriptions that follow to find if the time value for the block arming edge is supported for your particular measurement.

While all the arming modes provide the time from the beginning of the first measurement of a block, these time-stamp arming modes also provide the time between the block arming edge and the first measurement sample that is collected. The time value is displayed on the Numeric screen. It is listed before the first measurement result of the block and has a "T" in front of it. The diagrams in the next part of this chapter show the time-stamp arming modes with a portion of the example signal labeled with a "T", where the example includes a measurement function for which this feature is available.

### **Averaged Results**

The feature of time-stamping the block arming edge makes it possible for the HP 5372A to average multiple blocks of measurements. When you select a measurement function and arming mode that support averaging, a field on the Function menu will allow selection of "Averaged Results" (the other option is "All Results"). The averaged results are shown on the Numeric screen, the Time Variation and Event Timing graphs. If the total number of measurements selected exceeds the size of internal memory, "Averaged Results" is the only option available.

**AUTOMATIC MODE DESCRIPTION:**

This arming mode allows measurements to start as soon as the HP 5372A is ready. There is no external delay before measurements begin, and the sampling is determined by the input signal and the particular measurement being made. (Rise Time/Fall Time, Positive/Negative Pulse Width, and Duty Cycle measurements require some time to do the peak-to-peak amplitude measurements necessary before each measurement.)

Figure 5-9.  
AUTOMATIC  
Menu Screen

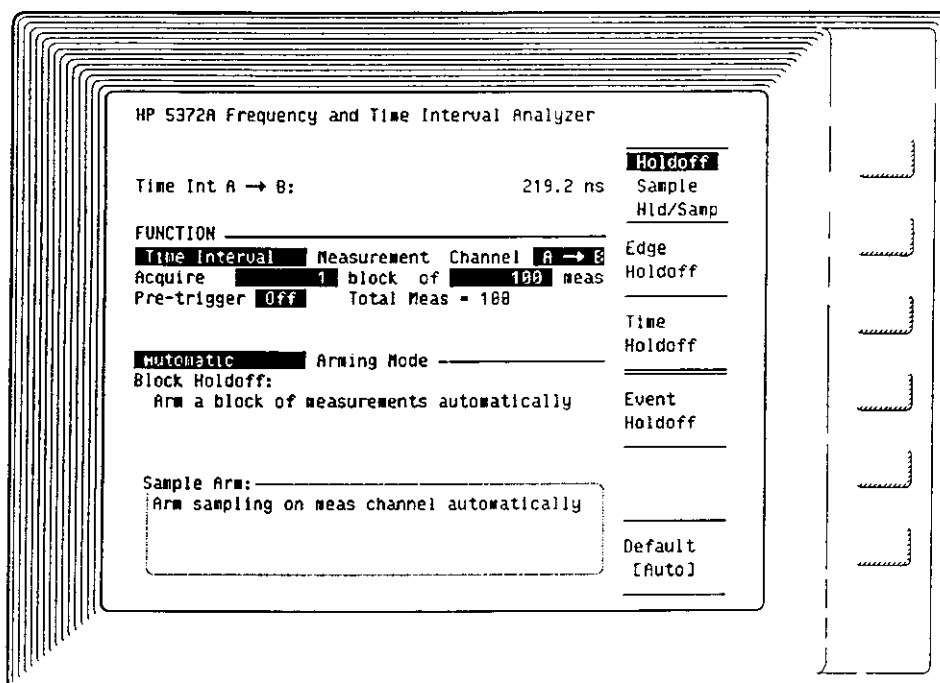

MEASUREMENTS: Time Interval, Continuous Time Interval, ± Time Interval, Frequency, Period, Phase, Phase Deviation, and Time Deviation

ARMING: Continuous

BLOCK HOLDOFF: Automatic

SAMPLE ARM: Automatic



COMMENTS: Automatic arming takes samples as quickly as possible. For signals > 10 MHz, Frequency, Period, and Continuous Time Interval measurements will occur every 100 ns (75 ns for Fast measurement mode, see "System Menu," chapter 12). For signals < 10 MHz, the measurement intervals are determined by the period of the signal being measured. For example, a 1 kHz signal measured with Automatic will cause the HP 5372A to sample every 1 ms. That is as fast as possible for the situation.

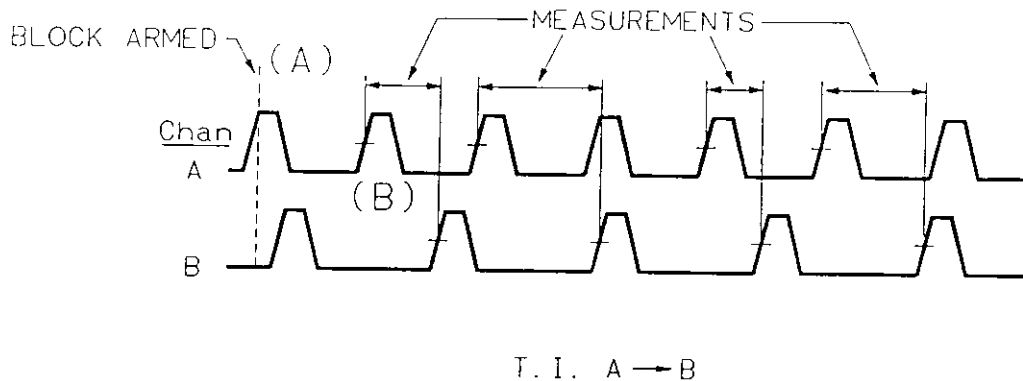

Figure 5-10. AUTOMATIC Timing Diagram

- (A) Block of measurements is automatically armed as soon as the Analyzer is ready.
- (B) Measurements begin on the next trigger event of Channel A.

**HOLDOFF MODES**      DESCRIPTION:

This arming group allows measurements to be held off, or delayed, until:

- **EDGE:** A signal edge on a selected input channel.
- **TIME:** A time period elapses after an edge.
- **EVENT:** A number of events are counted after an edge.

**Edge Holdoff**

Figure 5-11.  
EDGE HOLDOFF  
Menu Screen

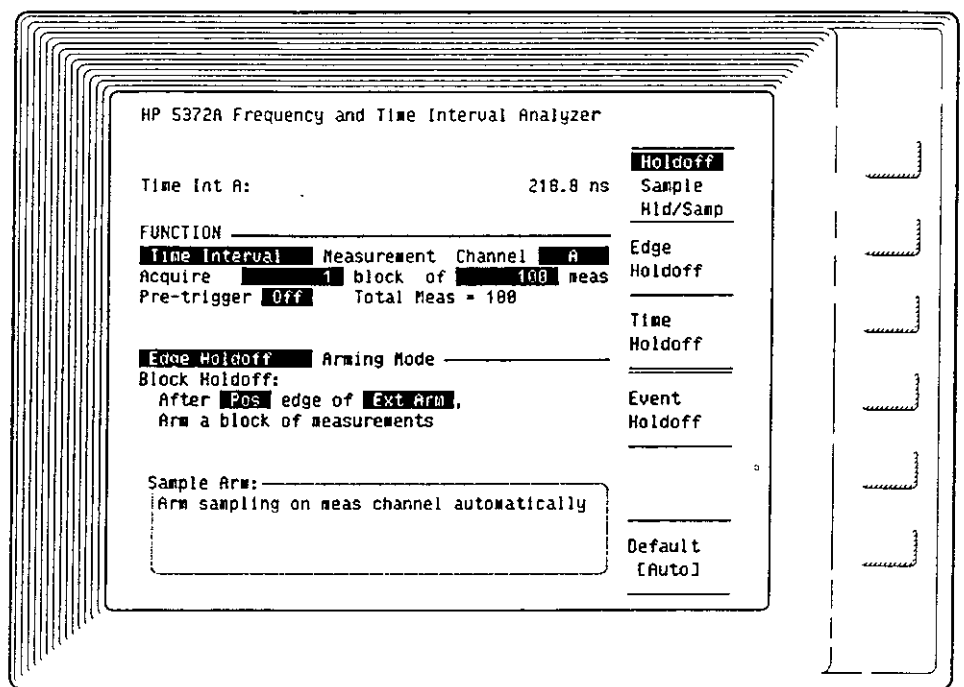

**MEASUREMENTS:** Time Interval, Continuous Time Interval, ± Time Interval, Frequency, Period, Phase, Phase Deviation, and Time Deviation

**ARMING:** Continuous

**BLOCK HOLDOFF:** Edge on Channel A, B, or Ext Arm

**SAMPLE ARM:** Automatic

**COMMENTS:** The reference edge is time stamped for Frequency, Period, Continuous Time Interval, Phase Deviation, and Time Deviation measurements.

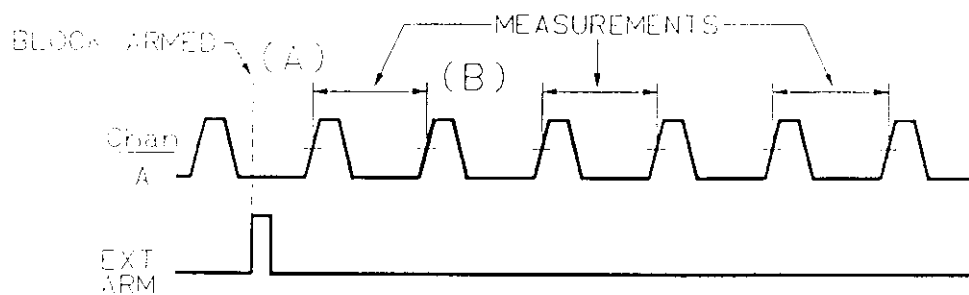

T. I. A

WF58\_02

Figure 5-12. EDGE HOLDOFF Timing Diagram

- (A) Block of measurements is armed by a positive edge on Ext Arm.
- (B) Measurements are taken on the trigger event of Channel A.

## Time Holdoff

Figure 5-13.  
TIME HOLDOFF  
Menu Screen

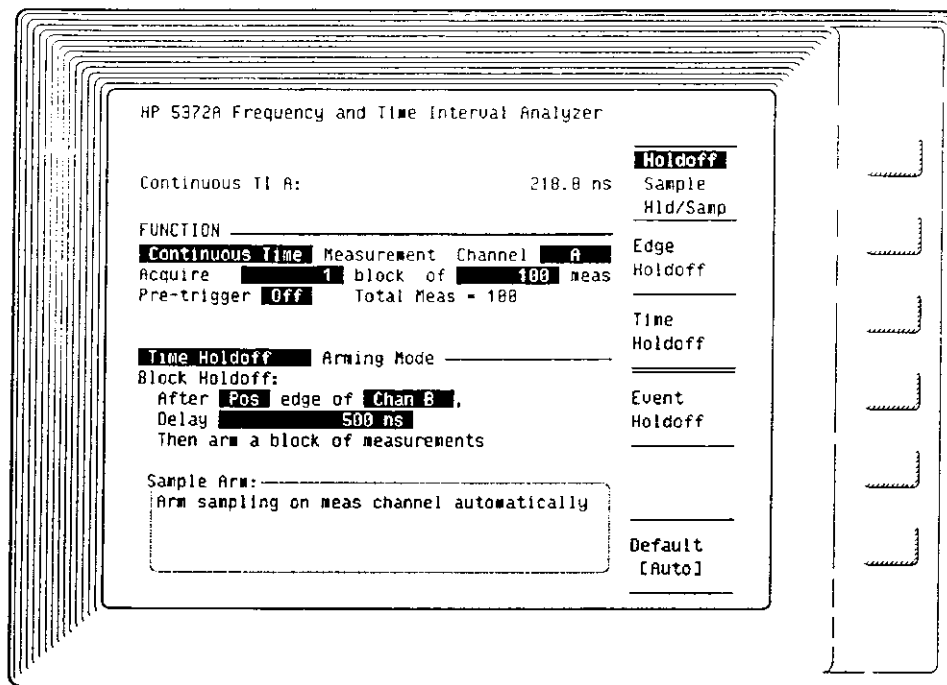

**MEASUREMENTS:** Time Interval, Continuous Time Interval, Frequency, and Period

**ARMING:** Continuous

**BLOCK HOLDOFF:** Time referenced to an edge on Channel A, B, or Ext Arm

**SAMPLE ARM:** Automatic

**COMMENTS:** The reference edge is time stamped for Frequency, Period, and Continuous Time Interval measurements.

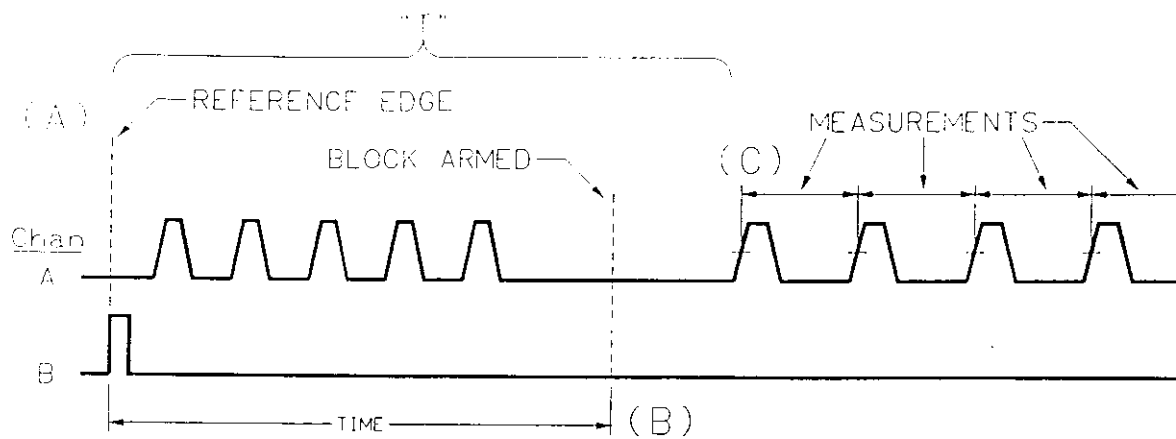

CONTINUOUS T. I. A

WF59\_N3

Figure 5-14. TIME HOLDOFF Timing Diagram

- (A) A positive edge of Channel B provides the reference edge for the time delay.
- (B) Block of measurements is armed at the end of the time delay.
- (C) Measurements are taken on the trigger event of Channel A.

## Event Holdoff

Figure 5-15.  
EVENT HOLDOFF  
Menu Screen

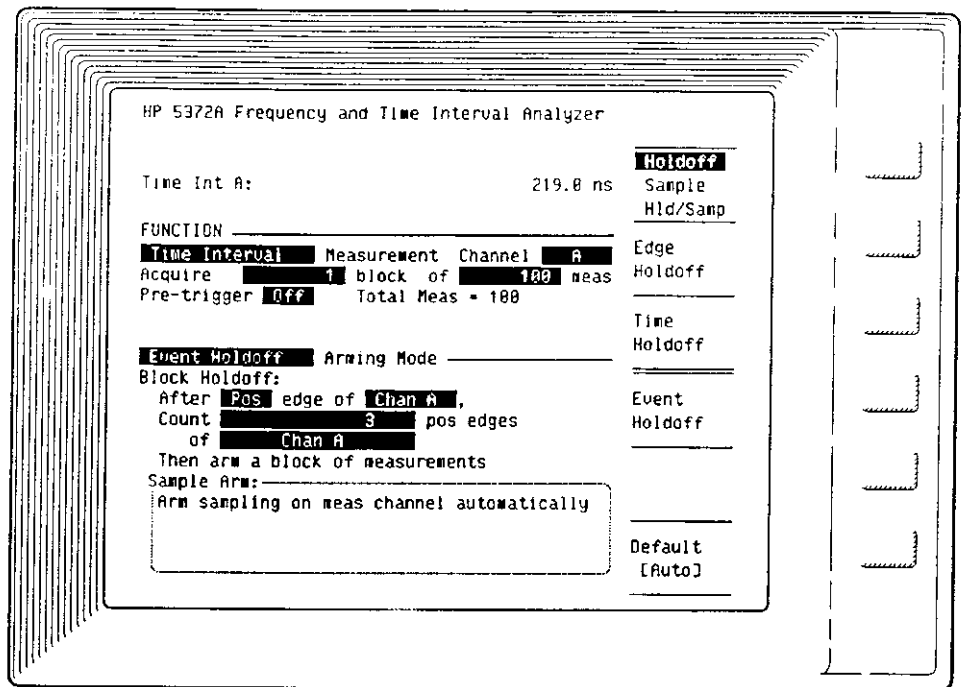

**MEASUREMENTS:** Time Interval, Continuous Time Interval, Frequency, and Period

**ARMING:** Continuous

**BLOCK HOLDOFF:** Events on Channel A or B referenced to an edge on Channel A, B, or Ext Arm

**SAMPLE ARM:** Automatic

**COMMENTS:** The reference edge is time stamped for Frequency, Period, and Continuous Time Interval measurements.

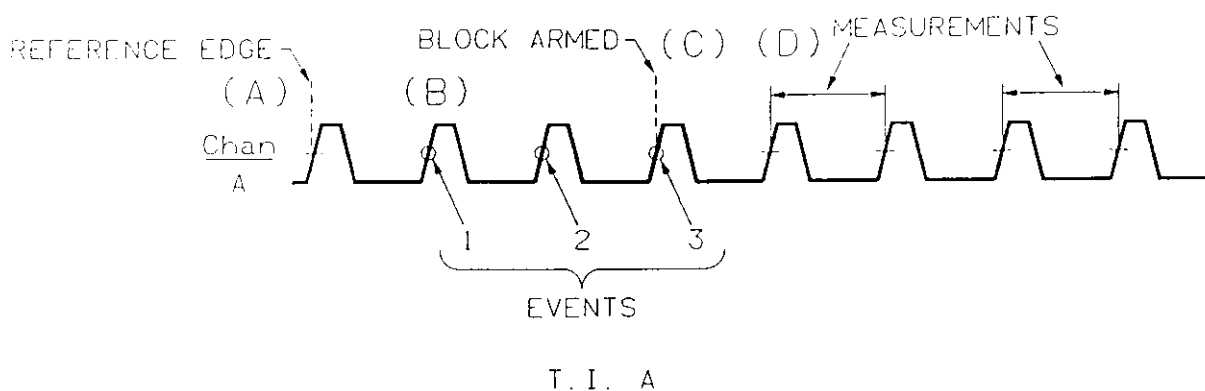

WF60\_N3

Figure 5-16. EVENT HOLDOFF Timing Diagram

- (A) A positive edge of Channel A provides the reference edge for the event delay.
- (B) The holdoff events begin on the trigger event of Channel A after the reference edge.
- (C) Block of measurements is armed after three events are counted.
- (D) Measurements are taken on the trigger event of Channel A.

## SAMPLING MODE

### Description:

This arming group allows blocks of measurements to start as soon as the HP 5372A is ready. There is no external delay before measurements begin. The sampling can then take place after:

- Interval: A repetitive time period
- Time: A higher resolution, non-continuous time period (2 ns resolution)
- Cycle: A predetermined number of events (cycles).
- Edge: A designated edge for Frequency, Period, and Totalize measurements.
- Parity: A trigger event on each of the two measurement channels. ( $\pm$  Time Interval only)
- Repetitive Edge: A designated edge for Time Interval measurements.

- Repetitive Edge-Parity: A designated edge and a trigger event on each of the two measurement channels. ( $\pm$  Time Interval only)
- Random: A random number of edges on Channel A between measurements.

## Interval Sampling

Figure 5-17.  
INTERVAL SAMPLING  
Menu Screen

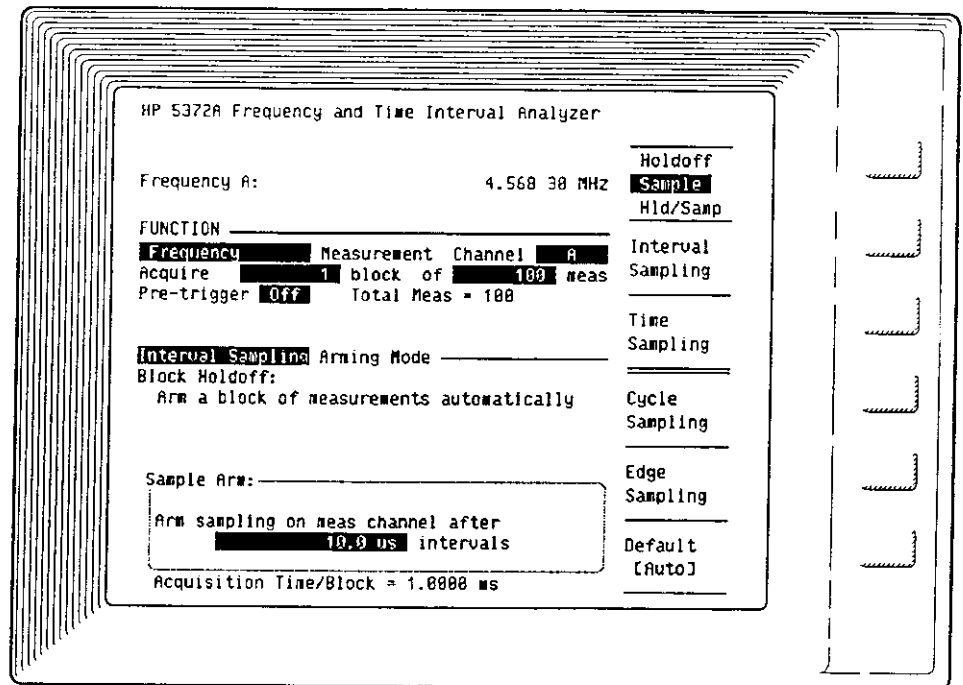

MEASUREMENTS: Time Interval, Continuous Time Interval,  $\pm$  Time Interval, Frequency, Period, Totalize, Phase, Phase Deviation, and Time Deviation

ARMING: Continuous

BLOCK HOLDOFF: Automatic

SAMPLE ARM: Interval referenced to the automatic block holdoff signal

COMMENTS: Sampling takes place on the trigger event following the set time interval.



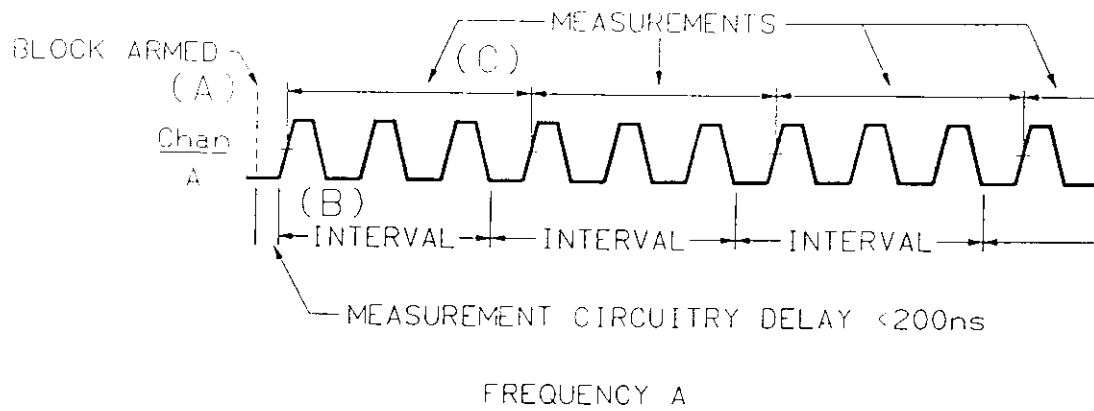

WF61\_N3

Figure 5-18. INTERVAL SAMPLING Timing Diagram

- (A) Block of measurements is armed as soon as the Analyzer is ready.
- (B) The first specified interval then begins after the internal circuitry delay.
- (C) The first measurement ends on the trigger event following the end of the first interval.

## Time Sampling

Figure 5-19.  
TIME SAMPLING  
Menu Screen

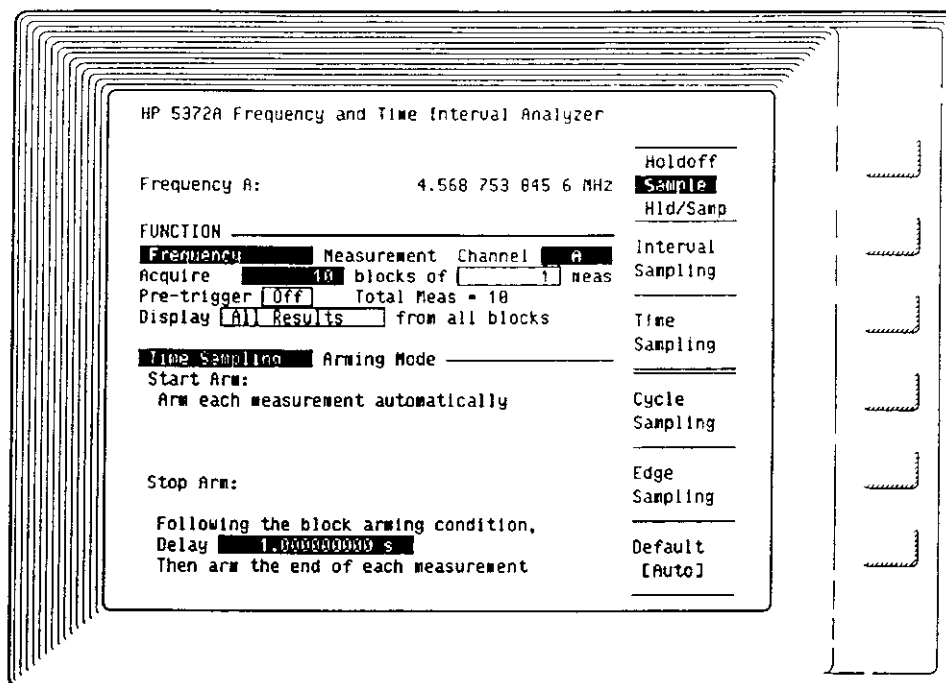

MEASUREMENTS: Frequency and Period

ARMING: Non-continuous

START ARM: Automatic

STOP ARM: Time referenced to the automatic start arm signal.

COMMENTS: Each measurement ends on the trigger event following the set time. Use this mode if you want to make "individual" Frequency or Period measurements. The arming is non-continuous, but the time can be specified with a 2 ns resolution. Use Interval Sampling for continuous measurements (multiple measurements in a block). Interval Sampling offers an interval resolution of 100 ns.

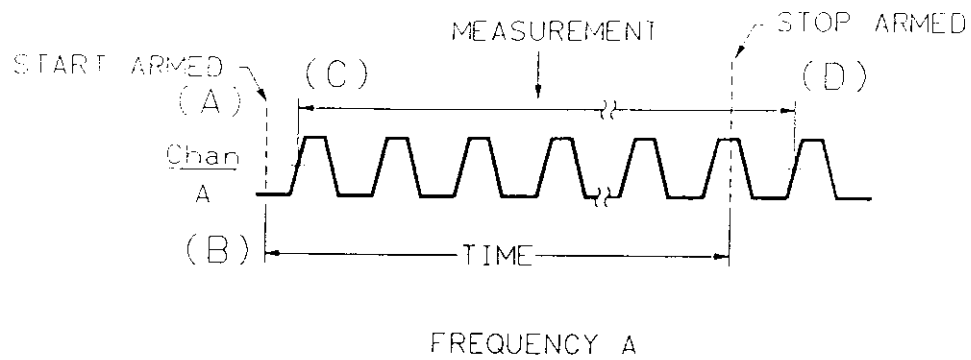

WF62\_N3

Figure 5-20. TIME SAMPLING Timing Diagram

- (A) Measurement start is armed as soon as the Analyzer is ready.
- (B) The time period is referenced to the arming signal.
- (C) The measurement starts on the trigger event of Channel A following the arming signal.
- (D) The measurement ends on the trigger event of Channel A after the time period ends.

## Cycle Sampling

Figure 5-21.  
CYCLE SAMPLING  
Menu Screen

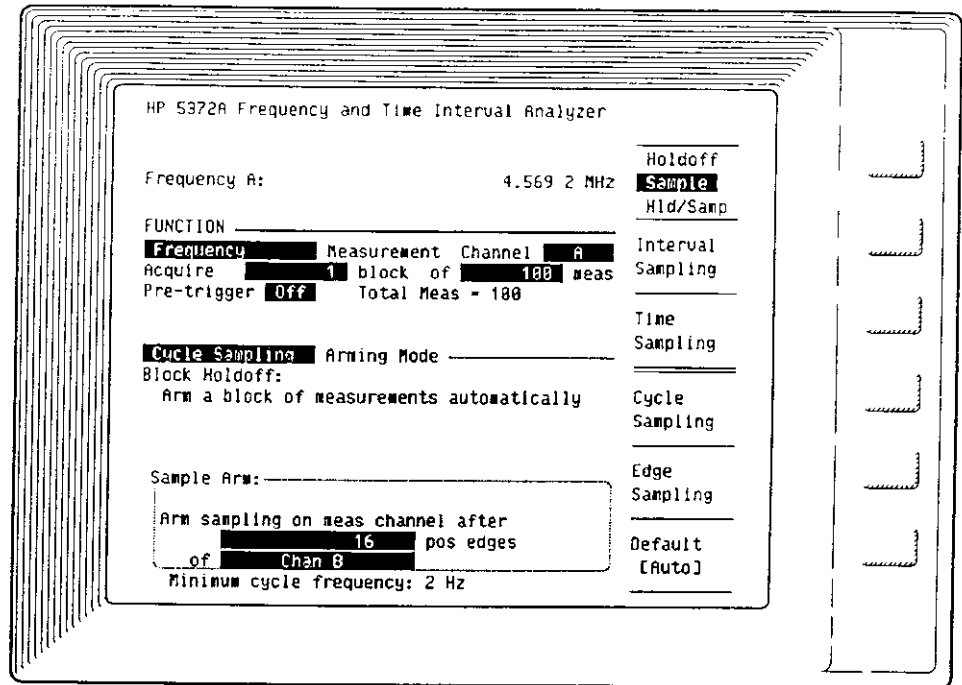

**MEASUREMENTS:** Frequency and Period

**ARMING:** Continuous

**BLOCK HOLDOFF:** Automatic

**SAMPLE ARM:** Cycles (events) of Channel A, B, or internal time base referenced to the automatic block holdoff signal.

**COMMENTS:** Sampling takes place on the trigger event following the counting of the selected number of cycle events. If the input frequency is below the minimum cycle frequency, as shown on the Cycle arming mode screen, measurement results will be incorrect.

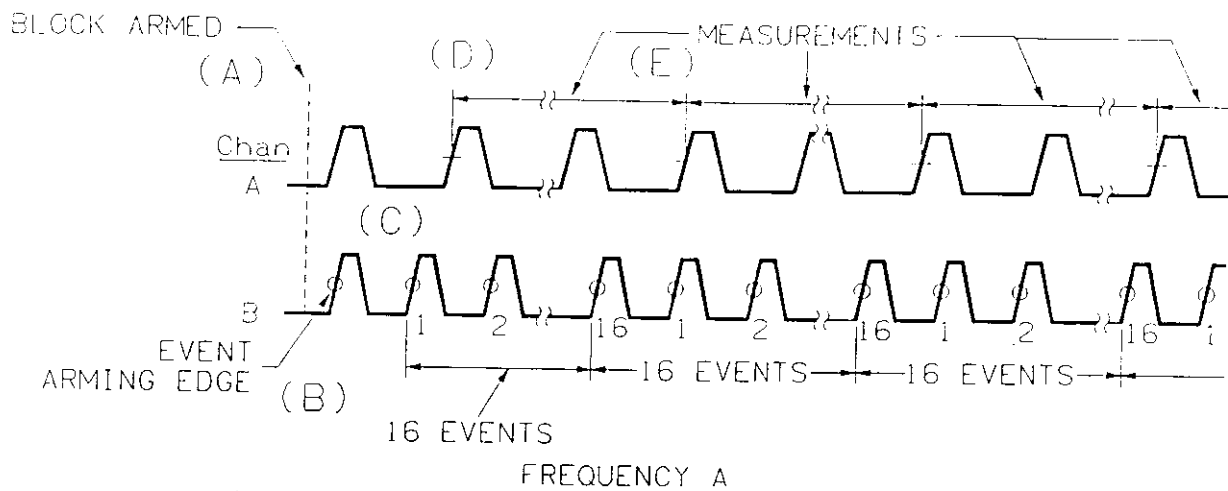

WF 63\_N3

Figure 5-22. CYCLE SAMPLING Timing Diagram

- (A) Block of measurements is armed as soon as the Analyzer is ready.
- (B) The event arming edge on the cycle channel arms the start of the first measurement and the counting of cycles on the cycle channel. If Channel A was the measurement channel and the cycle channel, the first measurement and the cycle count would both begin on the first trigger event of Channel A, after the event arming edge.
- (C) The counting of cycles begins on the next trigger event of the cycle channel, after the event arming edge.
- (D) The first measurement starts on the next trigger event on Channel A, after the event arming edge.
- (E) The measurement ends on the Channel A trigger event after 16 events are counted on the cycle channel. Following measurement samples are taken on the trigger events after each 16 events on the cycle channel.

## Edge Sampling

Figure 5-23.  
EDGE SAMPLING  
Menu Screen

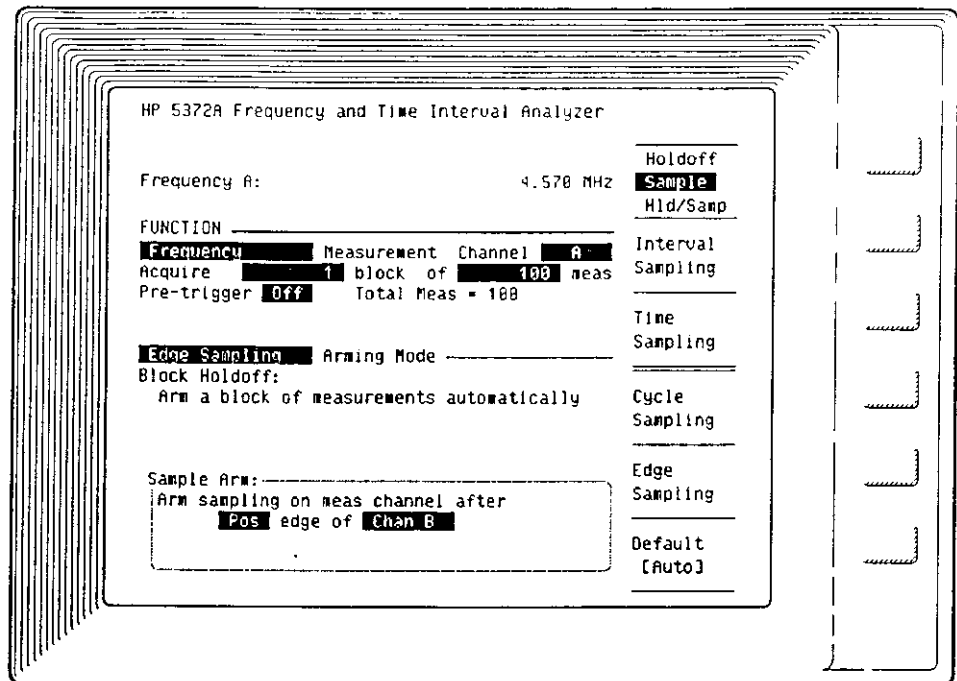

MEASUREMENTS: Frequency, Period, and Totalize

ARMING: Continuous

BLOCK HOLDOFF: Automatic

SAMPLE ARM: Edge on Channel A, B, or Ext Arm

COMMENTS: Sampling takes place on the trigger event following the designated edge.

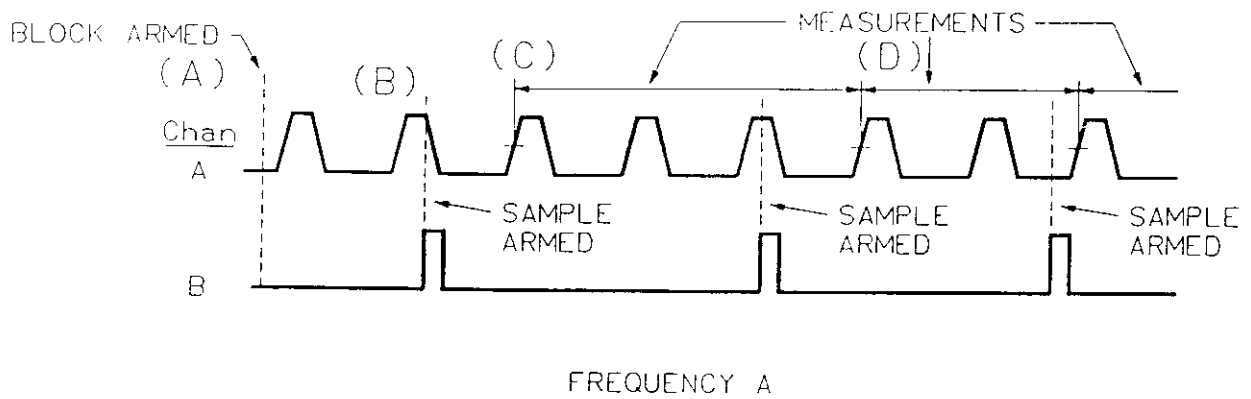

WF64\_N3

Figure 5-24. EDGE SAMPLING Timing Diagram

- (A) Block of measurements is armed as soon as the Analyzer is ready.
- (B) A positive edge on Channel B arms the start of the first measurement.
- (C) First measurement starts on the trigger event on Channel A following the arming edge.
- (D) First measurement ends on the Channel A trigger event following another positive edge on Channel B. Each of the following Channel B sample arming edges prepares the Analyzer to end a measurement on the next Channel A trigger event.

## Parity Sampling

Figure 5-25.  
PARITY SAMPLING  
Menu Screen

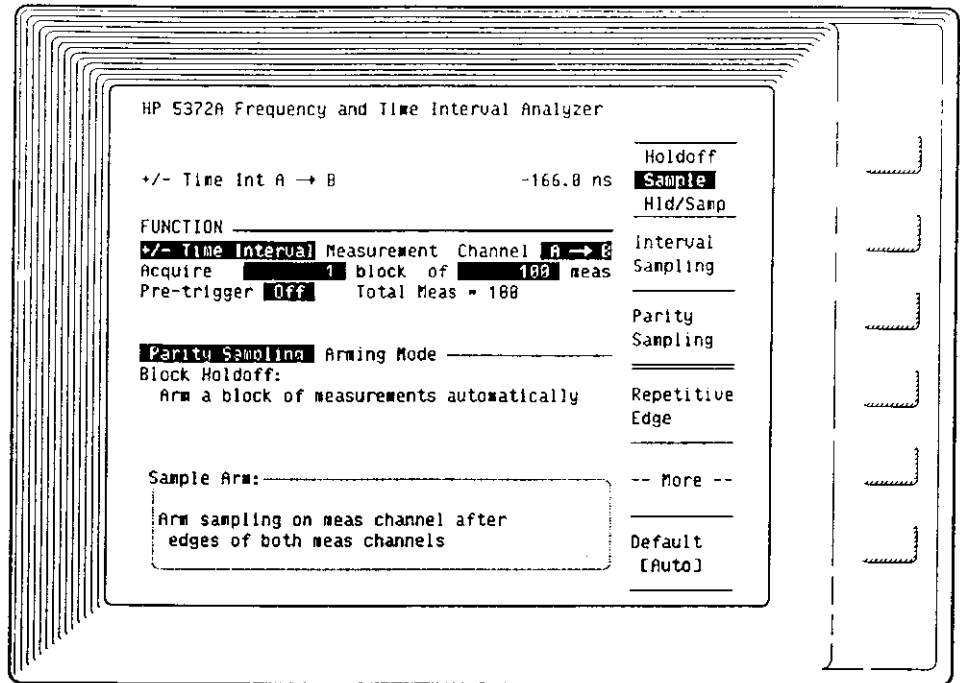

MEASUREMENT: ± Time Interval (two-channel)

ARMING: Continuous

BLOCK HOLDOFF: Automatic

SAMPLE ARM: Parity (An arming edge on Channel A and B)

COMMENTS: After an edge on each of two channels, a measurement is made. This arming mode is useful for applications where it is important to maintain a certain sequence for the two edges you are measuring. For example, you want to measure time intervals between two edges that lead and follow one another randomly.



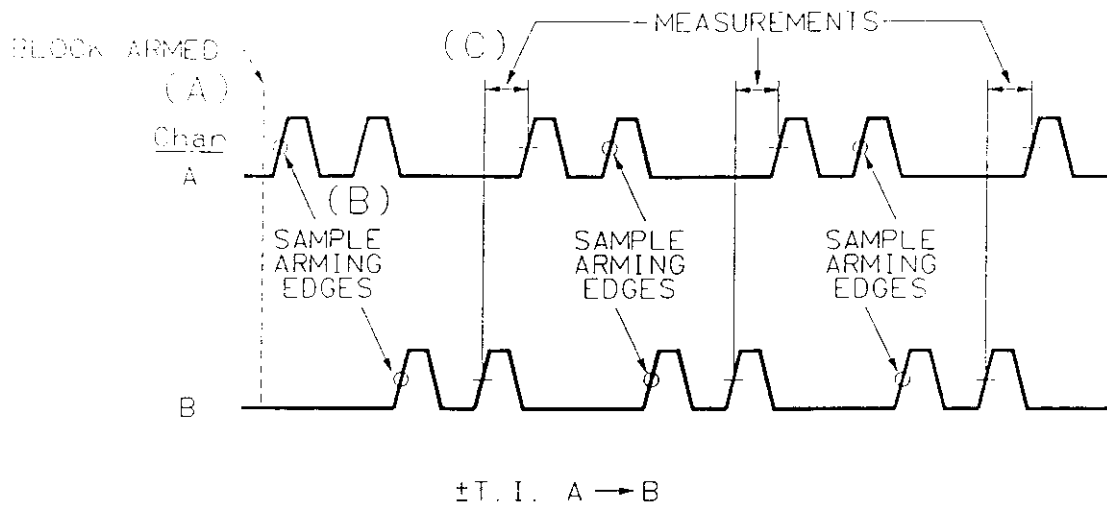

WF66\_N3

Figure 5-26. PARITY SAMPLING Timing Diagram

- (A) Block of measurements is armed as soon as the Analyzer is ready.
- (B) A trigger event on both Channel A and B is required before a measurement can be acquired.
- (C) After the sample arm requirement of a trigger event on each of the measurement channels, a measurement is taken on the next pair of Channel A and B trigger events. The sequence of (B) and (C) is repeated for each measurement.

## Repetitive Edge

Figure 5-27.  
REPETITIVE EDGE  
Menu Screen

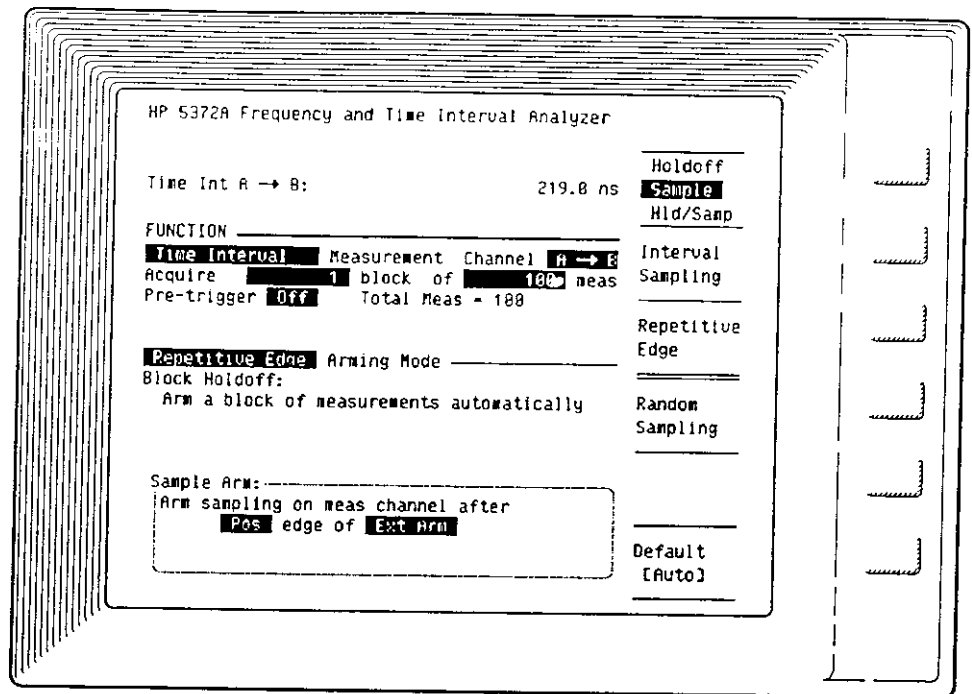

MEASUREMENTS: Time Interval, Continuous Time Interval, and ± Time Interval

ARMING: Continuous

BLOCK HOLDOFF: Automatic

SAMPLE ARM: An edge on Channel A, B, or Ext Arm before every sample

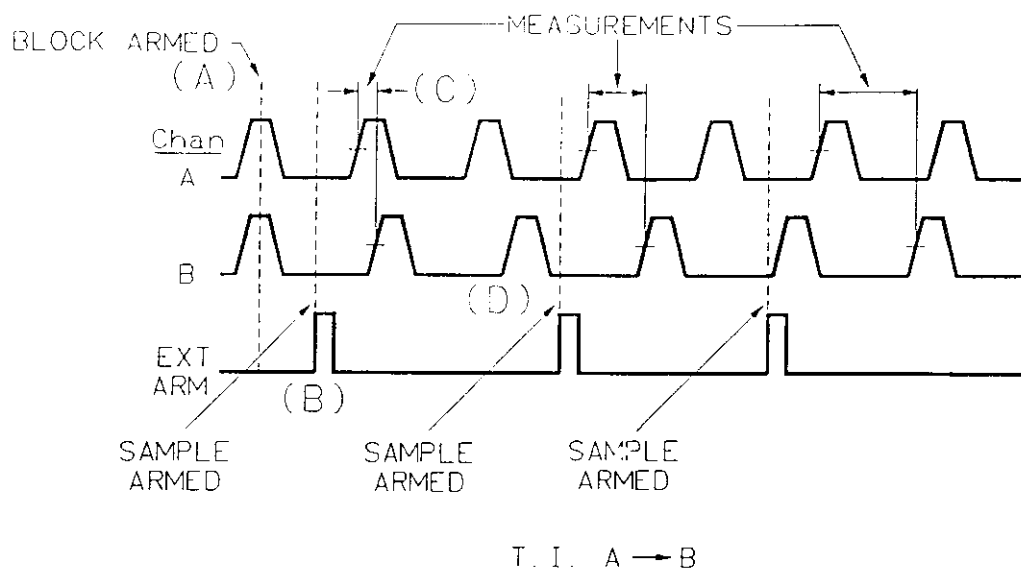
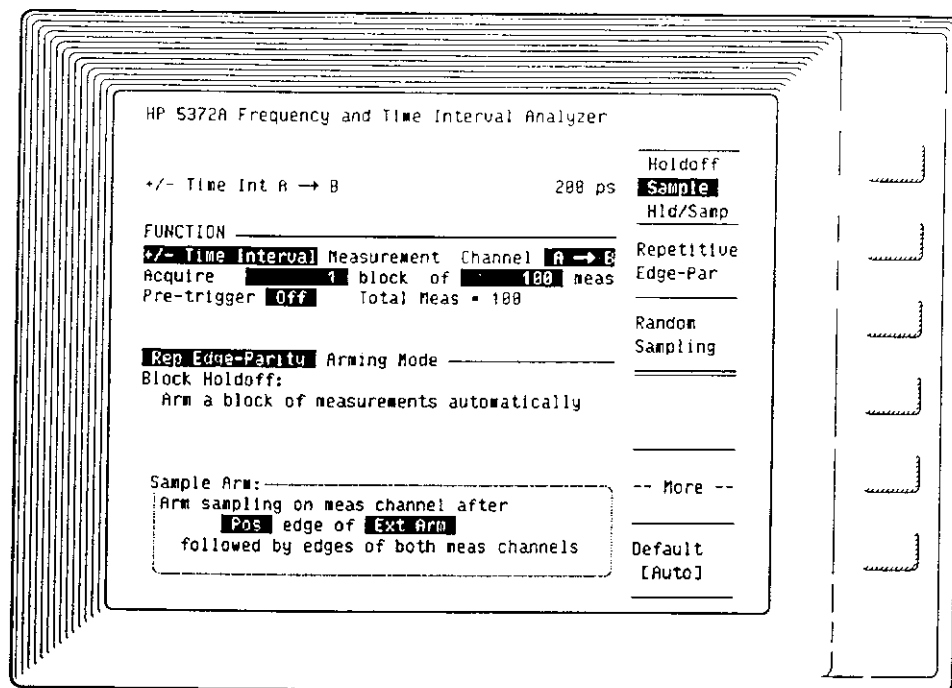

Figure 5-28. REPETITIVE EDGE Timing Diagram

- (A) Block of measurements is armed as soon as the Analyzer is ready.
- (B) A positive edge of Ext Arm arms the start of the first measurement.
- (C) The first measurement starts on the next trigger event of Channel A and ends on the following trigger event of Channel B.
- (D) Another positive edge of Ext Arm is required before the start of each measurement.

## Repetitive Edge-Parity

Figure 5-29.  
REPETITIVE  
EDGE-PARITY  
Menu Screen



**MEASUREMENTS:** ± Time Interval (two-channel)

**ARMING:** Continuous

**BLOCK HOLDOFF:** Automatic

**SAMPLE ARM:** Edge on Channel A, B, or Ext Arm followed by parity

**COMMENTS:** After an edge on Channel A, B, or Ext Arm followed by an edge on each of two input channels, A and B, a measurement is made. This arming mode is useful for applications where it is important to maintain a certain sequence for two edges you are measuring. For example, you want to measure time intervals between two edges that lead and follow one another randomly.

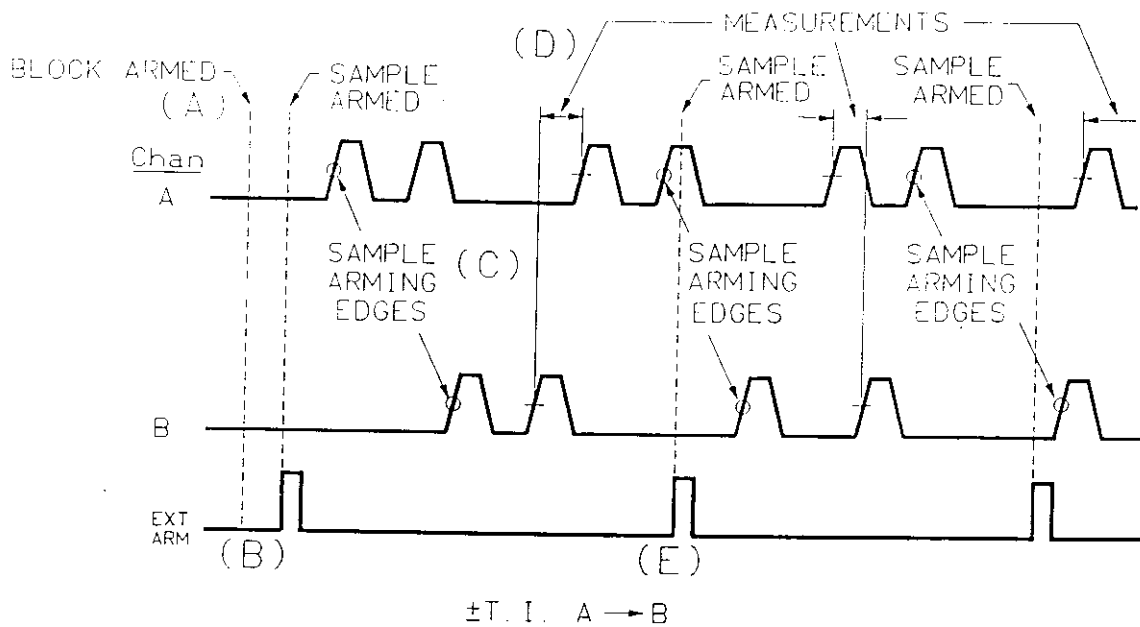

WF67\_N3

Figure 5-30. REPETITIVE EDGE-PARITY Timing Diagram

- (A) Block of measurements is armed as soon as the Analyzer is ready.
- (B) A positive edge of Ext Arm followed by (C) arms the start of a measurement.
- (C) A trigger event on both Channel A and B is required before a measurement can be acquired.
- (D) After a sample arm requirement of an edge and a trigger event on each of the measurement channels, a measurement is taken on the next pair of Channel A and B trigger events. The sequence of (B) and (C) is repeated for each measurement.
- (E) The next positive edge of Ext Arm begins the sample arming sequence again.

## Random Sampling

Figure 5-31.  
RANDOM SAMPLING  
Menu Screen

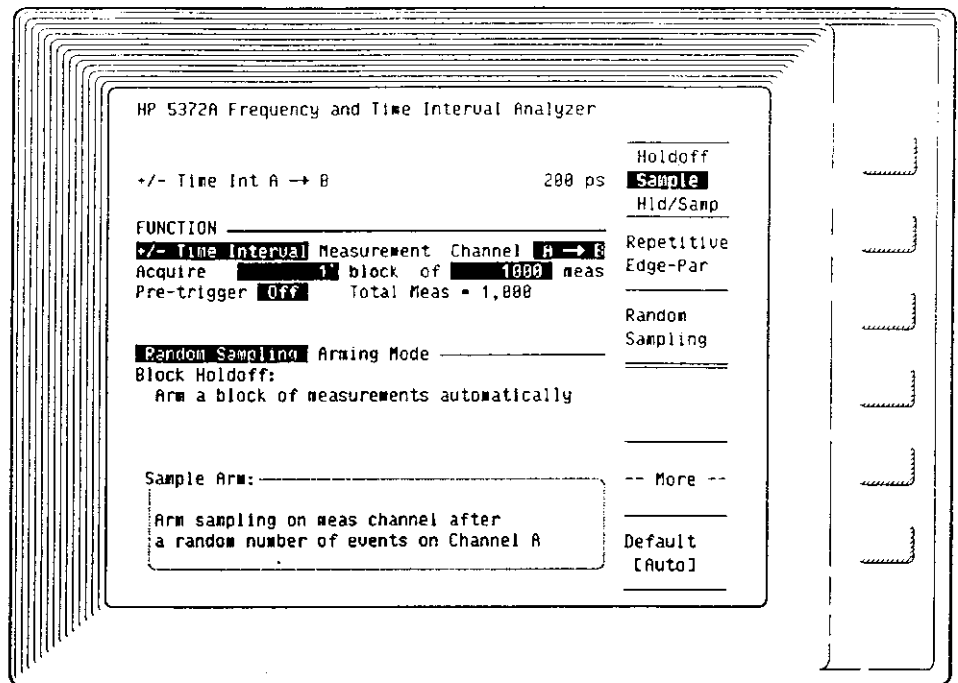

MEASUREMENTS: Time Interval, ± Time Interval

ARMING: Continuous

BLOCK HOLDOFF: Automatic

SAMPLE ARM: 4 to 15 edges on Channel A (maximum Channel A frequency for randomizer is 100 MHz)

COMMENTS: Measurements take place following a random number of edges on Channel A. This sampling mode is useful for measuring time intervals that could occur during the period when data samples are stored by the HP 5372A to memory. This could happen with intervals less than 200 ns. If one or more of the time intervals are synchronized to the data collection rate, so they always occur during memory access, they will never be measured. Random sampling ensures that all time intervals have an equal chance of being measured. Because of the delays introduced into the measurement sequence by the random sampling technique, a time interval measurement is being acquired, on average, at a rate of one every six edges on Channel A. To guarantee that a reasonable

distribution is acquired for your signal data, use a minimum number of measurements per block of 500.

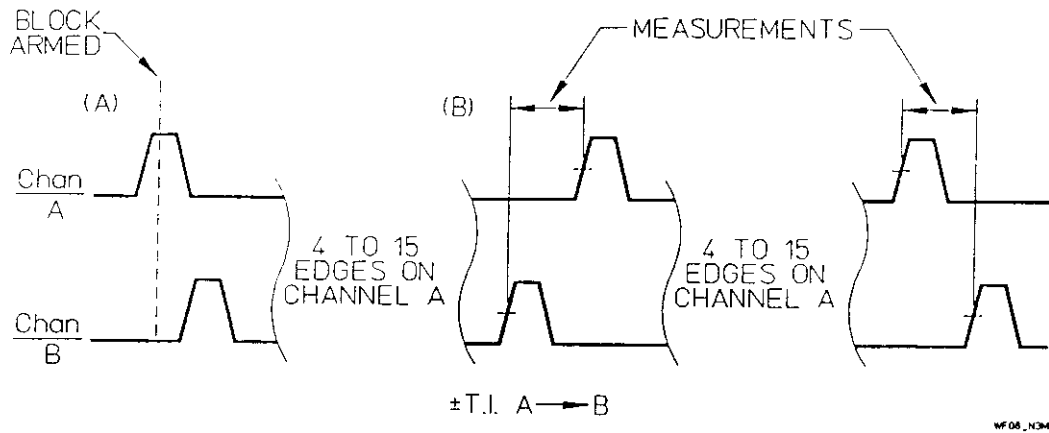

Figure 5-32. RANDOM SAMPLING Timing Diagram

- (A) Block of measurements is armed as soon as the Analyzer is ready.
- (B) Each measurement begins after a random number of edges on Channel A. The number of edges will vary from 4 to 15 between measurements.

#### NOTE

The pseudo-random sequence generator operates in a "free-run" mode. Because of this, the first measurement in a sequence can occur after fewer than four edges on Channel A. For the measurements that follow, the pseudo-random sequence generator arms a measurement every six to seventeen edges on Channel A.

**HOLDOFF/SAMPLING  
MODE**

**DESCRIPTION:**

The Holdoff/Sampling modes allow the most flexibility in determining how measurements are armed. It is possible to specify when blocks of measurements begin and when samples are collected, or when measurements start and stop.

**Edge/Interval**

Figure 5-33.  
EDGE/INTERVAL  
Menu Screen

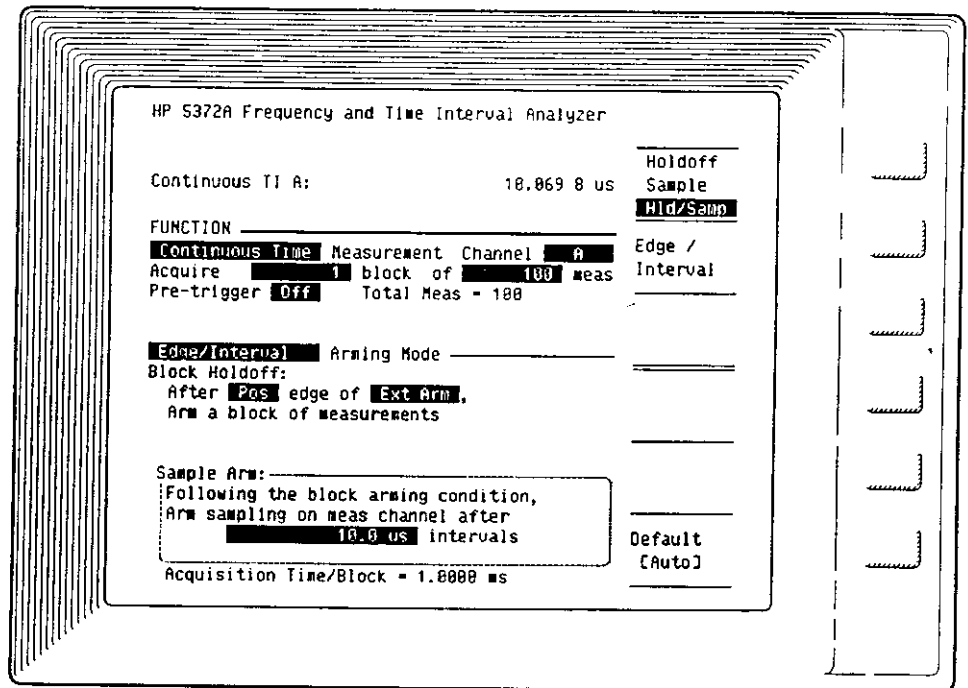

**MEASUREMENTS:** Time Interval, Continuous Time Interval, ± Time Interval, Frequency, Period, Totalize, Phase, Phase Deviation, and Time Deviation

**ARMING:** Continuous

**BLOCK HOLDOFF:** Edge on Channel A, B, or Ext Arm

**SAMPLE ARM:** Interval referenced to block holdoff edge

**COMMENTS:** The reference edge is time stamped for Frequency, Period, Continuous Time Interval, Phase Deviation, and Time Deviation measurements.



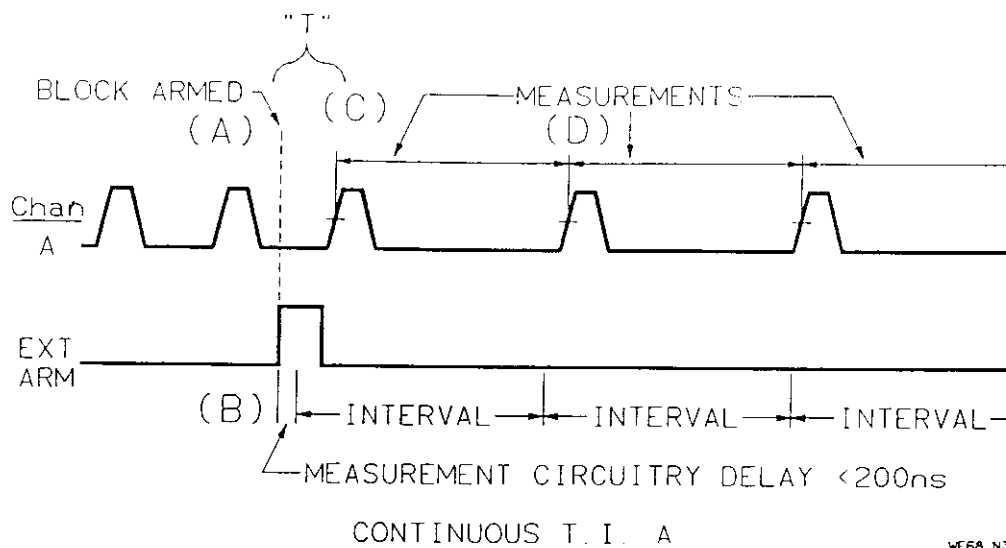
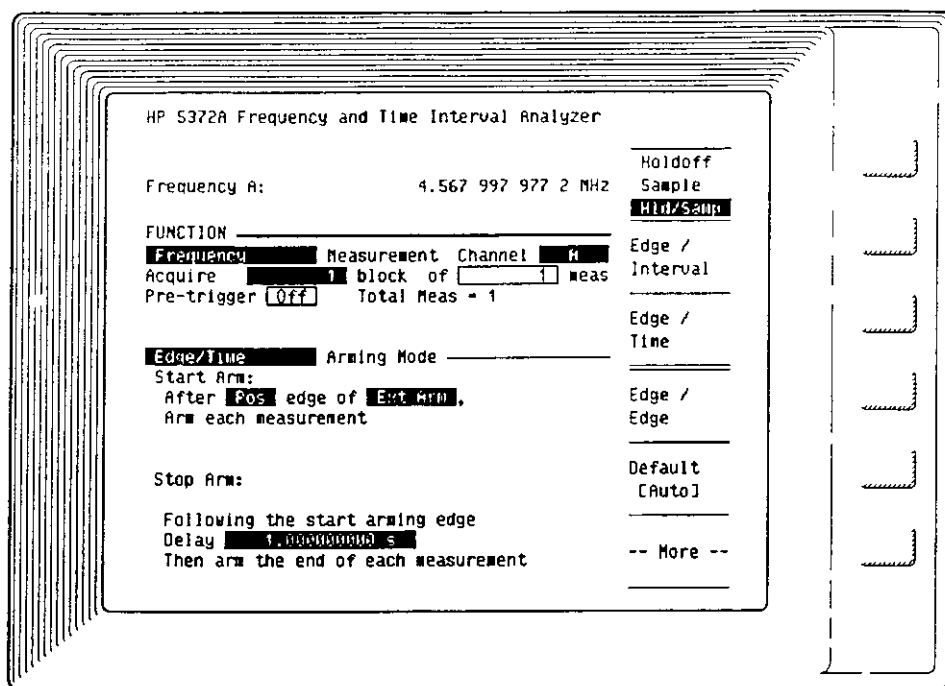

Figure 5-34. EDGE/INTERVAL Timing Diagram

- (A) Block of measurements is armed after a positive edge on Ext Arm.
- (B) The first specified interval then begins after the internal circuitry delay.
- (C) The first measurement begins on the trigger event of Channel A after the start of the first interval.
- (D) The first measurement ends, and the second measurement begins, on the trigger event following the end of the first interval. Each of the measurements end on the trigger event following the specified interval.

## Edge/Time

Figure 5-35.  
EDGE/TIME  
Menu Screen



MEASUREMENTS: Frequency and Period

ARMING: Non-continuous

START ARM: Edge on Channel A, B, or Ext Arm

STOP ARM: Time referenced to the start arm edge.

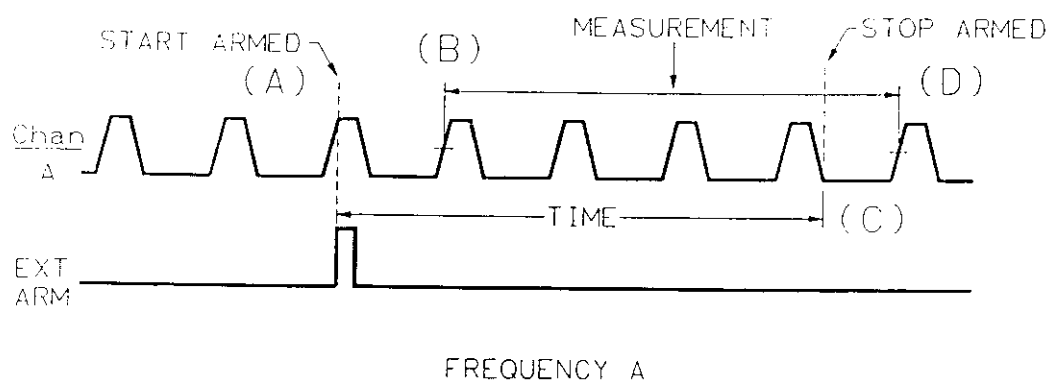

WF69\_N3

Figure 5-36. EDGE/TIME Timing Diagram

- (A) Measurement start is armed after a positive edge on Ext Arm. The time period is also referenced to this edge.
- (B) The measurement starts on the trigger event of Channel A following the arming signal.
- (C) The end of the time period arms the end of the measurement.
- (D) The measurement ends on the trigger event of Channel A following the end of the time period.

## Edge/Edge

Figure 5-37.  
EDGE/EDGE  
Menu Screen

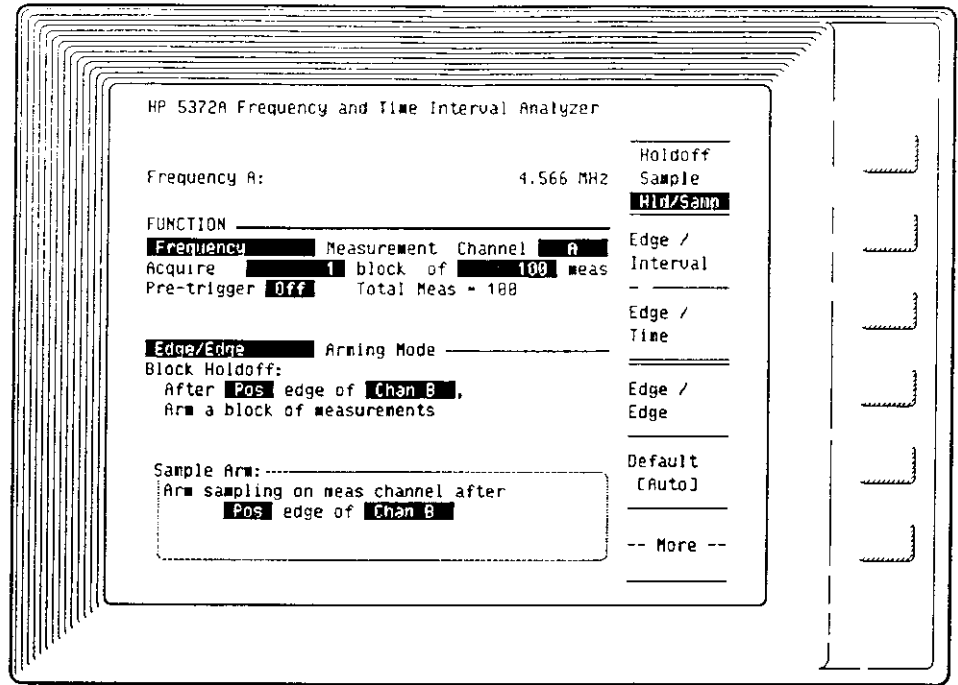

MEASUREMENTS: Frequency, Period, and Totalize

ARMING: Continuous

BLOCK HOLDOFF: Edge on Channel A, B, or Ext Arm

SAMPLE ARM: Edge on Channel A, B, or Ext Arm before every sample

COMMENTS: Measurements and arming can be set to occur on the same channel. The effect would be to sample on every other edge of the input signal.

The block holdoff edge is time stamped for Frequency and Period measurements.

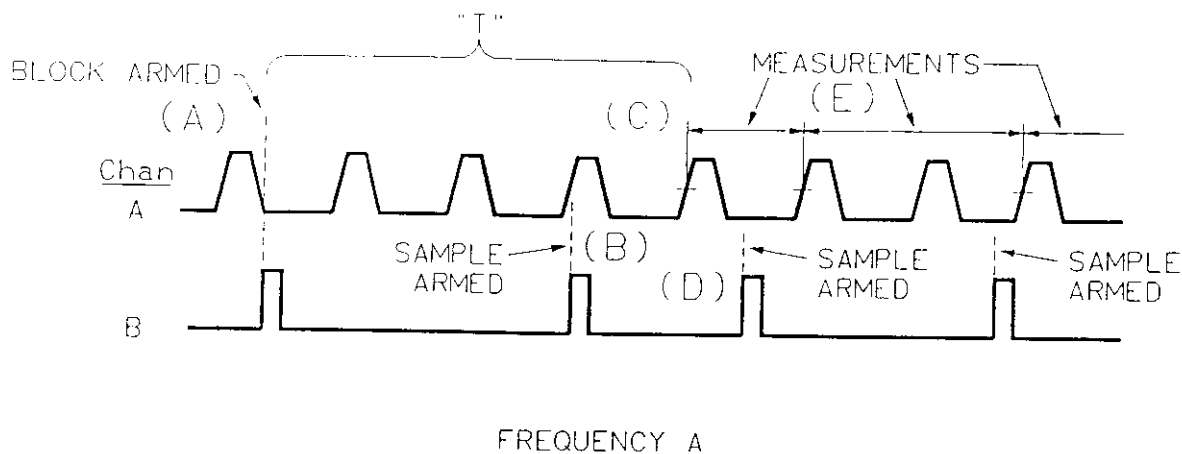

WF70\_N3

Figure 5-38. EDGE/EDGE Timing Diagram

- (A) Block of measurements is armed after a positive edge of Channel B.
- (B) Another positive edge of Channel B arms the start of the first measurement.
- (C) The first measurement starts on the trigger event of Channel A following the arming edge.
- (D) The next positive edge of Channel B arms end of the first measurement.
- (E) The first measurement ends on the trigger event of Channel A following the arming edge. Subsequent measurement samples are taken after each arming edge.

## Edge/Cycle

Figure 5-39.  
EDGE/CYCLE  
Menu Screen

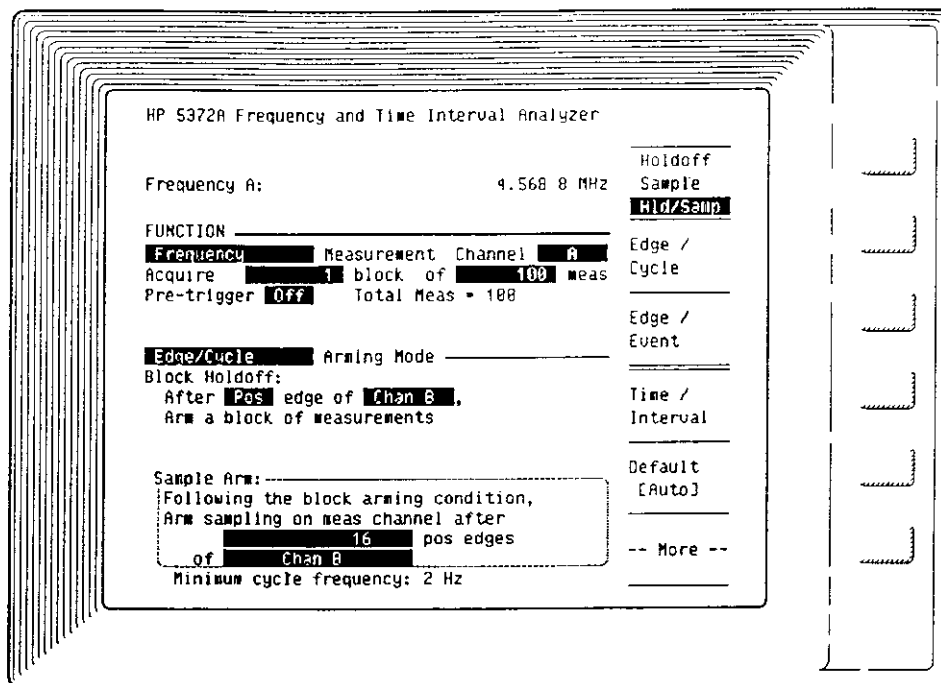

MEASUREMENTS: Frequency and Period

ARMING: Continuous

BLOCK HOLDOFF: Edge on Channel A, B, or Ext Arm

SAMPLE ARM: Cycles (events) of Channel A, B, or internal timebase

COMMENTS: Sampling takes place on the trigger event following the counting of the selected number of cycle events. If the input frequency is below the minimum cycle frequency, as shown on the Cycle arming mode screen, measurement results will be incorrect.

The block holdoff edge is time stamped for Frequency and Period measurements.

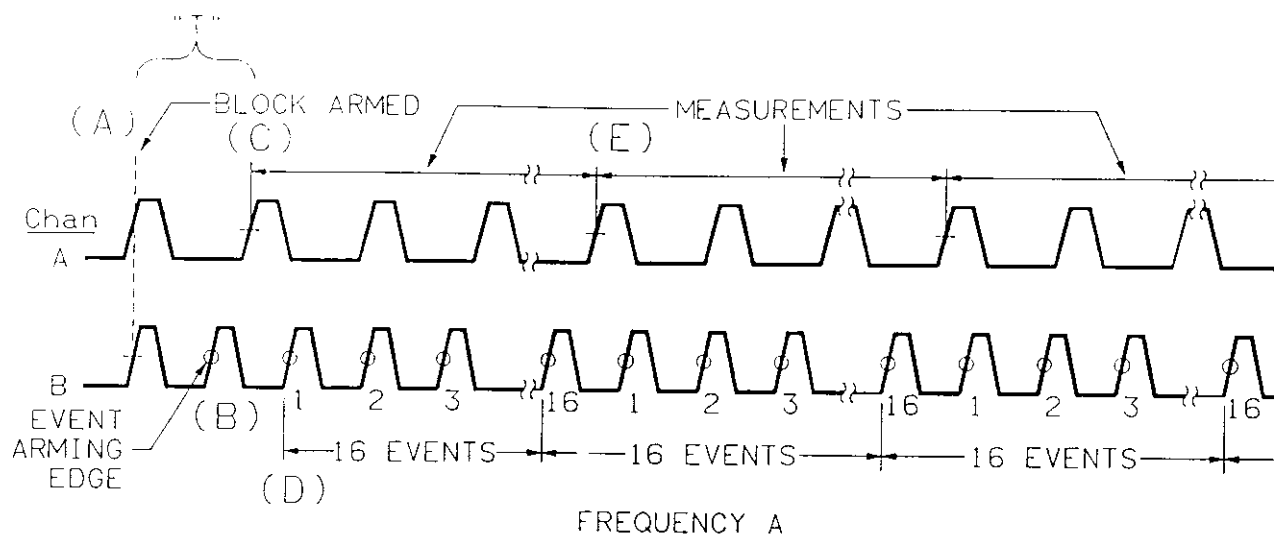

WF72\_N3

Figure 5-40. EDGE/CYCLE Timing Diagram

- (A) Block of measurements is armed after a positive edge of Channel B.
- (B) The event arming edge on the cycle channel arms the start of the first measurement and the counting of the cycles on the cycle channel. If Channel A was the measurement channel and the cycle channel, the first measurement and the cycle count would both begin on the first trigger event of Channel A, after the event arming edge.
- (C) The first measurement starts on the next trigger event on Channel A, after the event arming edge.
- (D) The counting of cycles begins on the next trigger event of the cycle channel, after the event arming edge.
- (E) The first measurement ends on the Channel A trigger event after 16 events are counted on the cycle channel. Subsequent measurement samples are taken on the trigger events after each 16 events on the cycle channel.

## Edge/Event

Figure 5-41.  
EDGE/EVENT  
Menu Screen

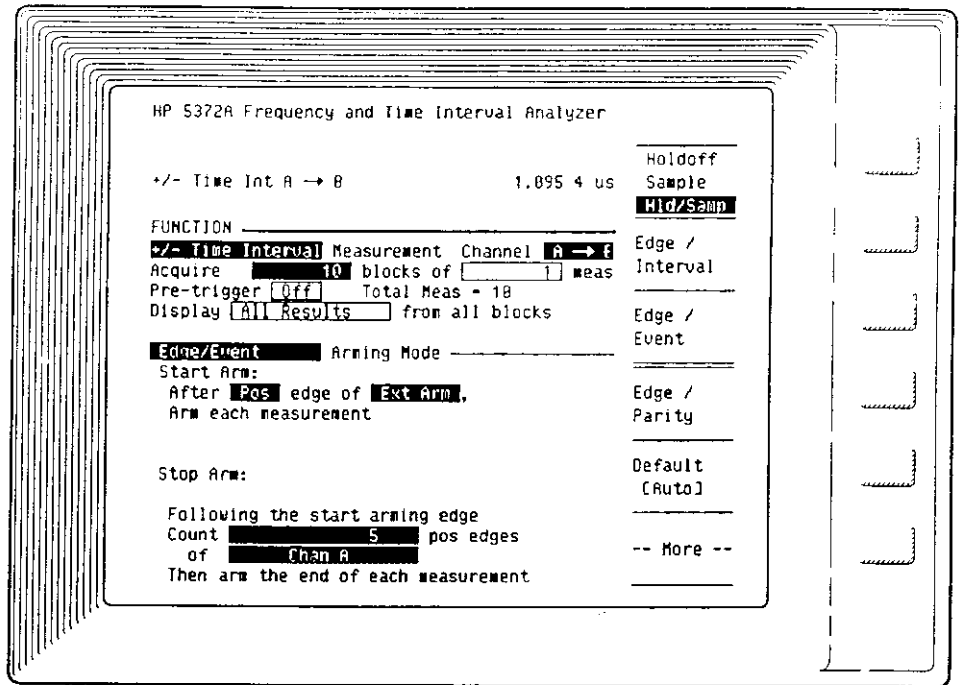

MEASUREMENTS:  $\pm$  Time Interval, Frequency, and Period

ARMING: Non-continuous

START ARM: Edge on Channel A, B, or Ext Arm

STOP ARM: Events on Channel A or B referenced to the start arm edge



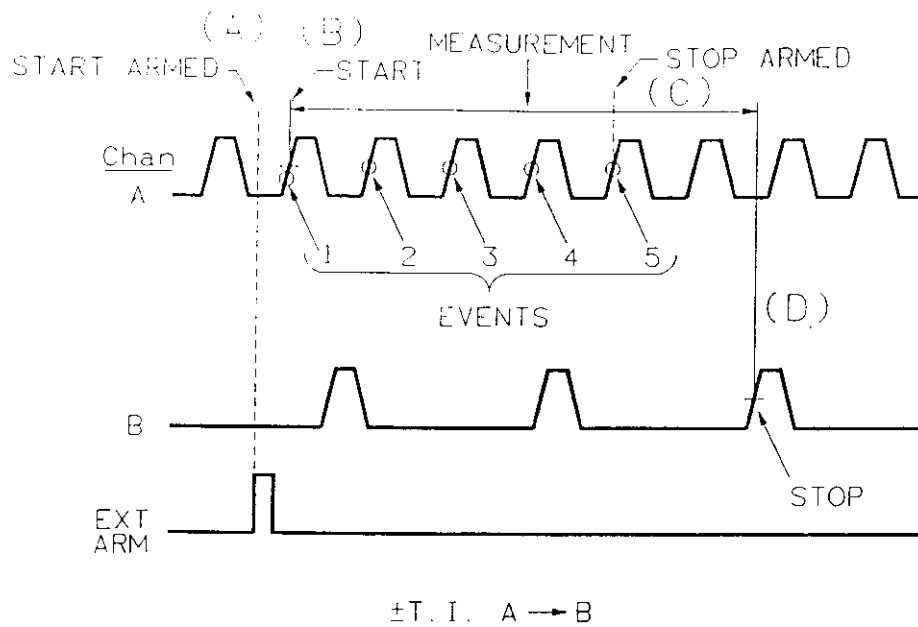
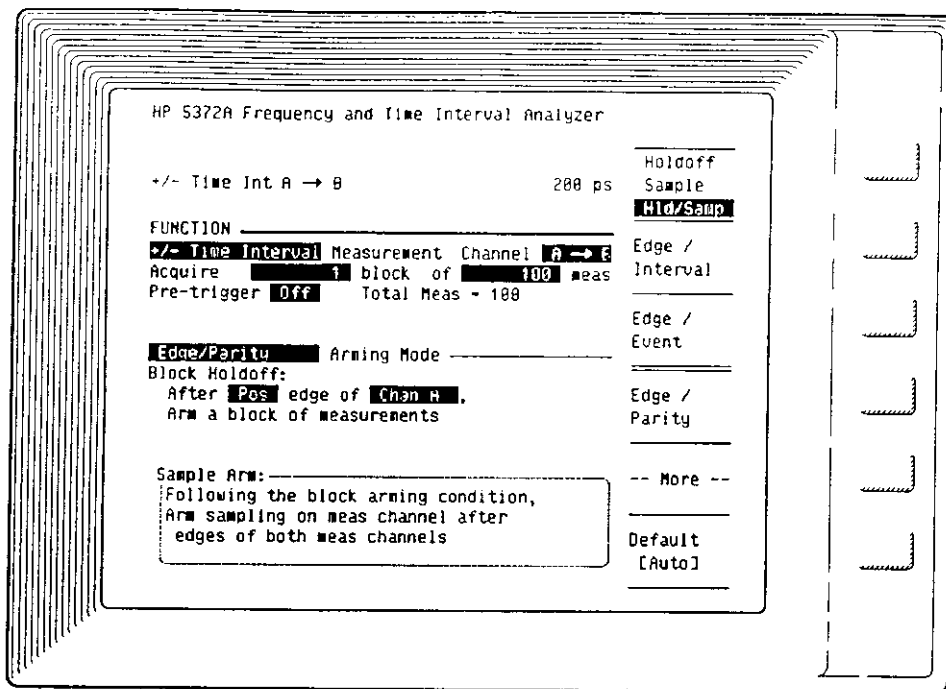

Figure 5-42. EDGE/EVENT Timing Diagram

- (A) Measurement start is armed by a positive edge on Ext Arm.
- (B) Measurement starts on the next trigger event of Channel A. The event count on Channel A starts on the same trigger event edge.
- (C) Measurement end is armed after the fifth event of Channel A.
- (D) Measurement ends on the next trigger event of Channel B.

## Edge/Parity

Figure 5-43.  
EDGE/PARITY  
Menu Screen



MEASUREMENT: ± Time Interval (two-channel)

ARMING: Continuous

BLOCK HOLDOFF: Edge on Channel A, B, or Ext Arm

SAMPLE ARM: Parity (An arming edge on Channel A and B)

COMMENTS: Following the block holdoff reference edge, each measurement is made after an edge on each of two channels, A and B. This arming mode is useful for applications where it is important to maintain a certain sequence for the two edges you are measuring. For example, you want to measure time intervals between two edges that lead and follow each other randomly.

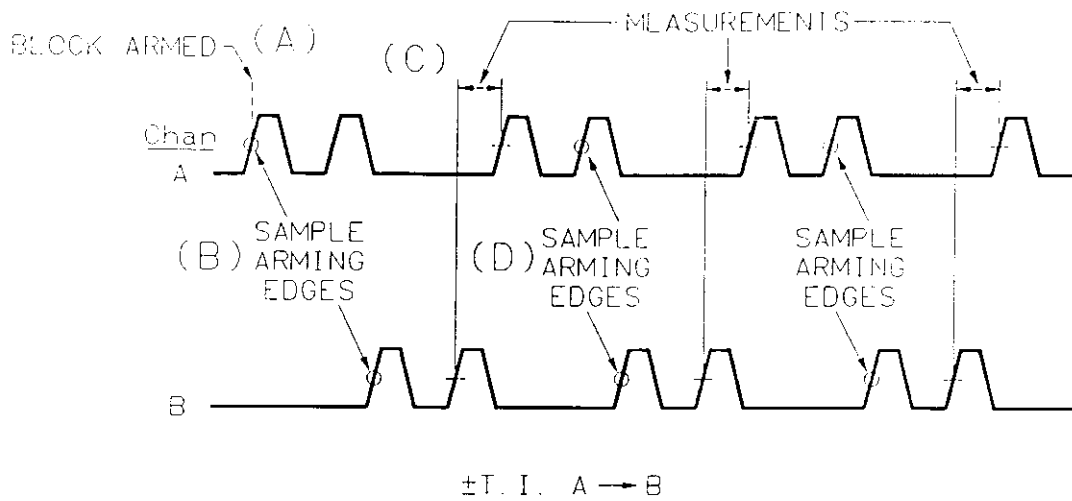

WF74\_N3

Figure 5-44. EDGE/PARITY Timing Diagram

- (A) Block of measurements is armed after a positive edge of Channel A.
- (B) A trigger event on both Channel A and B is required before a measurement can be acquired.
- (C) After the sample arm requirement of a trigger event on each of the measurement channels, a measurement is taken on the next pair of Channel A and B trigger events. The sequence of (B) and (C) is repeated for each measurement.
- (D) A trigger event on both Channel A and B arms the next measurement.

## Edge/Random

Figure 5-45.  
EDGE/RANDOM  
Menu Screen

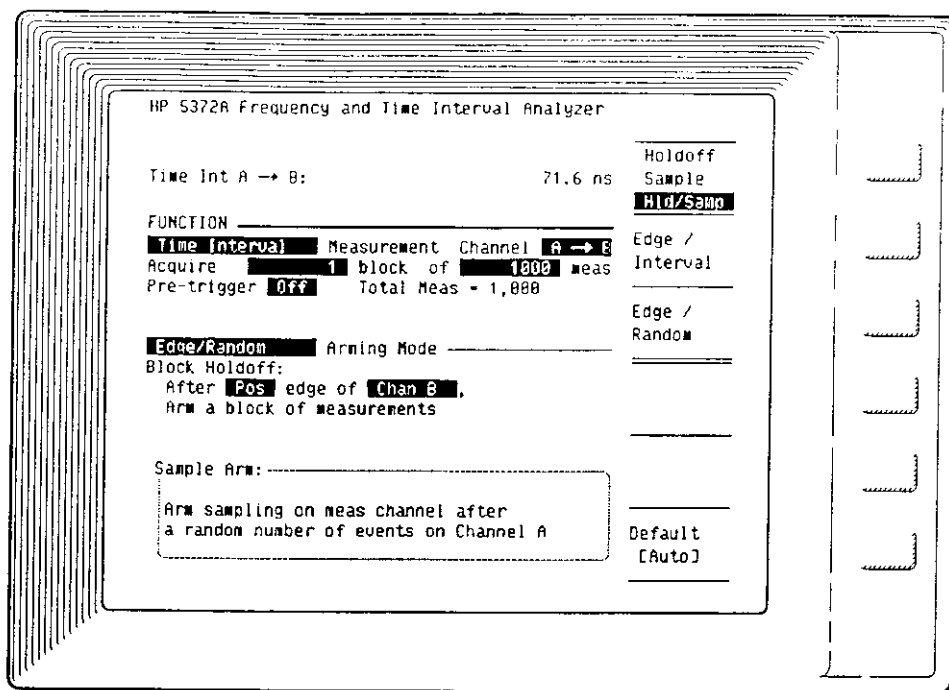

MEASUREMENT: Time Interval, ± Time Interval (two-channel)

ARMING: Continuous

BLOCK HOLDOFF: Edge on Channel A, B, or Ext Arm

SAMPLE ARM: 4 to 15 edges on Channel A (maximum Channel A frequency for randomizer is 100 MHz)

COMMENTS: Measurements take place following a random number of edges on Channel A. This sampling mode is useful for measuring time intervals that could occur during the period when data samples are stored by the HP 5372A to memory. This could happen with intervals less than 200 ns. If one or more of the time intervals are synchronized to the data collection rate so they always occur during memory access, they will never be measured. Random sampling ensures that all time intervals have an equal chance of being measured. Because of the delays introduced into the measurement sequence by the random sampling technique, a time interval measurement is acquired, on average, at a rate of one every six edges on Channel A. To guarantee that a reasonable

distribution is acquired for your signal data, use a minimum number of measurements per block of 500.

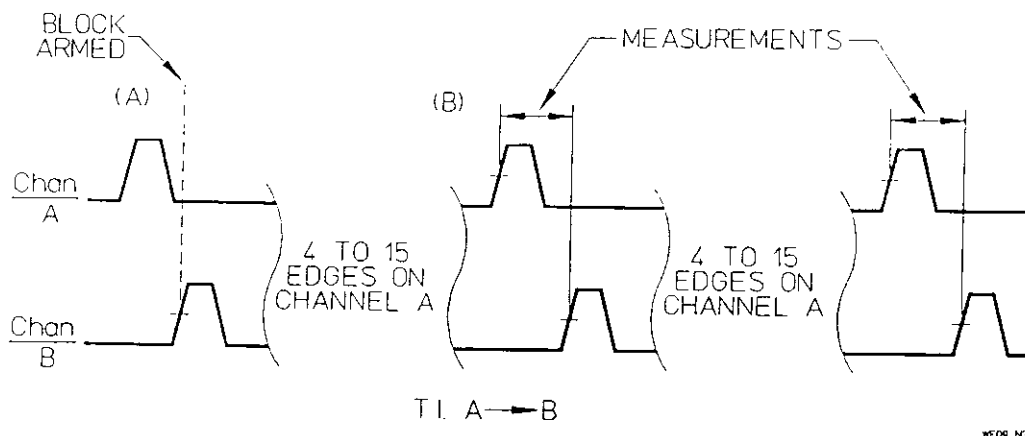

Figure 5-46. EDGE/RANDOM Timing Diagram

- (A) Block of measurements is armed after a positive edge of Channel B.
- (B) Each measurement begins after a random number of edges on Channel A. The number of edges will vary from 4 to 15 between measurements.

#### NOTE

*The pseudo-random sequence generator operates in a "free-run" mode. Because of this, the first measurement in a sequence can occur after fewer than four edges on Channel A. For the measurements that follow, the pseudo-random sequence generator arms a measurement every six to seventeen edges on Channel A.*

## Time/Interval

Figure 5-47.  
TIME/INTERVAL  
Menu Screen

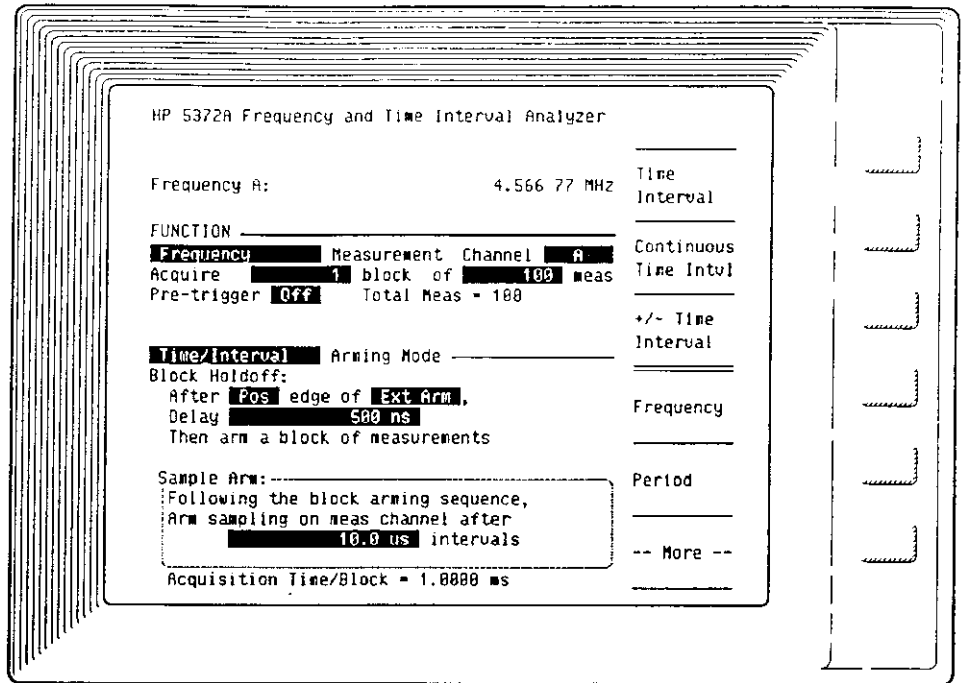

**MEASUREMENTS:** Frequency, Period, and Totalize

**ARMING:** Continuous

**BLOCK HOLDOFF:** Time referenced to an edge on Channel A, B, or Ext Arm

**SAMPLE ARM:** Interval referenced to the block holdoff conditions

**COMMENTS:** The block holdoff edge is time stamped for Frequency and Period measurements.

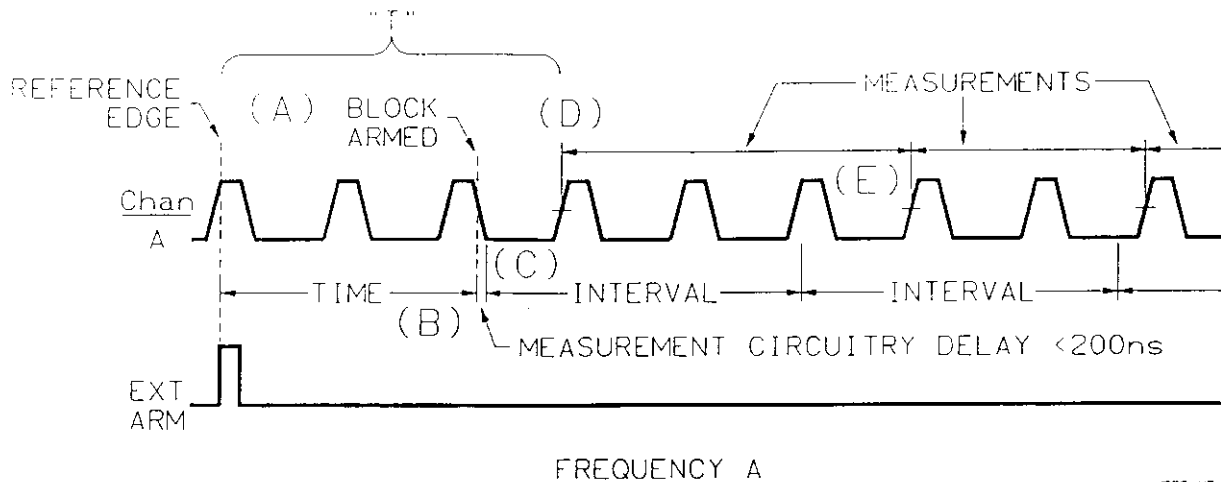
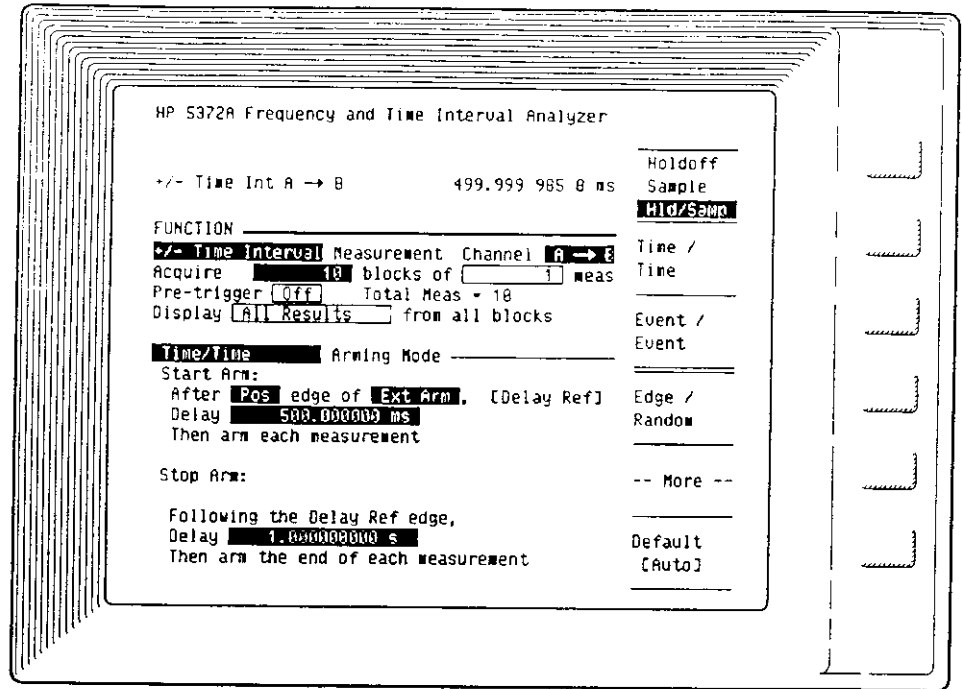

Figure 5-48. TIME/INTERVAL Timing Diagram

- (A) A positive edge of Ext Arm provides the reference edge for the time delay.
- (B) Block of measurements is armed at the end of the time delay.
- (C) The first specified interval then begins after the internal circuitry delay.
- (D) The first measurement begins on the trigger event of Channel A following the start of the interval.
- (E) The first measurement ends on the Channel A trigger event following the end of the first interval. Subsequent measurements end on the trigger event after each interval.

## Time/Time

Figure 5-49.  
TIME/TIME  
Menu Screen



MEASUREMENTS:  $\pm$  Time Interval, Frequency, and Period

ARMING: Non-continuous

START ARM: Time referenced to an edge on Channel A, B, or Ext Arm

STOP ARM: Time referenced to the start arm edge.

COMMENTS: For a  $\pm$  Time Interval measurement, if the stop arm comes before the start arm, the result will always be negative. For a Frequency measurement, the result will always be positive. This arming mode is valuable to specifically "window" a period of time with a resolution of 2 ns.



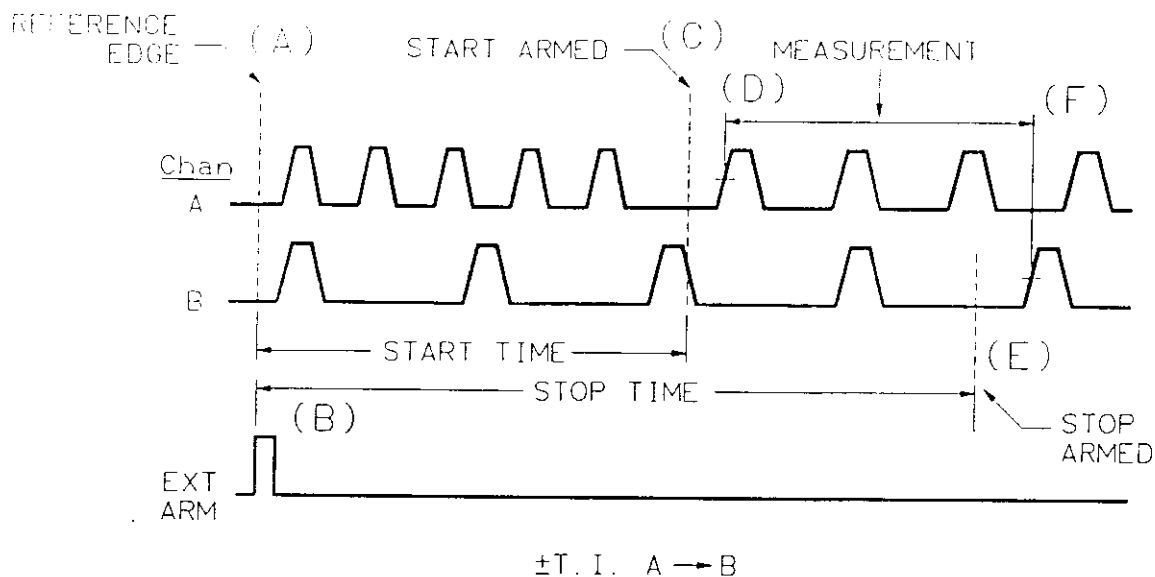
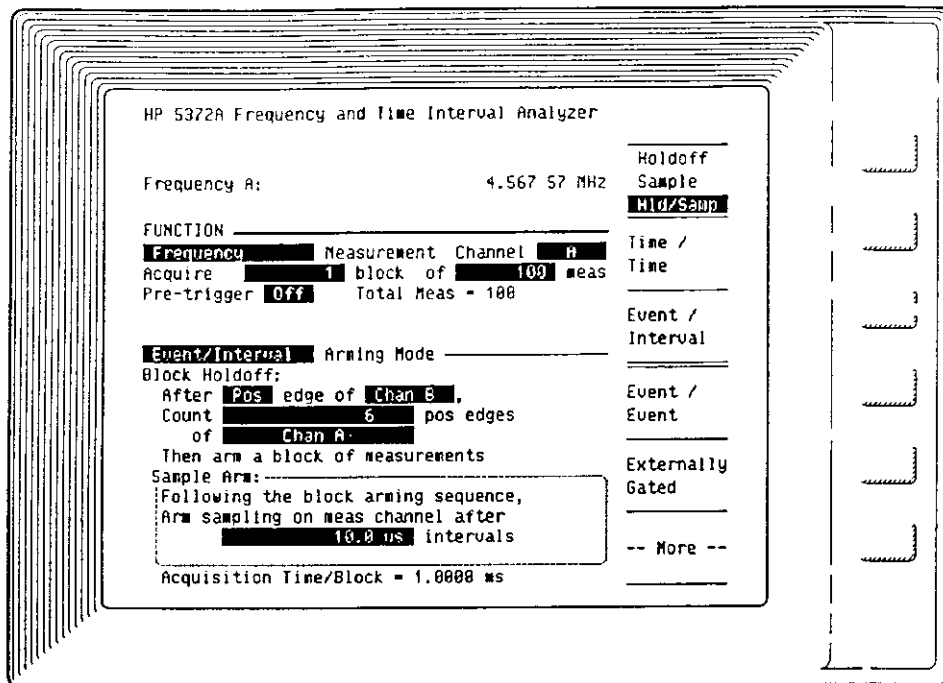

Figure 5-50. TIME/TIME Timing Diagram

- (A) A positive edge of Ext Arm provides a reference edge for the time delays.
- (B) Both the start and stop time delays are referenced to the same reference edge.
- (C) The measurement start is armed after the start time ends.
- (D) The measurement starts on the trigger event of Channel A after the start time.
- (E) The measurement stop is armed after the stop time ends.
- (F) The measurement ends on the trigger event of Channel B after the stop time.

## Event/Interval

Figure 5-51.  
EVENT/INTERVAL  
Menu Screen



MEASUREMENTS: Frequency and Period

ARMING: Continuous

BLOCK HOLDOFF: Events on Channel A or B referenced to an edge on Channel A, B, or Ext Arm

SAMPLE ARM: Interval referenced to the block holdoff conditions

COMMENTS: The block holdoff edge is time stamped for Frequency and Period measurements.

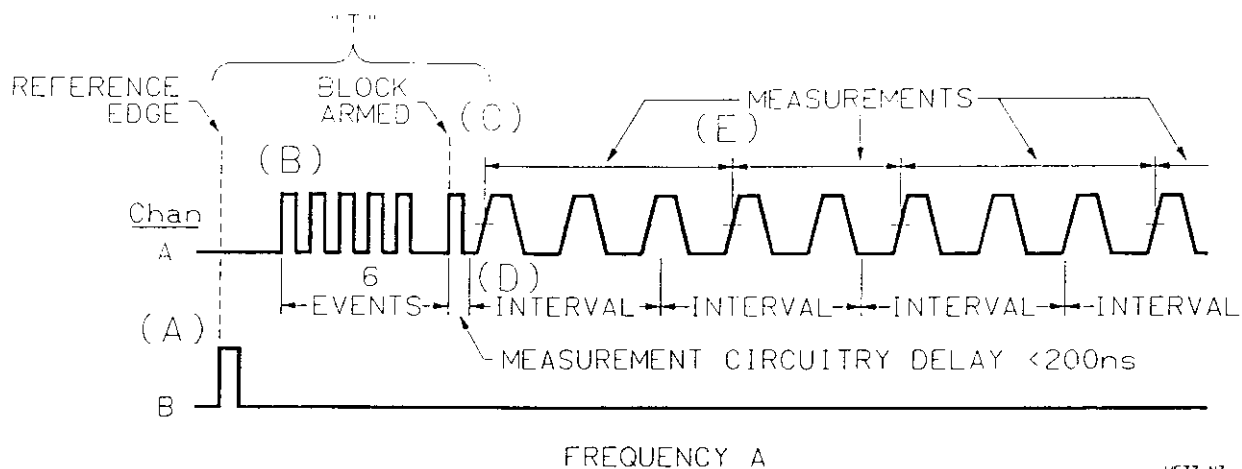

WF77\_N3

Figure 5-52. EVENT/INTERVAL Timing Diagram

- (A) A positive edge of Channel B provides the reference edge for the event delay.
- (B) The event count starts on the next positive edge of Channel A.
- (C) Block of measurements is armed after six events are counted.
- (D) The first specified interval then begins after the internal circuitry delay. The first measurement begins on the trigger event of Channel A following the start of the interval.
- (E) The measurement ends on the Channel A trigger event following the end of the first interval. Subsequent measurements end after each of the specified intervals.

## Event/Event

Figure 5-53.  
EVENT/EVENT  
Menu Screen

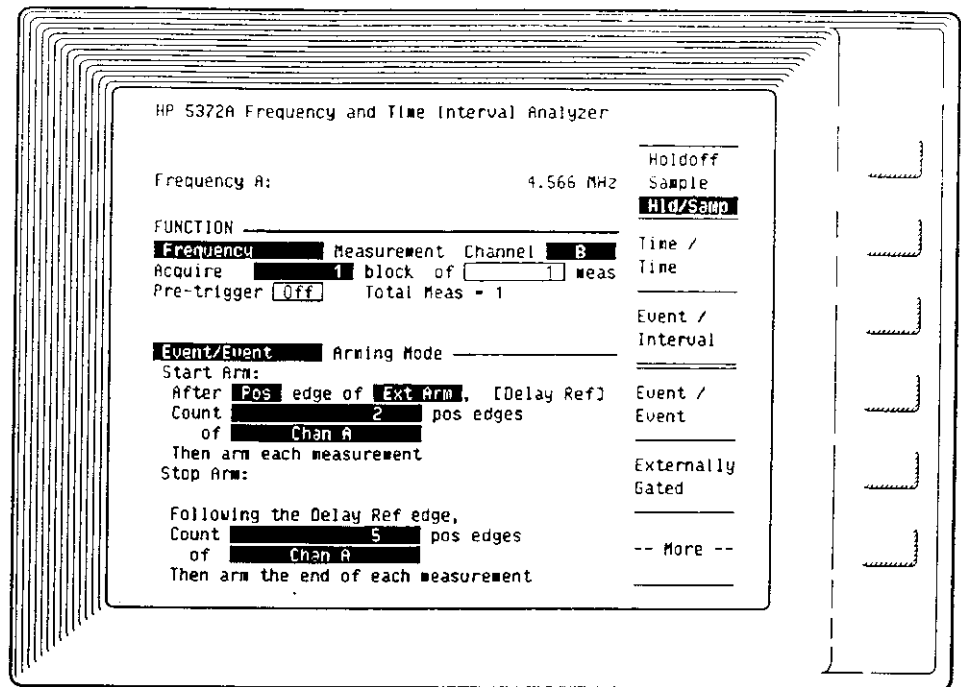

**MEASUREMENTS:** ± Time Interval, Frequency, and Period

**ARMING:** Non-continuous

**START ARM:** Events on Channel A or B referenced to an edge on Channel A, B, or Ext Arm

**STOP ARM:** Events on Channel A or B referenced to the start arm edge

**COMMENTS:** For Frequency and Period measurements, if the start arm occurs before the stop arm, results will be positive. For ± Time Interval measurements, a stop arm coming before a start arm will give a negative result.

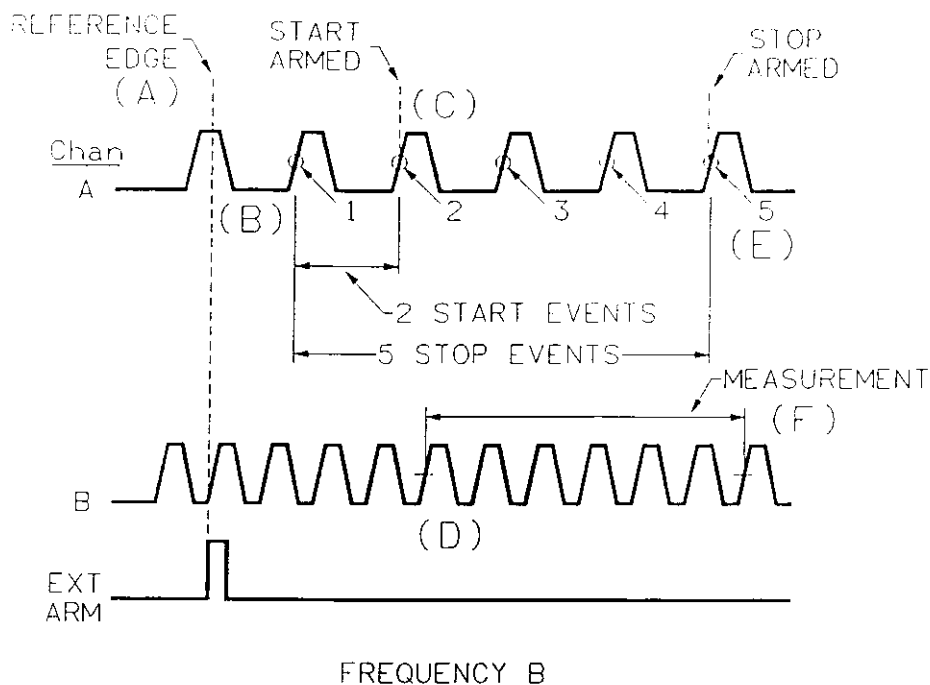

WF76\_N3

Figure 5-54. EVENT/EVENT Timing Diagram

- (A) A positive edge of Ext Arm provides the reference edge for the event delays.
- (B) The start and stop event counts begin on the trigger event of Channel A after the reference edge. In this example, the start and stop events are counted on the same channel. They can occur on different channels.
- (C) The measurement start is armed after the second positive event of Channel A, following the reference edge.
- (D) The measurement begins on the next trigger event of Channel B, after the start arm signal.
- (E) The measurement end is armed after the fifth positive event of Channel A, following the reference edge.
- (F) The measurement ends on the next trigger event of Channel B, after the stop arm signal.

## Externally Gated

Figure 5-55.  
EXTERNALLY GATED  
Menu Screen

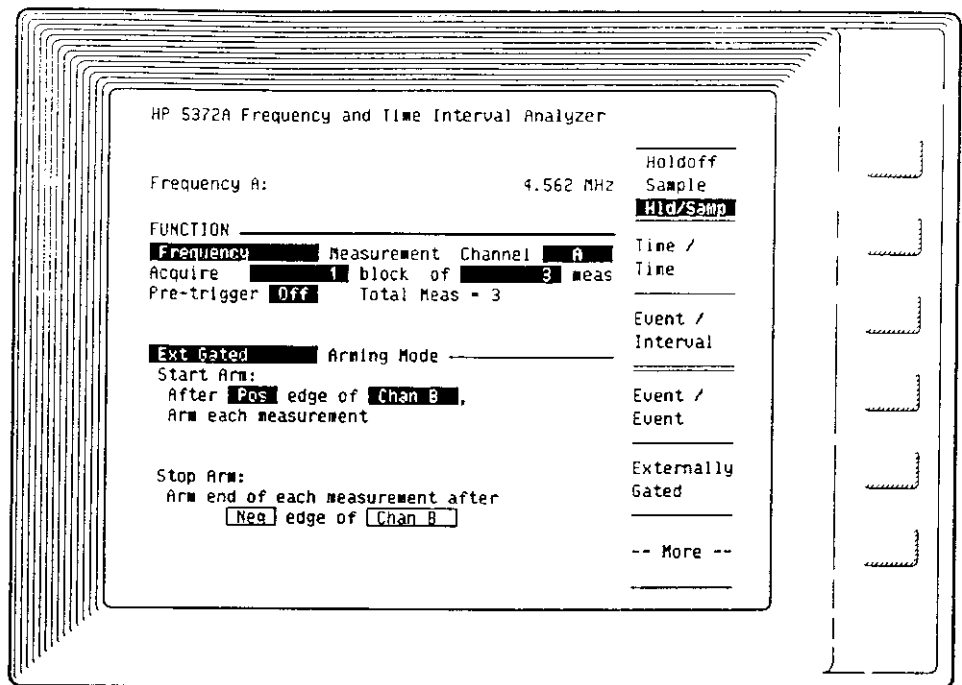

MEASUREMENTS: Frequency, Period, and Totalize

ARMING: Continuous

START ARM: Edge on Channel A, B, or Ext Arm

STOP ARM: Opposite edge of start arm pulse

COMMENTS: The start and stop of the measurement is armed by the leading and trailing edge of a positive or negative pulse on Channel A, B, or External Arm.

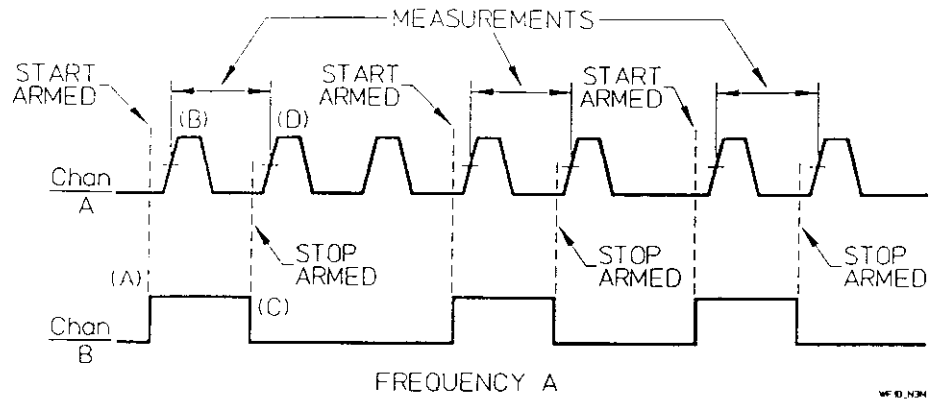
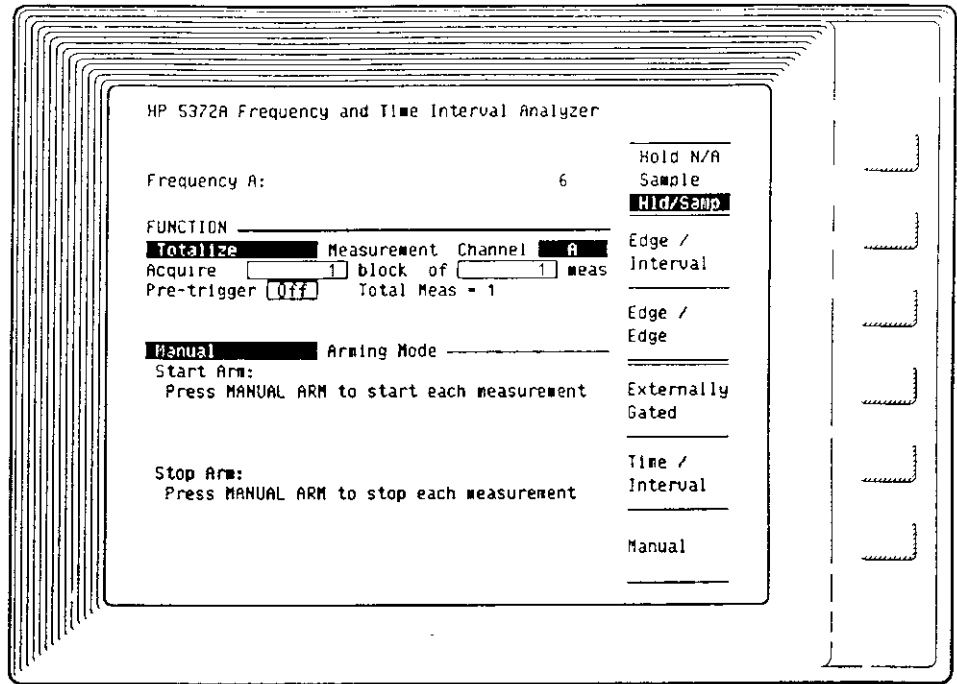

Figure 5-56. EXTERNALLY GATED Timing Diagram

- (A) Start of measurement is armed by the positive edge of Channel B.
- (B) Measurement starts on the trigger event of Channel A following start arming signal.
- (C) End of measurement is armed by the next negative edge of Channel B.
- (D) Measurement ends on the trigger event of Channel A following stop arming signal.

## Manual

Figure 5-57.  
MANUAL  
Menu Screen



**MEASUREMENT:** Totalize

**ARMING:** Non-continuous

**START MEASUREMENT:** Press **Manual Arm** key once.

**STOP MEASUREMENT:** Press **Manual Arm** key again.

**COMMENTS:** This arming mode is only available for Totalize measurements. When the front-panel **Single/Repet** key is set to Repetitive, successive measurements will accumulate. When in Single mode, the **Restart** key must be pressed between measurements, and successive measurements do not accumulate.



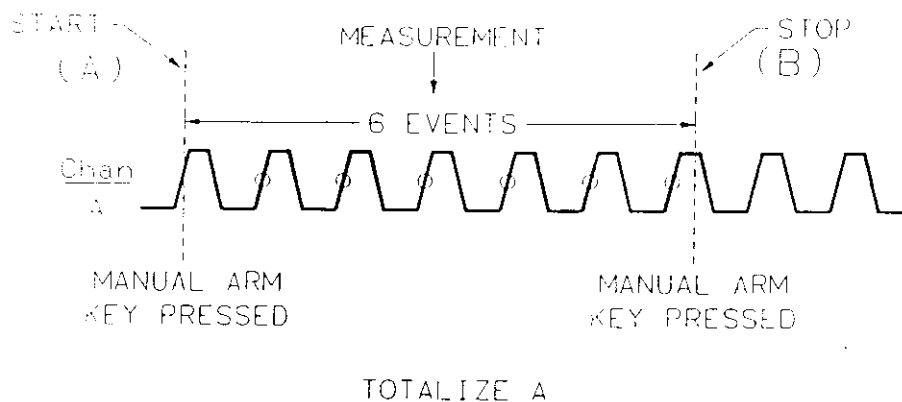

WF79\_N3

Figure 5-58. MANUAL Timing Diagram

- (A) Measurement starts when the **Manual Arm** key is pressed.
- (B) Measurement stops when the **Manual Arm** key is pressed a second time. The measurement result is the total number of trigger events that occurred on Channel A between the key presses.



000000







## Contents of Chapter

---

Chapter Overview .....	6-1
Front Panel Organization .....	6-1
Results Area .....	6-1
Menu Selection Area .....	6-2
Data Entry Area .....	6-3
HP-IB Status Area .....	6-4
Local key .....	6-4
RMT LED .....	6-4
LSN LED .....	6-4
TLK LED .....	6-4
SRQ LED .....	6-4
Instrument Control Area .....	6-4
GATE LED .....	6-5
Restart key .....	6-5
Single/Repet key .....	6-5
Manual arm key .....	6-5
ABORT function .....	6-6
Immediate Abort .....	6-7
Abort At End Of Block .....	6-7
No Abort Executed .....	6-8
Save key .....	6-8
Recall key .....	6-8
Preset key .....	6-9
Default Meas Setup function .....	6-11
Cursor/Scroll — Entry/Marker Section .....	6-15
Display Screen and Softkey Area .....	6-15
Additional Keys Area .....	6-16
Status key .....	6-16
Print key .....	6-16
Shift key .....	6-16

	CANCEL COPY function .....	6-16
	PLOT GRAPH function .....	6-17
	Power Switch .....	6-17
	Power-Up Condition .....	6-17
	Front Panel Inputs .....	6-18
	Channel A and Channel B .....	6-18
	External Arm .....	6-18
	Channel C (Option 030 or Option 090) .....	6-19
	Rear Panel Features .....	6-20
	Line Power Module .....	6-20
	HP-IB Connector .....	6-20
	Option 060, Rear Panel Inputs .....	6-20
	Option 090, Rear Panel Inputs with Channel C .....	6-20
	Frequency Standard .....	6-21
	External Input .....	6-21
	Output .....	6-21
	Gate Outputs .....	6-21
	Time Interval .....	6-22
	Continuous Time Interval .....	6-22
	± Time Interval .....	6-22
	Frequency and Period .....	6-23
	Totalize .....	6-24
	Rise/Fall Time, Pos/Neg Pulse Width, Duty Cycle, Phase .....	6-24
	Arm Delay Outputs .....	6-25
	Automatic .....	6-25
	Edge Holdoff .....	6-25
	Time Interval .....	6-25
	Continuous Time Interval .....	6-26
	± Time Interval .....	6-26
	Frequency and Period .....	6-26
	Inhibit Input .....	6-28
	Time Interval Detect .....	6-28
	FastPort (Option 020) .....	6-29

## FRONT PANEL / REAR PANEL

---

### CHAPTER OVERVIEW

This chapter describes the front panel's functional layout and the front-panel keys. The rear panel's input and output features are described, as well.

### FRONT PANEL ORGANIZATION

The HP 5372A has been designed so that related controls and features are grouped together. As a result, its front panel is divided into eight functional areas. These are:

- Results
- Menu Selection
- Data Entry
- HP-IB Status
- Instrument Control
- Cursor/Scroll — Entry/Marker
- Display Screen and Softkeys
- Additional Keys

### RESULTS AREA

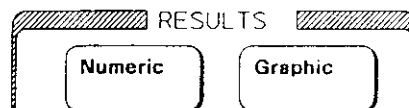

The RESULTS keys are located at the top of the front panel adjacent to the instrument display screen. These keys control the display of numeric and graphic data. The function of each key is discussed in detail in its own chapter of this manual.

## MENU SELECTION AREA

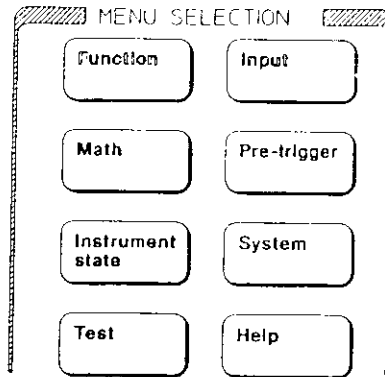

The MENU SELECTION keys are located below the RESULTS keys. The function of each key is discussed in detail in its own chapter of this manual. Here is a short description of the features behind each of the menu selection keys:

- **Function** — Use to select the measurement function, the number of measurements, and the arming of the measurement.
- **Input** — Use to define the trigger event and select input signal conditioning.
- **Math** — Use to select post-processing math, statistics, and limit testing.
- **Pre-trigger** — Use to specify the conditions for pre-trigger, TI Detect, and Measurement Inhibit.
- **Instrument State** — Use to display the contents of each Save/Recall register and to set overwrite protection.
- **System** — Use to set the HP-IB configuration, display installed options, select data width (Measurement Mode), set the system clock, and blank the display.
- **Test** — Provides diagnostic tests for a service technician when a failure of the instrument is suspected.
- **Help** — Use to display summarized instrument operating information.



## DATA ENTRY AREA

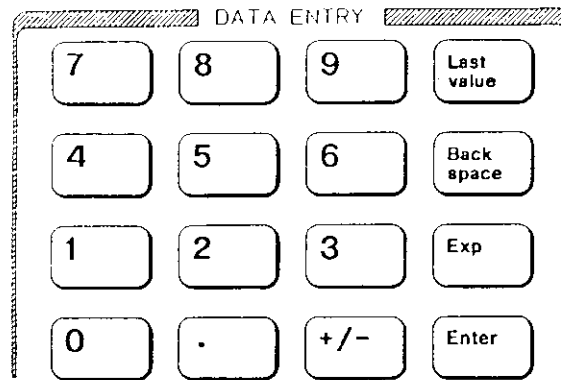

Data Entry keys are used to enter numbers into the numeric fields of the menu screens.

- Use digits, 0 to 9, and "." (decimal point) to enter numbers.
- Use the  $\pm$  key to change the sign of the number being entered. The change-sign key will apply to the exponent when the exponent is displayed.
- Pressing the **Exp** (exponent) key adds "E+00" to the number already displayed. While in this mode, the digit and change-sign keys apply to the value of the exponent.
- The **Last value** key terminates the data entry mode without saving the entered value. The previous value is restored.
- The **Back space** key erases the last digit entered in the numeric field during a data entry sequence.
- The **Enter** key completes a data entry sequence by accepting and saving the entered value.

## HP-IB STATUS AREA



The Local key and four LEDs make up the HP-IB status area.

### Local key

Pressing this key returns the HP 5372A to front panel control when in remote operation. This key is ignored when the Local Lockout mode is enabled.

### RMT LED

The RMT LED indicates that the HP 5372A is in the remote operating state.

### LSN LED

The LSN LED indicates that the HP 5372A is addressed to listen or is an active listener.

### TLK LED

The TLK LED indicates that the HP 5372A is addressed to talk or is an active talker.

### SRQ LED

The SRQ LED indicates that the HP 5372A is requesting service from the interface controller.

## INSTRUMENT CONTROL AREA

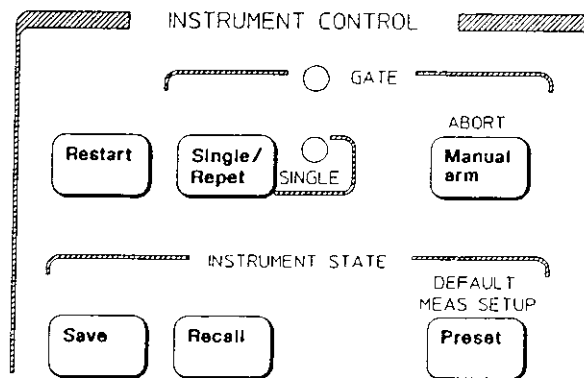

ICA\_N3M

The Instrument Control keys provide control of data acquisition, the Save/Recall registers, and the default setup of the HP 5372A.

**GATE LED**

The GATE LED comes on when the HP 5372A is acquiring data. The LED also comes on when the HP 5372A is attempting to make a measurement with no input signal connected.

**Restart key**

Pressing this key restarts a measurement process and clears cumulative results and error messages. It also terminates a data entry sequence without saving the entered value. The previous value is left unchanged.

**Single/Repet key**

Pressing this key toggles between the single and repetitive acquisition mode. When the single mode is selected, the SINGLE LED is on. The HP 5372A will execute one measurement sequence as specified on the Function menu and then stop. Each time the **Restart** key is pressed, another measurement sequence will execute. When in the repetitive mode, the measurement sequence will repeatedly execute, with a new one starting as soon as possible after the previous one ends.

**TECHNICAL COMMENT**

*The single mode is useful when first configuring the HP 5372A to make a measurement or using the Numeric or Graphic screens to view and analyze collected data. Otherwise, in repetitive mode, the instrument will begin another measurement sequence as soon as the processing for the previous one is completed. Current measurement results will be overwritten by the next sequence.*

**Manual arm key**

The **Manual arm** key provides manual control of the measurement gate for Totalize measurements made with Manual arming. Refer to chapter 3, "Special-Purpose Measurements," for a description of this arming mode.

The **Manual arm** key operates as follows when making a Totalize measurement with Manual arming:

With the **Single/Repet** key set to the single acquisition mode,

1. Pressing the **Manual arm** key opens the gate and starts the measurement.

2. Pressing it a second time closes the gate and ends the measurement.
3. The **Restart** key must be pressed before another measurement can be started.

With the **Single/Repet** key set to the repetitive acquisition mode,

1. Pressing the **Manual arm** key opens the gate and starts the measurement.
2. Pressing it a second time closes the gate and ends the measurement.
3. Pressing the **Manual arm** key a third time starts another measurement.
4. Pressing it a fourth time ends the measurement. The result is the accumulated results of both the first and the second measurements.
5. Any additional measurements will add to the total count. Pressing the **Restart** key will clear the totalize count. The next measurement will begin at zero.

## **ABORT function**

This is a shifted function. It involves a two-key sequence. First press the **Shift** key and then the **Manual arm** key.

The Abort feature can be used to retrieve partial measurement data when a measurement sequence, for some reason, does not run to completion. For example, a measurement sequence would not finish if the input signal was removed prematurely, or if there were not enough input events to satisfy the requirements of the measurement sequence.

Abort can also be used to interrupt a measurement sequence that would require too much time if it were allowed to run to completion. Measurement data acquired up to point at which the sequence was aborted can be displayed on the Numeric and Graphic result screens. A measurement acquisition must be in progress at the time of the abort.

The type of measurement setup on the Function menu determines the amount of measurement data available at the time of an abort. Below the Pre-trigger On/Off selection field on the Function menu, the following messages can appear. If none of these appear for your measurement setup, then behavior will be as for "All Results":

- "Display All Results from all blocks" — All measurements acquired up to the time of the abort will be displayed on the Numeric screen, Histogram graph, Time Variation graph, and the Event Timing graph.
- "Display Averaged Results from all blocks" — All measurements acquired up to the time of the abort will be included in the Histogram graph. The Numeric screen, the Time Variation and Event Timing graphs show the averaged data results from the blocks of measurements collected to that point.
- "Results will be most recently acquired block" — All measurements acquired up to the time of the abort will be included in the Histogram graph. Only the last block of data to be acquired before the abort will be available on the Numeric screen, the Time Variation, and the Event Timing graphs.

#### IMMEDIATE ABORT

Abort will execute an immediate halt in data collection under these conditions:

1. Single acquisition mode is selected with the **Single/Repet** key, and
2. Measurement is not Totalize with Manual arming, and
3. Measurement setup does not produce averaged results.

#### ABORT AT END OF BLOCK

Abort will execute a halt in data collection at the completion of the next block of measurements under these conditions:

1. Single acquisition mode is selected with the **Single/Repet** key, and
2. Measurement is not Totalize with Manual arming, and
3. Measurement setup produces averaged results, and

4. The number of measurements exceeds the size of measurement memory. (A way to tell if measurements do not all fit in memory is to view the Function menu screen. If the "Averaged Results" field is locked out, that is, it cannot be selected with the menu cursor, the size of the measurement exceeds internal memory.)

**NO ABORT EXECUTED** Abort will not execute if any of the following conditions is true:

- Repetitive acquisition mode is selected with the **Single/Repet** key.

OR

- Measurement is Totalize with Manual arming.

OR

- Measurement setup produces averaged results from multiple blocks.

AND

- The number of measurements fits within measurement memory. (This is the case when the "Averaged Results" field on the Function menu can be selected with the menu cursor, "All Results" is the other softkey option offered for this field.)

A new measurement sequence will begin when the **Restart** key is pressed or the instrument is put into repetitive acquisition mode.

### **Save key**

Pressing this key and then a number, 1 to 9, saves the current front panel setup in one of nine non-volatile Save/Recall registers. All instrument settings, except the HP-IB configuration, are saved in the registers.

Register "0" is a recall-only storage register. It is reserved for storage of the current front-panel setup when either the Preset or Default Meas Setup function is selected.

### **Recall key**

Pressing this key followed by a number, 0 to 9, recalls a previously stored front panel setup.

**Preset key** Pressing this key initializes instrument settings to a default operating state. This key provides a quick way of recovering from a complex operating state. Whenever the **Preset** key is pressed, the current instrument setup is stored in Register "0" of the Save/Recall registers.

The following table shows the Preset conditions:

Table 6-1. HP 5372A Preset State

Function, Mode, or Value	Preset State
<b>FUNCTION MENU SETTINGS</b>	
Measurement Function	Time Interval
Measurement Channel	A
Block Size	1
Measurement Size	100
Pre-trigger	Off
Histogram Measurement Center	200.0 ns
Histogram Measurement Start	0 s
Histogram Measurement Span	400 ns
Histogram Measurement Bin Width	200 ps
Arming Mode	Automatic
Start channel	A
Start channel slope	Positive
Stop channel	A
Stop channel slope	Positive
Start delay events	1
Start delay time	200 ns
Start delay channel	A
Stop delay events	1
Stop delay interval	10 us
Stop delay time	1 s
Stop delay cycles	16
Stop delay channel	A
<b>PRE-TRIGGER MENU SETTINGS</b>	
Pre-trigger acquisition percentage	50%
Pre-trigger condition	Time Interval
TI Detect region	Above
Measurement Inhibit	Off

Table 6-1. HP 5372A Preset State (Continued)

Function, Mode, or Value	Preset State
<b>INPUT MENU SETTINGS</b>	
Input Channels	Separate
Channel A trigger slope	Positive
Channel B trigger slope	Positive
Channel A trigger mode	Single Auto
Channel B trigger mode	Single Auto
Channel A auto trigger level	50%
Channel B auto trigger level	50%
Channel A manual trigger level	0 V
Channel B manual trigger level	0 V
External Arm trigger level	0 V
Channel A Bias level	GND
Channel B Bias level	GND
Channel A Attenuation	1:1
Channel B Attenuation	1:1
Channel C Attenuation	0%
Channel A Hysteresis	Min
Channel B Hysteresis	Min
<b>MATH MENU SETTINGS</b>	
Channel A Statistics	Off
Channel B Statistics	Off
Channel C Statistics	Off
Channel A Math	Off
Channel B Math	Off
Channel C Math	Off
Channel A Offset	0
Channel B Offset	0
Channel C Offset	0
Channel A Normalize	1
Channel B Normalize	1
Channel C Normalize	1
Channel A Scale	1
Channel B Scale	1
Channel C Scale	1
Channel A Reference	0
Channel B Reference	0
Channel C Reference	0
Channel A Low limit	0
Channel B Low limit	0
Channel C Low limit	0
Channel A High limit	0
Channel B High limit	0
Channel C High limit	0
Carrier mode	Automatic
Carrier Frequency	10 MHz
Phase Result	Modulo 360



Table 6-1. HP 5372A Preset State (Continued)

Function, Mode, or Value	Preset State
<b>SYSTEM MENU SETTINGS</b>	
Result format	ASCII
Response timeout value	5 s
Response timeout	Off
Measurement mode	Normal
<b>NUMERIC SCREEN SETTINGS</b>	
Numeric format	Result
Expanded data display	Off
<b>GENERAL SETTINGS</b>	
Displayed menu	Function
Acquisition mode	Repetitive
Measurement memory	Cleared
Wait-to-send mode	Off

### Default Meas Setup function

This is a shifted function. It involves a two-key sequence. First press the **Shift** key and then the **Preset** key.

When selected, a default instrument setup will be invoked for the current measurement function. This feature is designed to provide the setup most likely to produce valid measurement results for the selected measurement function.

The following instrument conditions are invoked by Default Measurement Setup:

- The previous instrument setup is saved in storage register "0".
- Displayed menu is Numeric screen.
- Numeric results display is Results/Statistics.
- Block Size is set to 1.
- Measurement Size is set to 50 (except for Peak Amplitude where the measurement size is 1 and Histogram measurements where the measurement size is 1,000,000).
- Channel A Trigger Mode is set to Repetitive Auto Trigger.
- Channel B Trigger Mode is set to Repetitive Auto Trigger.

- Channel A Bias Level is set to GND
- Channel B Bias Level is set to GND
- Channel A Attenuation is set to 1:1.
- Channel B Attenuation is set to 1:1.
- Channel C Attenuation is set to 0%.
- Reference values are set to 0.
- Statistics are enabled.
- Math functions are disabled.
- Limit testing is disabled.
- Acquisition mode set to Repetitive

The default setup values for each measurement type are listed below:

**Time Interval:**

Arming set to Automatic.  
Source Channel set to A  
Channel A Trigger Level set to 50% (positive slope).  
Channel B Trigger Level set to 50% (positive slope).  
Input Mode set to Separate.

**± Time Interval:**

Arming set to Automatic.  
Source Channel set to A→B.  
Channel A Trigger Level set to 50% (positive slope).  
Channel B Trigger Level set to 50% (positive slope).  
Input Mode set to Separate.

**Continuous Time Interval:**

Arming set to Automatic.  
Source Channel set to A.  
Channel A Trigger Level set to 50% (positive slope).  
Channel B Trigger Level set to 50% (positive slope).  
Input Mode set to Separate.

**Frequency:**

Arming set to Automatic.  
Source Channel set to A.  
Channel A Trigger Level set to 50% (positive slope).  
Channel B Trigger Level set to 50% (positive slope).  
Input Mode set to Separate.

**Period:**

Arming set to Automatic.  
Source Channel set to A.  
Channel A Trigger Level set to 50% (positive slope).  
Channel B Trigger Level set to 50% (positive slope).  
Input Mode set to Separate.

**Totalize:**

Arming set to Interval Sampling.  
Interval Time set to 10.0  $\mu$ s.  
Source Channel set to A.  
Channel A Trigger Level set to 50% (positive slope).  
Channel B Trigger Level set to 50% (positive slope).  
Input Mode set to Separate.

**Positive Pulse Width:**

Arming set to Automatic.  
Source Channel set to A.  
Channel A Trigger Level set to 50% (positive slope).  
Channel B Trigger Level set to 50% (negative slope).  
Input Mode set to Common.

**Negative Pulse Width:**

Arming set to Automatic.  
Source Channel set to A.  
Channel A Trigger Level set to 50% (negative slope).  
Channel B Trigger Level set to 50% (positive slope).  
Input Mode set to Common.

**Risetime:**

Arming set to Automatic.  
Source Channel set to A.  
Channel A Trigger Level set to 20% (positive slope).  
Channel B Trigger Level set to 80% (positive slope).  
Input Mode set to Common.

**Falltime:**

Arming set to Automatic.  
Source Channel set to A.  
Channel A Trigger Level set to 80% (negative slope).  
Channel B Trigger Level set to 20% (negative slope).  
Input Mode set to Common.

**Duty Cycle:**

Arming set to Automatic.  
Source Channel set to A.  
Channel A Trigger Level set to 50% (positive slope).  
Channel B Trigger Level set to 50% (negative slope).  
Input Mode set to Common.

**Phase:**

Arming set to Automatic.  
Start on Positive edge of Channel A.  
Source Channel set to A relative to B (A rel B).  
Channel A Trigger Level set to 50% (positive slope).  
Channel B Trigger Level set to 50% (positive slope).  
Input Mode set to Separate.

**Phase Deviation:**

Arming set to Automatic.  
Source Channel set to A.  
Channel A Trigger Level set to 50% (positive slope).  
Channel B Trigger Level set to 50% (positive slope).  
Input Mode set to Separate.

**Time Deviation:**

Arming set to Automatic.  
Source Channel set to A.  
Channel A Trigger Level set to 50% (positive slope).  
Channel B Trigger Level set to 50% (positive slope).  
Input Mode set to Separate.

**Peak Amplitude:**

Arming set to Automatic.  
Source Channel set to A.  
Channel A Trigger Level set to 50% (positive slope).  
Channel B Trigger Level set to 50% (positive slope).  
Input Mode set to Separate.

## CURSOR/SCROLL — ENTRY/MARKER SECTION

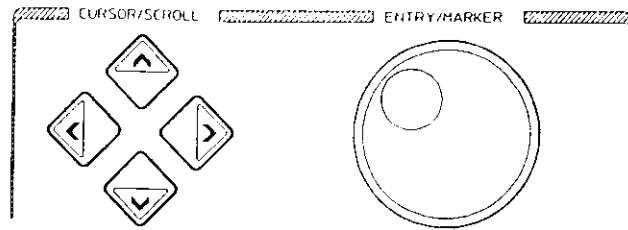

Cursor/Scroll keys are used to move the menu cursor (the highlighting that moves on the display screen from menu field to menu field) in the direction indicated on each key. These keys are also used to scroll measurement results on the Numeric screen and graph data on the Graphic screen.

Entry/Marker knob is used to modify numeric field entries by the smallest increment available. This knob is also used to control markers on the Graphic screen and to scroll displayed graphs. It can also scroll measurement results on the Numeric screen when the **Set Param/Meas #** softkey is set to **Meas #**.

## DISPLAY SCREEN AND SOFTKEY AREA

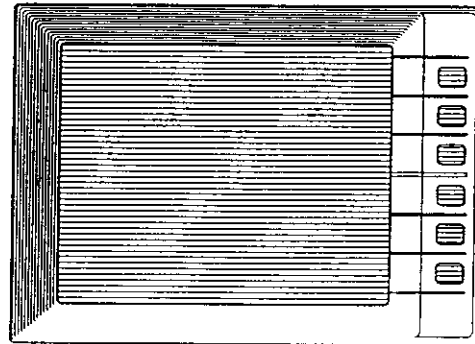

The display and softkey section contains the CRT (cathode ray tube) and the six softkeys. The CRT is a raster-scan, green phosphor display. The screen display resolution is 408 pixels horizontally by 304 pixels vertically. Graph display resolution is 250 pixels horizontally by 180 pixels vertically. The softkeys select the options that appear along the right edge of the display.

## ADDITIONAL KEYS AREA

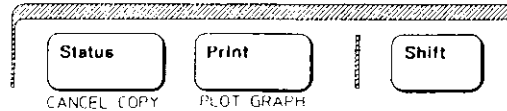

The additional keys are located above the DATA ENTRY keys.

**Status key** Pressing the **Status** key displays a summary of the current instrument settings. Along with the date and time, the current conditions for the Function, Input, Math, and Pre-trigger menus are summarized on this screen.

**Print key** Pressing this key causes the currently displayed screen on the CRT to be sent to an attached HP-IB graphics printer, such as the HP 2225A ThinkJet Printer. The following conditions must first be set on the HP 5372A System menu:

- Addressing Mode: Talk Only
- Print option: Display

The printer must be set to "LISTEN ONLY". For more information, refer to chapter 12, "System Menu."

**Shift key** The blue Shift key is used along with four other front panel keys to perform additional functions. The four keys are:

- Manual arm (ABORT function)
- Status (CANCEL COPY function)
- Print (PLOT GRAPH function)
- Preset (DEFAULT MEAS SETUP function)

The shifted functions are labeled with blue letters to show the association with the **Shift** key. To select a shifted function, press the **Shift** key and then press the function key.

### CANCEL COPY function

This feature will cause a print or plot operation in progress to be halted. To cancel a print or plot operation, press the **Shift** key and then press the **Status** key.

## **PLOT GRAPH function**

This feature causes the currently displayed Graphic screen on the CRT to be sent to an attached HP-IB HP-GL plotter, such as the HP 7440A ColorPro Plotter with Option 002. Only graphs can be plotted. These graphs are the Histogram, Time Variation, and Event Timing graphs. The following conditions must first be set on the HP 5372A System menu:

- Addressing Mode: Talk Only
- Print option: Display

To plot a graph, press the **Shift** key and then press the **Print** key.

## **POWER SWITCH**

Located at the lower-left corner of the front panel, the power switch has two settings: STBY and ON.

1. When in STBY (Standby), power is provided to the oven that keeps the timebase reference crystal at a controlled temperature. The front panel Standby LED will be on.
2. The ON setting causes power to be applied to all areas of the HP 5372A.

## **Power-Up Condition**

The instrument configuration when the HP 5372A was powered-down will be restored. The following three statements describe the condition of the HP 5372A at power-up:

1. The previous measurement is restarted.
2. Measurement and graphics display memories are cleared.
3. If the power-up memory verification test fails, default settings defined under Preset are selected, and a warning message appears on the display.

## FRONT PANEL INPUTS

The standard front panel inputs are Channel A, B, and External Arm. Channel C input (100 MHz to 2 GHz) is available as an option (Option 030).

### Channel A and Channel B



The HP 5372A accepts three types of interchangeable input pods. These pods are the point of entry for signals into the A and B channels of the instrument, unless Option 060, Rear Panel Inputs, or Option 090, Rear Panel Inputs with Channel C, is installed. The pod used dictates the termination impedance for the channel. All settings related to the Channel A and B inputs are on the Function and Input menus.

Both Channel A and Channel B have a trigger light on the front panel. The LEDs operate at two levels:

1. The LED is off when the input signal is above or below the trigger level for the input channel.
2. The LED is flashing when the input signal is triggering properly. That is, the input signal is crossing the upper and lower hysteresis levels. The trigger level is at the center of the hysteresis window.

Range: dc to 500 MHz

Damage Level: X1 ± 2.5 V (dc ± ac pk)  
 X2.5 ± 5.5 V (dc ± ac pk)

A full description of the A and B input characteristics can be found in appendix E, "Specifications."

### CAUTION

---

***Do not remove an input pod while the HP 5372A is powered on. Always set to Standby before removing or inserting an input pod. Damage to the pod can result from not following this caution.***

---

### External Arm



All settings related to the External Arm input are included on the Function and Input menu screens. The External Arm input is used for arming and /or Pre-trigger only.



The External Arm input has a trigger light on the front panel. The LED operates at two levels:

1. The LED is off when the input signal is above or below the trigger level for the input channel.
2. The LED is flashing when the input signal is triggering properly. That is, the input signal is crossing the upper and lower hysteresis levels. The trigger level is at the center of the hysteresis window.

Range: 0 to 100 MHz

Input Impedance: 1 M $\Omega$ , shunted by <50 pF

Damage Level: 5 V rms ( $\pm$  15 V pk-pk, dc  $\pm$  peak ac)

A full description of the External Arm input characteristics can be found in appendix E, "Specifications."

**Channel C**  
**(Option 030 or**  
**Option 090)**



The Channel C option extends the ability of the HP 5372A to measure frequency to 2 GHz. This is accomplished with a divide-by-4 prescaler which divides down the input frequency to the range of the 5372A. One input pulse is sent on to the measurement circuitry for every four pulses received at the Channel C input.

The Channel C can measure pulse bursts as well as CW signals. The attenuation setting for Channel C on the Input menu is useful when measuring pulsed RF signals with noise in the region between the pulse bursts.

Range: 100 MHz to 2 GHz

Trigger Level: 0 V on a Positive Slope

Input Impedance: AC coupled, 50 $\Omega$ , VSWR  $\leq$  2.5

Damage Level: AC > +20 dBm  
DC  $\pm$  5 V

A full description of the Channel C input characteristics can be found in appendix E, "Specifications."

## REAR PANEL FEATURES

The features on the rear panel are:

- Power Module
- HP-IB Cable Connector
- Option 060, Rear Panel Inputs
- Option 090, Rear Panel Inputs with Channel C
- Frequency Standard Input/Output
- Gate Outputs
- Arm Delay Outputs
- Measurement Inhibit
- Time Interval Detect
- Option 020, FastPort

### Line Power Module

Line power for the HP 5372A is provided through a three-wire power cable, which connects to a power module on the rear panel of the instrument. The power module includes provisions for selecting one of several line voltages. It also includes a protection fuse for the HP 5372A. Refer to appendix B, "Unpacking and Installing," for more information.

### HP-IB Connector

The HP-IB connector can be used for connecting the HP 5372A to a controller, or optionally, a listen-only printer or plotter. Refer to appendix B, "Unpacking and Installing," for more information on the HP-IB connector.

### Option 060, Rear Panel Inputs

These are 50 $\Omega$  BNC inputs for Channels A and B, and a 1 M $\Omega$  BNC input for External Arm available on the rear panel. Input pods cannot be used when Option 060 is installed. Channel A and B input performance is equivalent to front panel performance for this configuration. External Arm performance for the Option 060 configuration is listed under Rear Panel Connectors, appendix E, "Specifications."

### Option 090, Rear Panel Inputs with Channel C

Option 090 consists of Option 060 with the addition of a rear-panel Channel C input. The Channel C input performance is equivalent to front-panel performance for the same input. Performance specifications for the Channel C input can be found under Input Specifications in appendix E, "Specifications." Channel C is a 50 $\Omega$  input.

## Frequency Standard

The HP 5372A can operate with an internal or external frequency standard. The internal time base is a 10 MHz high-performance, ovenized crystal oscillator.

### EXTERNAL INPUT

This is a BNC connector that provides for the connection of a house standard frequency source to the HP 5372A. This input frequency is used in place of the internal 10 MHz ovenized time base. The acceptable input frequencies are: 1 MHz, 2 MHz, 5 MHz, and 10 MHz. Refer to appendix E for the acceptable signal levels.

Whenever a frequency standard change is made, that is, connecting an external frequency standard to take the place of the internal time base or switching back to the internal time base by removing the external signal, the HP 5372A stops making measurements. Measurements will only resume after the user acknowledges the time base change by pressing the Restart key. A status message will appear at the top of the display with this message, "Alternate Time Base selected. Press Restart."

### OUTPUT

This BNC connector provides a buffered 10 MHz output whether the HP 5372A is using an internal or external frequency source. This signal allows synchronizing another instrument to the time base used by the HP 5372A. When a signal is connected to the External Input, the 10 MHz output is derived from the external signal.

## GATE OUTPUTS

Two BNC connectors provide signals that indicate when measurement samples occur. These falling-edge signals are designated as Gate 1 and Gate 2 outputs. The outputs can be used to trigger other instruments. These outputs are active during Inhibited measurements. Listed below are the available Gate 1 and Gate 2 signals for the listed measurement/arming modes.

### NOTE

---

*Gate Output signals will not equal the resolution of the measurement results. Refer to appendix E, "Specifications," for the performance characteristics of these output signals.*

---

### **Time Interval**

Refer to chapter 1, "Time Interval Measurements", for a detailed timing diagram for each of the arming modes available for Time Interval measurements.

For the following arming modes, the falling edges at Gate 1 and Gate 2 correspond to the point at which time interval samples are acquired. An edge at the start of a time interval occurs at Gate 1. An edge at the end of a time interval occurs at Gate 2.

- Automatic
- Edge Holdoff
- Time Holdoff
- Event Holdoff
- Interval Sampling
- Repetitive Edge
- Random Sampling
- Edge/Interval
- Edge/Random

### **Continuous Time Interval**

Refer to chapter 1, "Time Interval Measurements," for a detailed timing diagram for each of the arming modes available for Continuous Time Interval measurements.

For the following arming modes, the falling edges at Gate 2 correspond to when the Continuous Time Interval samples are acquired. Each time a measurement sample is taken, Gate 2 will output a falling edge.

- Automatic
- Edge Holdoff
- Time Holdoff
- Event Holdoff
- Interval Sampling
- Repetitive Edge
- Edge/Interval

### **± Time Interval**

Refer to chapter 1, "Time Interval Measurements," for a detailed timing diagram for each of the ± Time Interval arming modes.

For the following arming modes, the falling edges at Gate 1 and Gate 2 correspond to when the ± Time Interval samples are acquired. An edge at the start of a time interval occurs at Gate 1. An edge at the end of a time interval occurs at Gate 2.

- Automatic
- Edge Holdoff
- Interval Sampling
- Parity Sampling
- Repetitive Edge
- Repetitive Edge/Parity
- Random Sampling
- Edge/Interval
- Edge/Event
- Edge/Parity
- Time/Time
- Event/Event
- Edge/Random

## Frequency and Period

The gate outputs are the same for Frequency and Period measurements. Refer to chapter 2, "Frequency/Period Measurements," for a detailed timing diagram for each of the Frequency and Period arming modes.

For the following arming modes, Gate 1 (Channel A) and Gate 2 (Channel B) are active for two-channel measurements; only Gate 2 is active for one-channel measurements. In either case, falling edges at the gate output correspond to when samples are acquired.

- Automatic
- Interval Sampling
- Edge Sampling
- Edge/Interval

For the following arming modes, only Gate 2 is active. Falling edges at Gate 2 correspond to when measurement samples are acquired.

- Edge Holdoff
- Time Holdoff
- Event Holdoff
- Cycle Sampling
- Edge/Cycle
- Edge/Edge
- Time/Interval
- Event/Interval

For the following arming modes, Gate 1 and 2 are active. Falling edges at Gate 1 and 2 correspond to when measurement samples are acquired. An edge at the start of a measurement occurs on Gate 1. An edge at the end of a measurement occurs on Gate 2.

- Time Sampling
- Edge/Time
- Edge/Event
- Time/Time
- Event/Event

**Totalize**

Refer to chapter 3, "Special-Purpose Measurements," for a detailed timing diagram for each of the Totalize arming modes.

For the following arming modes, Gate 2 is active. The falling edges at the Gate 2 output correspond to when the measurement samples are acquired.

- Interval Sampling
- Edge Sampling
- Edge/Interval
- Edge/Edge
- Time Interval

For the following arming mode, Gate 1 and 2 are active. The falling edges at Gate 1 and 2 correspond to when measurement samples are acquired. An edge at the start of a measurement occurs at Gate 1. An edge at the end of a measurement occurs at Gate 2.

- Externally Gated
- Manual

**Rise/Fall Time,  
Pos/Neg Pulse Width,  
Duty Cycle, Phase**

Refer to chapter 3, "Special-Purpose Measurements," for a detailed timing diagram for each of the arming modes.

For the following arming mode, the falling edges at Gate 1 and Gate 2 correspond to the time interval of the measurement being acquired. An edge at the start of the interval occurs at Gate 1. An edge at the end of the interval occurs at Gate 2.

- Automatic

## ARM DELAY OUTPUTS

Two BNC connectors provide signals that indicate when arming conditions have been satisfied. For example, a time holdoff arming condition is satisfied when the specified time has elapsed. A falling edge occurs at one of these outputs at the completion of an arming condition. The outputs can be used to trigger other instruments. These outputs are active during Inhibited measurements. Refer to appendix E, "Specifications," for the performance characteristics of these output signals.

Listed below are the available Arm Delay 1 and Arm Delay 2 signals for the arming modes. This description assumes you are familiar with the first five chapters of this manual. It is there that the principles of arming and its application to the different measurement functions are explained.

### Automatic

There is a falling edge at Arm 1 when the block holdoff condition is satisfied. For Automatic arming, this is generated by the HP 5372A.

There is a falling edge at Arm 2 every time the sample arm condition is satisfied before each sample is acquired.

### Edge Holdoff

There is a falling edge at Arm 1 when the block holdoff condition is satisfied.

### Time Interval

Refer to chapter 1, "Time Interval Measurements," for a detailed timing diagram for each of the Time Interval arming modes.

For the following arming mode, there will be a falling edge at Arm Delay 2 at the completion of the specified block holdoff time.

- Time Holdoff

For the following arming mode, there will be a falling edge at Arm Delay 2 at the completion of the specified number of block holdoff events.

- Event Holdoff

### **Continuous Time Interval**

Refer to chapter 1, "Time Interval Measurements," for a detailed timing diagram for each of the Continuous Time Interval arming modes.

For the following arming mode, there will be a falling edge at Arm Delay 2 at the completion of the specified block holdoff time.

- Time Holdoff

For the following arming mode, there will be a falling edge at Arm Delay 2 at the completion of the specified number of block holdoff events.

- Event Holdoff

### **± Time Interval**

Refer to chapter 1, "Time Interval Measurements," for a detailed timing diagram for each of the ± Time Interval arming modes.

For the following arming mode, there will be a falling edge at Arm Delay 1 at the completion of the specified number of stop arm events.

- Edge/Event

For the following arming mode, there will be a falling edge at Arm Delay 1 at the completion of the start arm time; there will be a falling edge at Arm Delay 2 at the completion of the stop arm time.

- Time/Time

For the following arming mode, there will be a falling edge at Arm Delay 1 at the completion of the start arm events; there will be a falling edge at Arm Delay 2 at the completion of the stop arm events.

- Event/Event

### **Frequency and Period**

Refer to chapter 3, "Frequency/Period Measurements," for a detailed timing diagram for each of the Frequency and Period arming modes.



For the following arming modes, there will be a falling edge at Arm Delay 1 at the completion of the specified stop arm time.

- Time Sampling
- Edge/Time

For the following arming mode, there will be a falling edge at Arm Delay 1 at the completion of the specified number of stop arm events.

- Edge/Event (Frequency only)

For the following arming mode, there will be a falling edge at Arm Delay 2 at the completion of the specified block holdoff time.

- Time/Interval

For the following arming mode, there will be a falling edge at Arm Delay 1 at the completion of the start arm time; there will be a falling edge at Arm Delay 2 at the completion of the stop arm time.

- Time/Time

For the following arming mode, there will be a falling edge at Arm Delay 2 at the completion of the specified number of block holdoff events.

- Event/Interval

For the following arming mode, there will be a falling edge at Arm Delay 1 at the completion of the start arm events; there will be a falling edge at Arm Delay 2 at the completion of the stop arm events.

- Event/Event

## INHIBIT INPUT

This high-impedance input can be used to control when the HP 5372A acquires measurements. By enabling Inhibit on the Pre-trigger menu, it is possible to prevent the HP 5372A from storing measurement data.



### TECHNICAL COMMENT

---

*One possible application of Inhibit is in measuring data from a disk drive sector. The Inhibit input can be used to prevent measuring the header information in the sector. Another application is to use the Inhibit input to avoid making measurements between bursts of pulsed frequency signals.*

---

The Inhibit feature is enabled, and the parameters of the inhibit signal are set, on the Pre-trigger menu. The conditions for the controlling signal can be set to above or below, 0.0 V (GND), 1.4 V (TTL), or -1.3 V (ECL). More information on the Inhibit feature can be found in chapter 10, "Pre-trigger Menu."

### NOTE

---

*There is up to a 50 ns delay between the point when Inhibit is enabled at the rear-panel input and when the storage of measurement data is suppressed.*

---

## TIME INTERVAL DETECT

This output provides a TTL low when a measured time interval falls above or below a specified time interval value; inside or outside of a range of specified time interval values. The detect feature is enabled, and the conditions are set, on the Pre-trigger menu. A TTL high is output otherwise.

The TI Detect feature is only available when making time interval measurements:

- Time Interval — a TTL low is output for every time interval that satisfies the TI Detect conditions.
- $\pm$  Time Interval — a TTL low is output for every time interval that satisfies the TI Detect conditions.
- Continuous Time Interval — the output will stay low for the entire period of time the measurements are outside the specified range, if the rate of time intervals is above 10 MHz. For this reason, do not use the output to count the number of time intervals that satisfy the TI Detect

conditions when making Continuous Time Interval measurements at these rates. At lower rates, a TTL low is output for every time interval satisfying the TI Detect conditions.

- Histogram Measurements — The TI Detect range values are determined by the Histogram boundaries.

**NOTE**

---

*The TI Detect output signal will go low no more than 600 ns after a time interval occurs that satisfies the TI Detect conditions. The signal will go high when a measured time interval does not satisfy the TI Detect conditions or the measurement sequence is completed.*

---

**FastPort (Option 020)**

This option consists of three rear-panel 40-pin connectors that provide access to raw, unprocessed time and event data. The data is output at high speed to an external memory system. All measurement result calculations and analysis are done in a host computer. There is a separate document that describes the FastPort feature.



# HP 5372A Front Panel Features

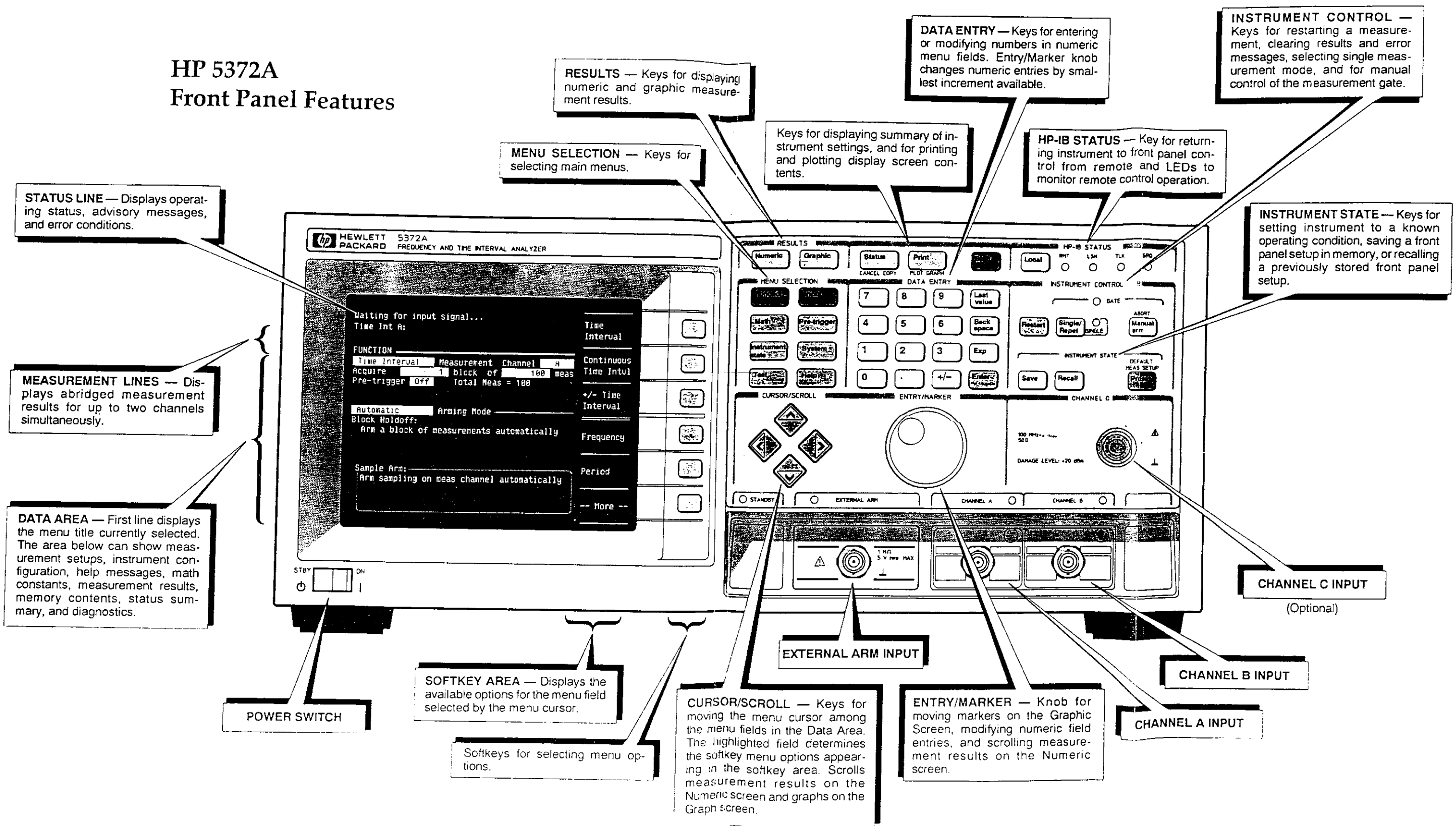

Figure 6-1. Front Panel Features



# HP 5372A Rear Panel Features

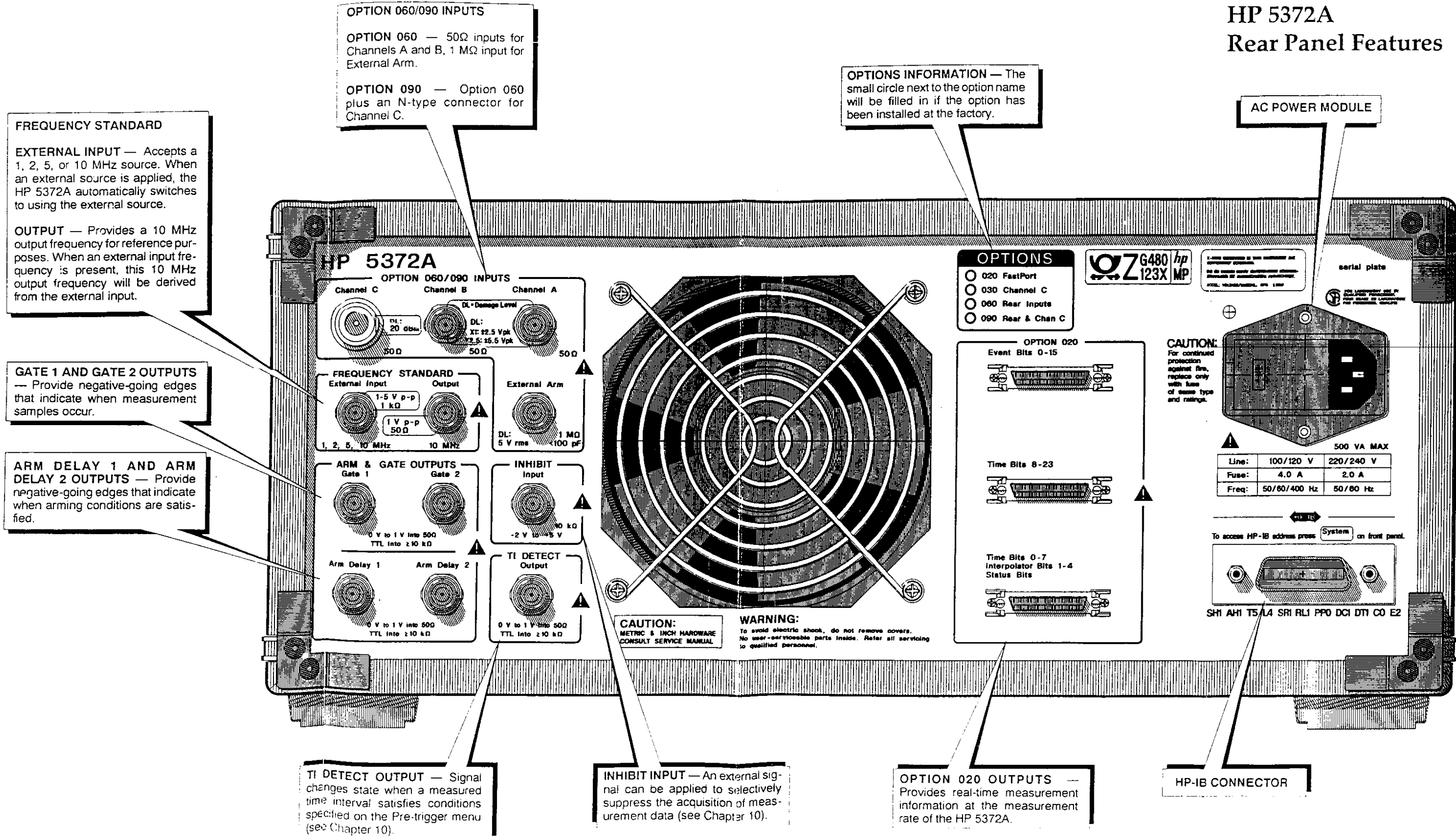

Figure 6-2. Rear Panel Features





## Contents of Chapter

---

Chapter Overview .....	7-1
Measurement Field .....	7-2
Channel Field .....	7-3
Block Field and Meas Field .....	7-4
Measurements and Pre-trigger .....	7-6
Measurements with Pre-trigger Off .....	7-7
1 Block of N Measurements .....	7-8
M Blocks of N Measurements / All Results .....	7-10
M Blocks of N Measurements / Not All Results .....	7-12
M Blocks of N Measurements / Averaged Results .....	7-14
Measurements with Pre-trigger On .....	7-15
Single Block of N Measurements / Pre-trigger .....	7-16
Multiple Blocks of N Measurements / Pre-trigger .....	7-18
Arming Mode Field .....	7-19



## FUNCTION MENU

### CHAPTER OVERVIEW

While the Function menu is displayed, the following parameters can be set:

- Measurement function (Time Interval, Frequency, etc.)
- Measurement channel(s)
- Number of blocks
- Number of measurements per block
- Pre-trigger
- Arming mode

Figure 7-1.  
Function Menu Screen

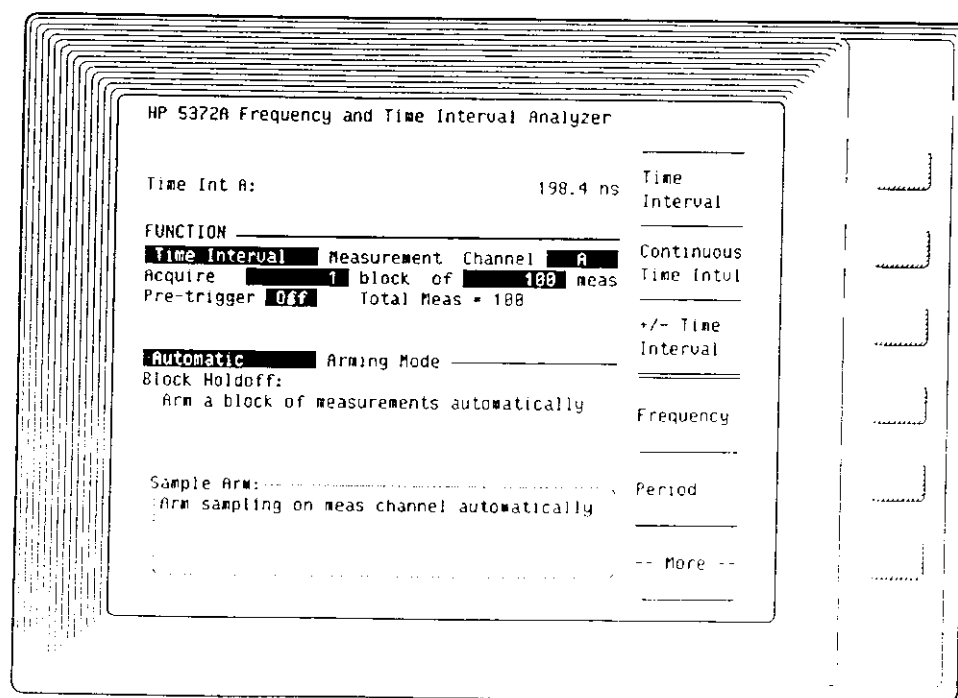

**MEASUREMENT  
FIELD**

The measurement field allows selection of the measurement function.

The measurement functions for the HP 5372A are:

- Time Interval
- Continuous Time Interval
- $\pm$  Time Interval
- Frequency
- Period
- Totalize
- Rise Time
- Fall Time
- Positive Pulse Width
- Negative Pulse Width
- Duty Cycle
- Phase
- Phase Deviation
- Time Deviation
- Peak Amplitude
- Histogram Time Interval
- Histogram Continuous Time Interval
- Histogram  $\pm$  Time Interval

**NOTE**

---

*Since the measurement configuration and features available with the Histogram measurements are somewhat unique, these measurement functions are described in chapter 4, "Histogram Measurements." There will be only minor references to Histogram measurements in this chapter. The three Histogram measurements use special hardware in the HP 5372A that allows measurements to be histogrammed very quickly.*

---

**Softkey Options:**

Time Interval | Continuous Time Intvl |  $\pm$  Time Interval  
Frequency | Period | Totalize | Rise Time | Fall Time  
Pos Pulse Width | Neg Pulse Width | Duty Cycle  
Phase | Phase Deviation | Time Deviation | Peak Amplitude  
Histogram Time Interval | Histogram Continuous TI  
Histogram  $\pm$  Time Interval

**HP-IB Parameters:**

TINT | CTIN | PMT  
 FREQ | PER | TOT | RTIM | FTIM  
 PWID | NWID | DUTY  
 PHAS | PDEV | TDEV | PEAK  
 HTIM | HCT | HPMT

**Comments:**

Not all measurement channel and arming mode combinations are available for all measurements. Consult chapter 1, 2, or 3 for a listing of the channel/arming combinations available for the measurement you want to make.

There is interaction between the different fields on this menu. The measurement selection determines the available channel options. The measurement and channel selection determines the available arming modes.

**CHANNEL FIELD**

The Channel field allows selection of the input channel, or channels, upon which to make the measurement.

**Softkey Options for Channels A and B:**

A, B, A & B, A / B, B / A, A + B, A - B, B - A, A → B, B → A,  
 A rel B, B rel A

**HP-IB Parameters for Channels A and B:**

A, B, (A ^ B), (A / B), (B / A), (A + B), (A - B), (B - A), (A > B), (B > A),  
 (A < B), (B < A)

**Softkey Options for Channel C (Option 030):**

C, A & C, B & C, C / A, C / B, A / C, B / C, A + C, B + C, C -  
 A, C - B, A - C, B - C

**HP-IB Parameters for Channel C (Option 030):**

C, (A ^ C), (B ^ C), (C / A), (C / B), (A / C), (B / C), (A + C), (B + C),  
 (C - A), (C - B), (A - C), (B - C)

**Comments:**

The channel options available are dependent on the selected measurement function and arming mode. Not all channel options are available for all measurements. Only the available channel options for the selected measurement and arming mode will appear in the softkey area.

The Channel C input can only be used for Frequency and Period measurements.

**BLOCK FIELD AND  
MEAS FIELD**

These two fields are used to specify the total number of measurements to collect in a measurement sequence.

In the **block** field, specify the number of blocks you want to acquire. In the **meas** field, specify the number of measurements per block. The total number of measurements = (the number of blocks) x (the number of measurements per block).

**Options:**

Use the DATA ENTRY keypad to enter the number of blocks and the number of measurements in each block. Conclude the entry by pressing the **Enter** key. Current values can be modified using the ENTRY/MARKER knob. If you are in the single acquisition mode (the SINGLE LED is on), the **Enter** key or the **Restart** key must be pressed to initiate a new measurement sequence after using the knob to change a value. In the repetitive acquisition mode, setting a new value with the knob causes an update of the parameter value the next time a measurement acquisition restarts.

Block range = 1 to 99,999,999

Meas range = 1 to 8,191 (maximum)

The total number of measurements can equal 99,999,999 x 8191.

**NOTE**

---

*These limits do not apply to the three Histogram measurements. Histogram Time Interval, Histogram Continuous Time Interval, and Histogram  $\pm$  Time Interval functions allow a total number of measurements up to 2,000,000,000,000 (2E15). Refer to chapter 4, "Histogram Measurements" for details.*

---



## TECHNICAL COMMENT

With the exception of Histogram measurements (see chapter 4), there are 8,192 memory locations that can be used to store data collected in a single block, or multiple blocks. The number of measurements that fit in these 8K locations varies with measurement function, channel choices, and arming mode. For every configuration, the **meas** field value will automatically default to the maximum number of measurements that will fit in the 8K memory locations when you attempt to enter a value that exceeds the maximum. Use appendix A as a guide to selecting the maximum number of measurements that will fit in memory for some common measurement functions. The guide provides information for single or multiple block configurations. When all measurements fit in memory, you have access to all the results for numeric or graphic review. The rest of this chapter explains the measurement setup options for size of measurement and what results and analysis features are available.

*Two examples of how the choice of function and arming sets the maximum number of measurements in a block —*

*The maximum number of measurements in one block of a Frequency, single channel, Automatic arming measurement = 8,191. (After the first measurement, each measurement requires only one sample.)*

*The maximum number of measurements in one block of a Time Interval, A channel, Automatic arming measurement = 4,096. (Each measurement requires a start sample and a stop sample.)*

---

### HP-IB Commands:

For the **block** field — BLOC <n>, where <n> = 1 to 99,999,999  
 For the **meas** field — MSIZ <n> or SSIZ <n> where <n> = 1 to 8,191 Max. (Value will default to the maximum for the selected function, channel, and arming mode when a value above the maximum is entered.)

## MEASUREMENTS AND PRE-TRIGGER

The HP 5372A provides two methods for specifying how to complete your measurement sequence:

- **Measurements with Pre-trigger Off** — Data collection begins when the initial arming conditions are satisfied, and terminates when the specified number of measurements have been collected.
- **Measurements with Pre-trigger On** — Data collection begins when the initial arming conditions are satisfied. A stream of data is collected continually into a “circular” buffer, that is, data is stored in measurement memory with the newest data overwriting the oldest data. When the pre-trigger event occurs, the measurement sequence completes according to the pre-trigger control settings on the Pre-trigger menu. The amount of pre-trigger data can be specified by a number of measurements or a percentage of measurements within a block. For example, a pre-trigger amount of 20% would specify that 80% of the measurements in the block will be acquired after the pre-trigger event. The pre-trigger event can be a signal applied to the External Arm input or a measured time interval using the TI Detect feature (also set on the Pre-trigger menu).

When data collection is completed, one block of data is processed into measurement results. The block of data is the one most recently acquired. If the pre-trigger event occurs before one complete block of data is collected, the instrument processes and displays less than a full block of results. For details about the Pre-trigger and TI Detect features beyond what is described in this chapter, review chapter 10, “Pre-trigger Menu.”

### **NOTE**

---

*The above discussion of measurements using Pre-trigger does not apply to Histogram measurements. For Histogram measurements using Pre-trigger, the pre-trigger amount is restricted to 100%. See chapter 4, “Histogram Measurements,” for more information.*

---



## Measurements with Pre-trigger Off

Measurement sequences with pre-trigger off will acquire the total number of measurements you have specified in the **block** and **meas** fields.

There are four configurations for measurements not using pre-trigger. Each is explained and includes what you can expect for results and analysis capabilities.



### TECHNICAL COMMENT

*As you will see in this section, not all of the measurement results may be saved in measurement memory, depending on the type of measurement you want to make and the number of measurements you specify. Even though individual measurement results may not be available, all results will be included in the Histogram graph. The Statistics feature when enabled will provide statistical values that include all the results, whether or not they fit into measurement memory. Additionally, for the measurement configurations that offer block averaging, all results will be included in the final averaged results.*

1 BLOCK OF N  
MEASUREMENTS

Figure 7-2.  
One Block — All  
Measurements Fit  
In Memory

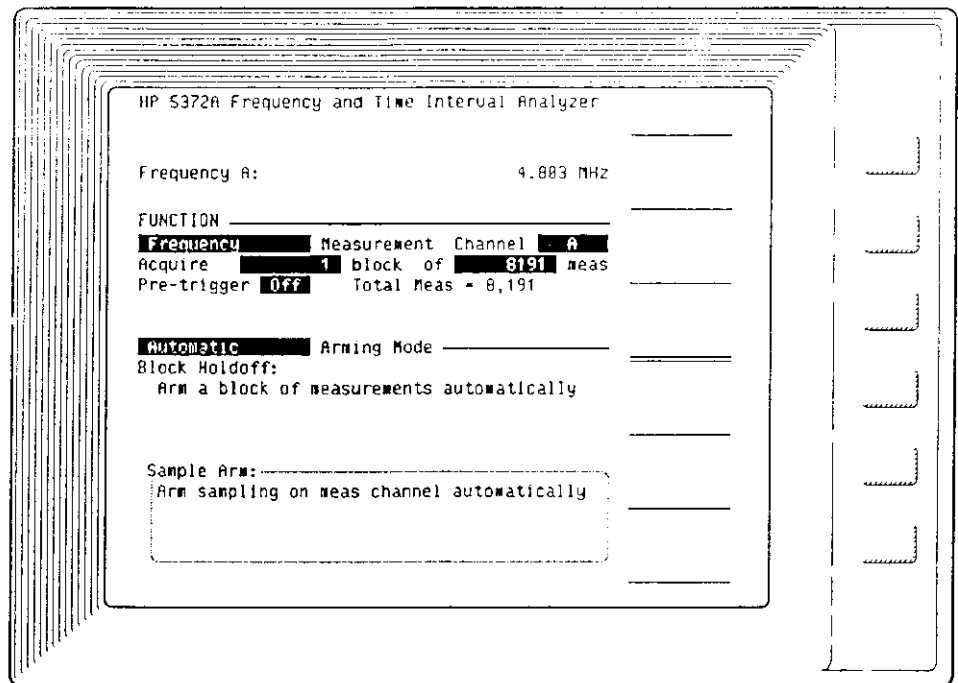

When the number of blocks is set to one, every measurement result will be stored in measurement memory and available for review. For the menu shown in *Figure 7-2*, the following results features are available:

- **On the Numeric Screens** — 8,191 measurement results can be displayed and included in statistics and limit testing.
- **On the Graphic Screens** — All graphic features supported for the measurement function selected (Frequency here) include the 8,191 measurement results.

- **Measurement Abort** — If the measurement sequence is aborted, data acquisition is immediately halted and the data that was collected before the abort is displayed. For information on the instrument conditions that allow the Abort feature to interrupt measurement sequences, refer to chapter 6, “Front Panel/Rear Panel.”
- **Appendix A** — Use appendix A as a guide for determining the maximum number of measurements per block for your single-block acquisition.

M BLOCKS OF N  
MEASUREMENTS / ALL  
RESULTS

Figure 7-3.  
M Blocks — All  
Measurements Fit  
In Memory

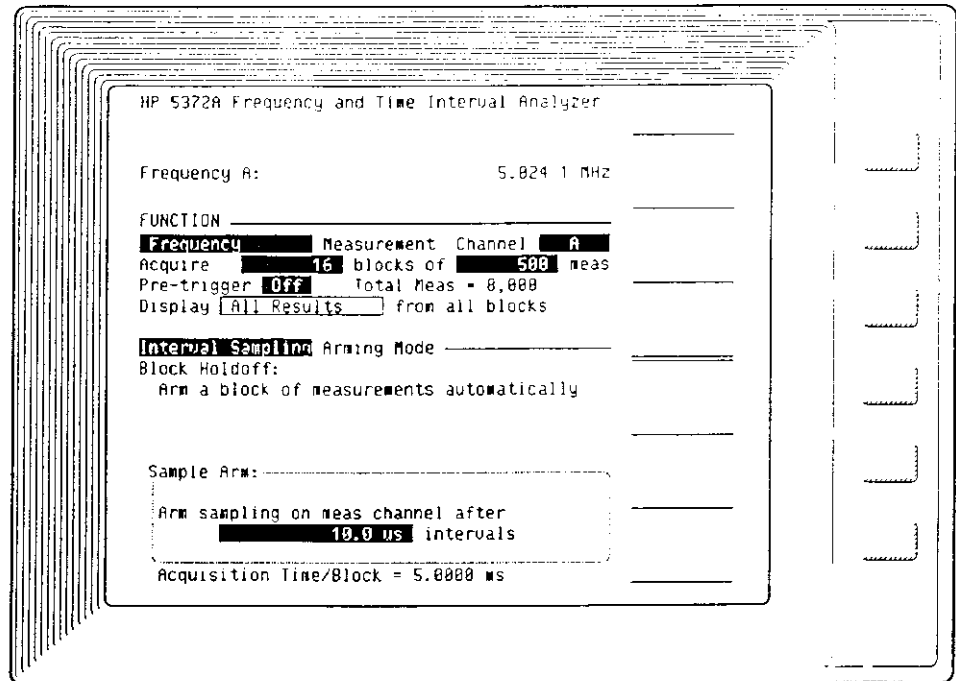

When the number of blocks is set greater than one, it is possible that not all measurements will fit into measurement memory. *Figure 7-3* shows an example where a multiple block measurement does fit in memory. The following results features are available for the menu shown in *Figure 7-3*:

- **On the Numeric Screens** — 8,000 measurement results can be displayed and included in statistics and limit testing.
- **On the Graphic Screens** — All graphic features supported for the measurement function selected (Frequency here) include the 8,000 measurement results.
- **Measurement Abort** — If the measurement sequence is aborted, data acquisition is immediately halted and the data that was collected before the abort is displayed. For information on the instrument conditions that allow the Abort feature to interrupt measurement sequences, refer to chapter 6, "Front Panel/Rear Panel."

- Appendix A — Use appendix A as a guide for determining the maximum number of measurements that will fit into memory for your multiple-block acquisition.



#### TECHNICAL COMMENT

---

Generally, the HP 5372A will clear the measurement memory before acquiring a new block of measurements. Consequently, only the last block of data can be reviewed and analyzed. However, if the total number of measurements from a multiple-block acquisition can fit in memory, the HP 5372A will automatically segment its measurement memory to store all the measurements. All measurements are available for review and analysis. When memory segmentation is used, the time between blocks of measurements is minimized ( $<2 \mu\text{s}$ ).

Note that over HP-IB, using the WTS command (Wait To Send), it is possible to retrieve each block of data before the measurement sequence continues. Refer to the Programming Manual for details.

---

M BLOCKS OF N  
MEASUREMENTS / NOT ALL  
RESULTS

Figure 7-4.  
M Blocks —  
Measurements Do Not  
All Fit In Memory

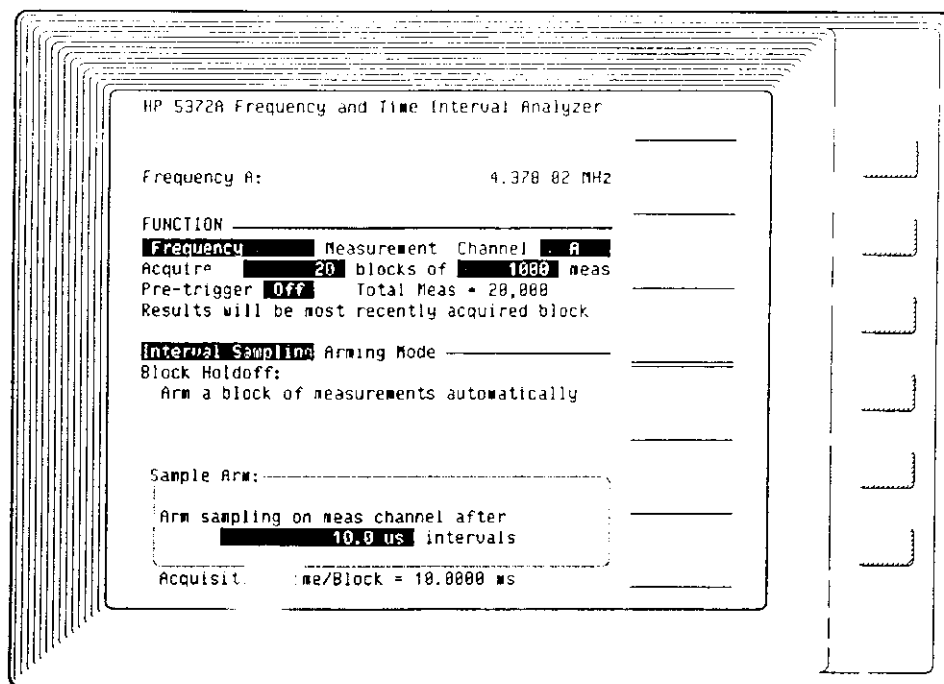

With the number of blocks set greater than one, and the number of measurements per block set so the total number of measurements exceeds the size of measurement memory, the following line of text will appear on the Function menu, "Results will be most recently acquired block." Figure 7-4 shows an example of this situation. The following results are available for the menu shown in Figure 7-4:

- **On the Numeric Screens** — 1,000 measurement results (the last block acquired) can be displayed. If the Statistics feature was enabled on the Math menu prior to the measurement sequence, all 20,000 measurements would be included in the statistics. If Statistics is enabled after a measurement sequence has completed, a new measurement will be initiated.
- **On the Graphic Screens** — The Histogram graph includes the entire measurement acquisition, 20,000 measurements. The Time Variation graph, and the Event Timing graph (if available), will display only the last block of data (1,000 measurements here).

- **Measurement Abort** — If the measurement sequence is aborted, data acquisition is immediately halted and data that was collected before the abort is displayed according to these rules:
  1. If the acquisition was interrupted between blocks:
    - Numeric results show only the last acquired block of data.
    - Histogram graph shows all measurements collected up to the abort.
    - Time Variation and Event Timing graphs show only the last acquired block of data.
  2. If the acquisition was interrupted during a block:
    - Numeric results show only the portion of the last block up to the abort.
    - Histogram graph shows all measurements collected up to the abort.
    - Time Variation and Event Timing graphs show only the portion of the last block up to the abort.
- **Appendix A** — Use appendix A as a guide for determining the maximum number of measurements that will fit into memory for your multiple-block acquisition.

M BLOCKS OF N  
MEASUREMENTS /  
AVERAGED RESULTS

Figure 7-5.  
M Blocks —  
Blocks Are Averaged

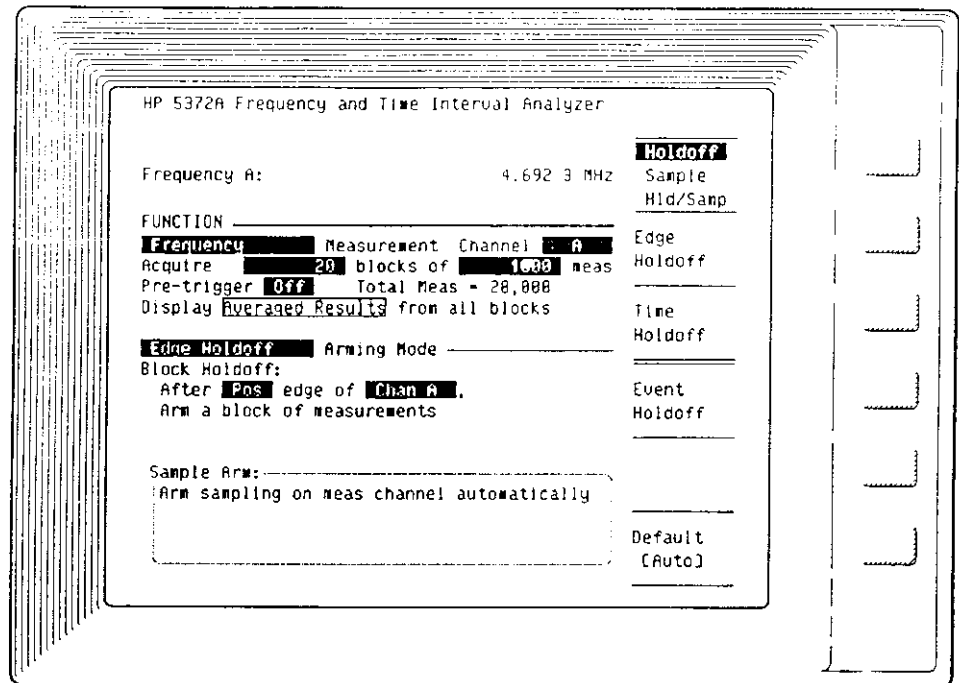

- Averaged results are provided from multiple blocks when you are making a Frequency or Period measurement with one of the following arming modes:

- Edge Holdoff
- Time Holdoff
- Event Holdoff
- Edge / Interval
- Edge / Cycle
- Time / Interval
- Event / Interval

OR you are making a Continuous Time Interval measurement with one of the following arming modes:

- Edge Holdoff
- Time Holdoff
- Event Holdoff
- Edge / Interval

OR you are making a Phase Deviation or Time Deviation measurement with one of the following arming modes:



- Edge Holdoff
- Edge/Interval (see chapter 3)

For the menu shown in *Figure 7-5*, the following results features are available:

- “Averaged Results from all blocks” indicates that the measurement function and arming mode combination will provide averaging. The way this works is that the first measurement of each of the blocks is averaged, the second measurement of each of the blocks is averaged, and so on to 1,000 for the measurement shown.
- **On the Numeric Screens** — 1,000 results can be displayed. Each one is the average of 20 measurements. If the Statistics feature was enabled on the Math menu prior to the measurement sequence, all 20,000 measurements would be included in the statistics. If Statistics is enabled after a measurement sequence has completed, a new measurement will be initiated. The limit testing feature operates similarly to Statistics in this configuration. The statistics are calculated on the individual results, while limit testing is on the averaged values.
- **On the Graphic Screens** — The Histogram graph includes the entire measurement acquisition, 20,000 measurements. The Time Variation graph will display one block of averaged results. The Event Timing graph (if available for the measurement function) will show one block of 1,000 averaged results.
- **Measurement Abort** — If the measurement sequence is aborted, data acquisition is halted at the end of the block being acquired at the time the abort is executed. The data that was collected before the abort is displayed. For information on the instrument conditions that allow the Abort feature to interrupt measurement sequences, refer to chapter 6, “Front Panel/Rear Panel.”

### Measurements With Pre-trigger On

Measurement sequences with Pre-trigger on can be executed on single or multiple blocks of measurements. Measurement data will be collected as determined by the pre-trigger control settings on the Pre-trigger menu. The IIP 5372A can monitor measurement data and then capture data that occurs prior to, and following, the pre-trigger event.

TECHNICAL COMMENT

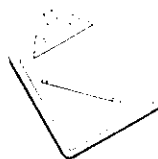

It is possible that less than the number of measurements you specify in the **meas** field will be collected when the pre-trigger event causes the measurement sequence to end before all measurements have been collected. This happens when the pre-trigger event occurs before the specified amount of pre-trigger data has been collected. For example, if the pre-trigger amount is set to 60% and the pre-trigger event occurs at the start of a measurement sequence, only the post-trigger amount of the measurement total (40%) will be acquired before the measurement sequence ends. So, with the pre-trigger amount set to 60% and a measurement size of 1,000, the HP 5372A acquires the 400 measurements that occur after the pre-trigger event.

SINGLE BLOCK OF N MEASUREMENTS / PRE-TRIGGER

Figure 7-6. Single Block — Measurements Specified By Pre-trigger

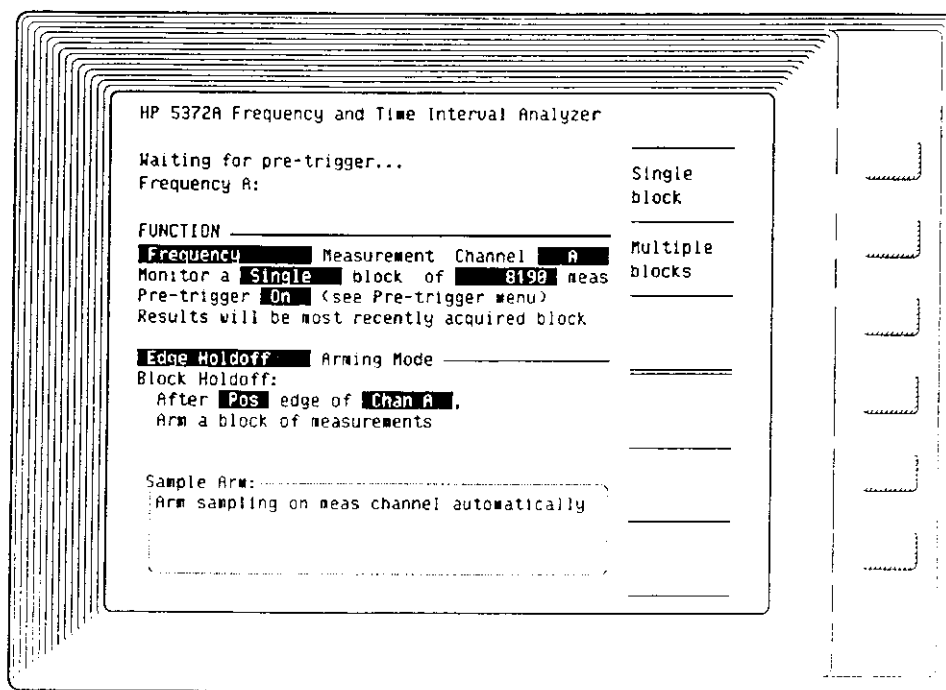

- Pre-trigger is only available for continuous arming modes (Block Holdoff / Sample Arm). Refer to chapter 5, "Arming," for more information on continuous arming modes.

- The block holdoff condition is satisfied only once and then samples are collected and may overwrite the block start data. This occurs when the amount of data monitored (and collected) exceeds the size of measurement memory. Consequently, the results display may show the block start followed by measurements, or may show only measurements. If the pre-trigger event terminates acquisition before the pre-trigger amount (specified as a number of samples or a percentage of the total acquisition) is collected, then less than the specified pre-trigger amount is collected and displayed.
- The number of measurements that will be collected prior to the pre-trigger event is set by the user on the Pre-trigger menu (see chapter 10, "Pre-trigger Menu"). The number may not exceed the number of measurements in the block, and will be reduced automatically if it is too large.

For the menu shown in *Figure 7-6*, the following results features are available:

- **On the Numeric screens** — Up to 8,190 measurements (one block of data) that were collected around the pre-trigger event can be displayed. Statistics and limit testing are available.
- **On the Graphic Screens** — The graphs will include the one block of data that was collected around the pre-trigger event. That is, the data that was monitored prior to, and collected after, the pre-trigger event.
- **Measurement Abort** — If the measurement sequence is aborted, data acquisition is immediately halted and the data that was collected before the abort is displayed. For information on the instrument conditions that allow the Abort feature to interrupt measurement sequences, refer to chapter 6, "Front Panel/ Rear Panel."

MULTIPLE BLOCKS OF N  
MEASUREMENTS /  
PRE-TRIGGER

Figure 7-7.  
Multiple Blocks —  
Measurements Specified By  
Pre-trigger

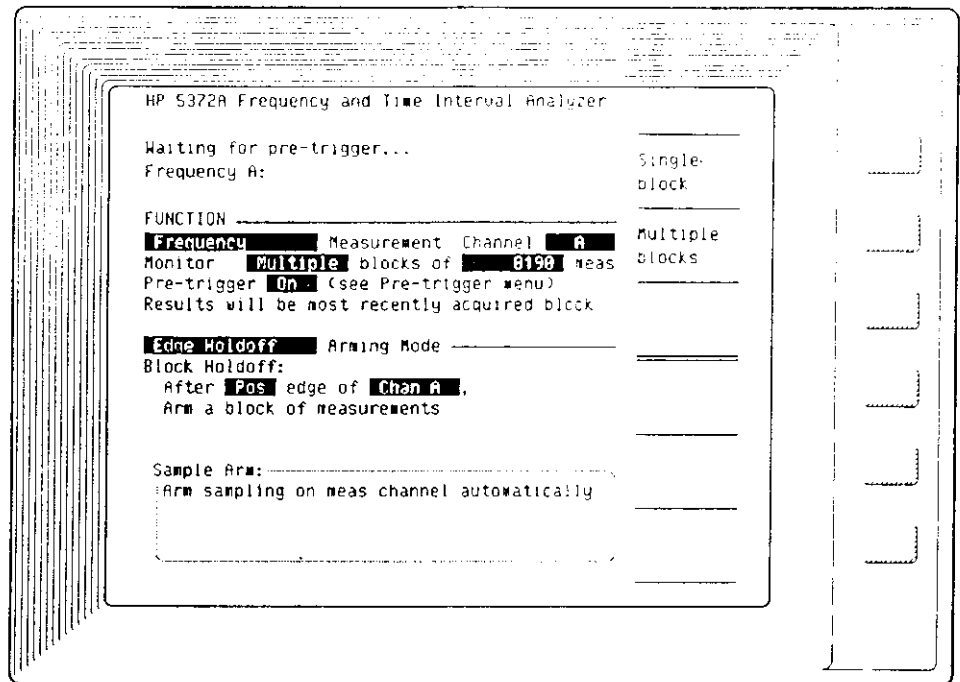

- Pre-trigger is only available for continuous arming modes (Block Holdoff / Sample Arm). Refer to chapter 5, "Arming," for more information on continuous arming modes.
- The block holdoff condition must be repeated after the collection of each block of measurements. As samples are collected, a new block starts and new data progressively overwrite old block starts and data. Consequently, the results display may show a block start followed by measurements, or it may show measurements from one block followed by a block start and measurements from the next block. If the pre-trigger condition terminates acquisition before the pre-trigger amount (specified as a number of samples or a percentage of the total acquisition) is collected, then less than the specified pre-trigger amount is collected and displayed.
- The number of measurements that can be collected prior to the pre-trigger event is set by the user on the Pre-trigger menu (see chapter 10, "Pre-trigger Menu"). The number

may not exceed the number of measurements in the block, and will be reduced automatically if it is too large.

For the menu shown in *Figure 7-7*, the following results features are available:

- **On the Numeric screens** — Up to 8,190 measurements (one block of data) that were collected around the pre-trigger event can be displayed. Statistics and limit testing are available.
- **On the Graphic Screens** — The graphs will include the one block of data that was collected around the pre-trigger event. That is, the data that was monitored prior to, and collected after, the pre-trigger event.
- **Measurement Abort** — If the measurement sequence is aborted, data acquisition is immediately halted and the data that was collected before the abort is displayed. For information on the instrument conditions that allow the Abort feature to interrupt measurement sequences, refer to chapter 6, “Front Panel/ Rear Panel.”

## ARMING MODE FIELD

The method used for arming the measurement, sampling data, and ending the measurement is set in the arming mode field and the data area below this field. The arming modes are listed below with the HP-IB command for each. For detailed information on each arming condition, refer to chapter 5, “Arming.”

### Softkey Options:

Automatic

Holdoff modes—

Edge Holdoff | Time Holdoff | Event Holdoff

Sampling Modes—

Interval Sampling | Time Sampling | Cycle Sampling  
Edge Sampling | Parity Sampling | Repetitive Edge  
Repetitive Edge-Parity | Random Sampling

Holdoff/Sampling modes—

Edge/Interval | Edge/Time | Edge/Edge | Externally Gated  
Edge/Cycle | Edge/Event | Edge/Parity | Edge/Random  
Time/Interval | Time/Time | Event/Interval  
Event/Event | Manual

**HP-IB Parameters:**

AUT

Holdoff modes—

EDH | THOL | EVH

Sampling Modes—

ISAM | TSAM | CSAM  
ESAM | PSAM | REDG  
RPAR | RSAM

Holdoff/Sampling modes—

EDIN | EDT | EDED | EGAT  
EDCY | EDEV | EDP | ERAM | TINT  
TTIM | EVIN | EVEV | MAN

00000

8 INPUT MENU





## Contents of Chapter

---

Chapter Overview .....	8-1
Input Channels Field .....	8-2
Trigger Event Fields .....	8-3
Trigger Slope .....	8-4
Trigger Mode .....	8-4
Manual Trigger .....	8-4
Single Auto Trigger .....	8-5
Repetitive Auto Trigger .....	8-5
Trigger Level .....	8-6
Trigger Level Numeric Summary .....	8-7
External Arm Level Field .....	8-7
Input Pods .....	8-7
Input Pod Characteristics .....	8-8
Bias Level Field .....	8-8
Attenuation Field .....	8-9
Channel C (Option 030) Attenuation Field .....	8-10
Hysteresis Field .....	8-11



## INPUT MENU

### CHAPTER OVERVIEW

While the INPUT screen is selected, the following parameters can be set:

- Separate or Common mode for Channel A and B
- Trigger event slope, mode, and level for Channel A and B
- Trigger level for External Arm signal
- Bias level and attenuation for Channel A and B
- Attenuation for the optional C Channel
- Hysteresis for Channel A and B

Figure 8-1.  
Input Menu Screen

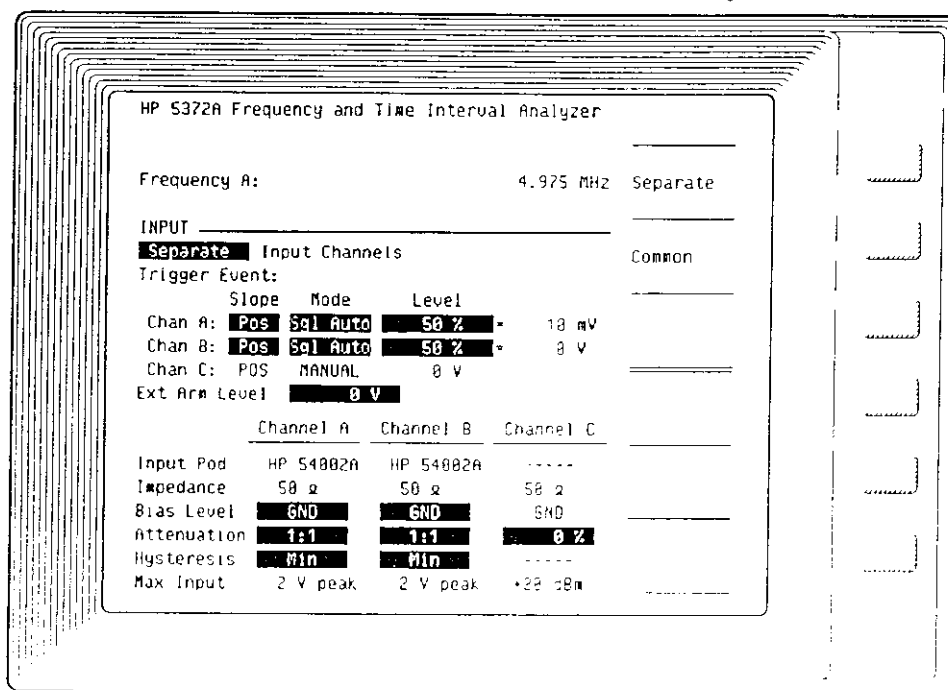

**INPUT CHANNELS FIELD**

The standard input channels are Channel A and Channel B. The Input Channels field can be set to Separate or Common.

**Separate:** The Channel A and B input signals are connected to their respective input circuitry as shown in in *Figure 8-2*.

*Figure 8-2.  
Separate Mode Input Configuration*

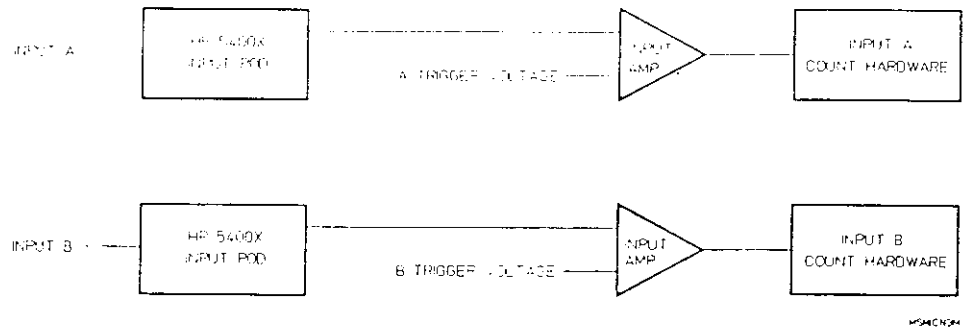

**Common:** The Channel A input signal is also routed to the Channel B input circuitry, bypassing the Channel B input pod and attenuator. Any signal connected to Channel B will be terminated and attenuated as specified on the Input menu for Channel B. *Figure 8-3* shows the Common Mode configuration.

*Figure 8-3.  
Common Mode Input Configuration*

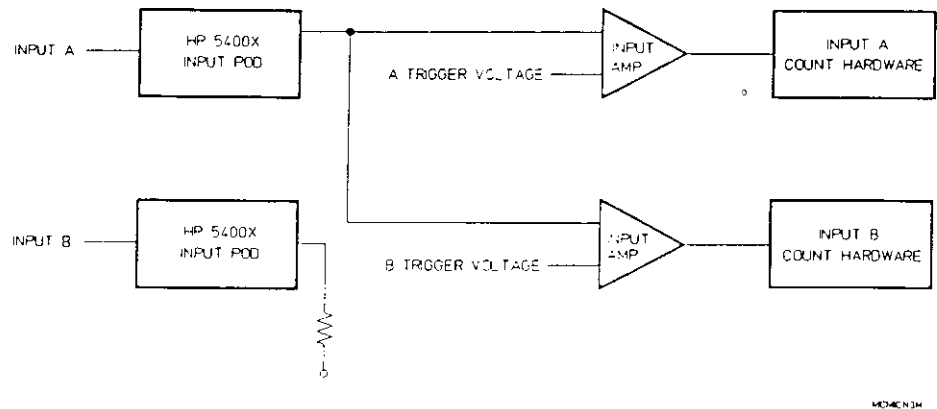

---

**NOTE**

---

*When the Input Channels field is set to Common, the limits for the Channel B Trigger Event parameters (slope, mode, and level settings) are determined by the input pod installed at Channel A and the attenuation setting for Channel A. Set these Channel B parameters as required for the signal connected at Channel A.*

---

**Softkey Options:**

Separate, Common

**HP-IB Command:**

MOD {SEP | COM}

**Comments:**

The Separate/Common circuitry is buffered so that neither input impedance nor input sensitivity is affected by the Input Channels setting.

The Common input mode is automatically invoked for Rise/Fall Time, Positive/Negative Pulse Width, and Duty Cycle measurements.

**TRIGGER EVENT  
FIELDS**

The trigger event is defined in three menu fields:

- Slope field
- Mode field
- Level field

The trigger event is the Channel A or Channel B event upon which measurements start, sample, and stop. It is defined for the A and B channels by setting a trigger slope, a trigger mode, and a trigger level for each channel.

**Trigger Slope**

The slope setting determines whether the trigger point will be on a rising or falling input voltage. Triggering occurs when the input signal reaches the selected voltage on the selected slope. The “Positive” setting specifies that the trigger point will be on a rising voltage. Likewise, the “Negative” setting specifies that the trigger point will be on a falling voltage.

**Softkey Options:**

Pos, Neg

**HP-IB Command:**

SLOP {POS | NEG}

**Trigger Mode**

Trigger mode is the method the HP 5372A uses to set the trigger level. There are three options:

- Manual Trigger
- Single Auto Trigger
- Repetitive Auto Trigger

**NOTE**

---

*The operating range of the auto trigger modes (Single Auto and Repetitive Auto) is 1 kHz to 200 MHz. For input frequencies greater than 200 MHz, auto triggering modes are functional, but accuracy specifications are not guaranteed.*

---

**MANUAL TRIGGER**

When the Manual trigger mode is selected, the trigger level voltage is specified by entering a numeric value in the “Level” field. The default value is 0 V dc. Values can be entered using the softkeys, the DATA ENTRY keypad, or the ENTRY/MARKER knob.

1:1 Attenuation Range = -2.0 V dc to +2.0 V dc in 2 mV steps

2.5:1 Attenuation Range = -5.0 V dc to +5.0 V dc in 5 mV steps

**SINGLE AUTO TRIGGER** When you select Single Auto Trigger to set the trigger level, the input signal will have its peak amplitudes measured, and the trigger level will be set to a percentage of the peak-to-peak voltage value according to the following formula:

$$\text{Trigger point} = \text{minimum peak} + (\text{maximum peak} - \text{minimum peak}) \times \text{percentage}$$

The percentage is specified in the "Level" field. The Single Auto Trigger function sets the trigger level:

- whenever the Single Auto Trigger function is selected
- any time a measurement sequence restarts as a result of changing any parameter on the Function or Input menus
- whenever the **Restart** key is pressed
- prior to the start of every measurement sequence, when the Single/Repetitive acquisition mode is set to Single
- only prior to the first time a measurement sequence executes, when the Single/Repetitive acquisition mode is set to Repetitive (see illustration below.)

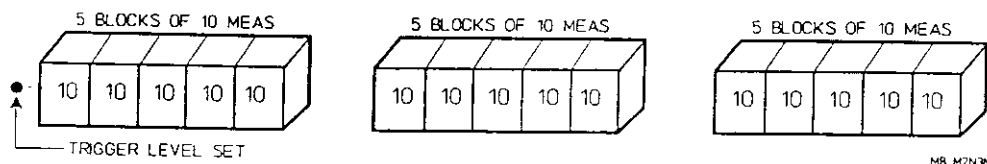

**REPETITIVE AUTO TRIGGER** If you select Repetitive Auto Trigger to set the trigger level, the input signal will have its peak amplitudes measured and the trigger level will be set to a percentage of the peak-to-peak voltage value just as for the Single Auto Trigger mode. The Repetitive Auto Trigger function sets the trigger level:

- whenever the Repetitive Auto Trigger function is selected
- any time a measurement restarts as a result of changing any parameter on the Function or Input menus
- whenever the **Restart** key is pressed
- prior to the start of every measurement sequence, when the Single/Repetitive acquisition mode is set to Single

- prior to the start of every measurement sequence, when the Single/Repetitive acquisition mode is set to Repetitive (see illustration below).

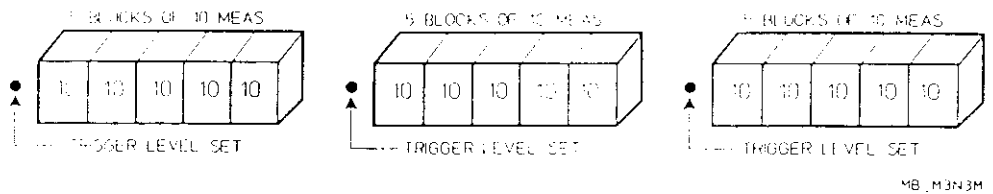

**NOTE**

*The Repetitive Auto Trigger function slows down the overall measurement rate because measurements cannot occur prior to setting the trigger level.*

**Softkey Options:**

Manual Trig | Single Auto Trig | Repetitive Auto Trig

**HP-IB Command:**

TRIG {MAN | SAUT | RAUT}

**Trigger Level**

The trigger level is the voltage at which the input signal will trigger the HP 5372A.

If either Single Auto or Repetitive Auto trigger modes are selected, a percentage (0 to 100%) can be entered to specify triggering at a particular point on the peak-to-peak slope of the input signal. The Analyzer sets the trigger level and displays the trigger voltage on the Input menu. The default percentage is 50%.

Select the Manual trigger mode, and a specific voltage value can be entered into the Level field using the softkeys, the numeric keypad, or the ENTRY/MARKER knob. Use the Enter key to complete the entry sequence from the keypad.



**Softkey Options:**

Manual: 0 V | TTL Preset [ 1.4 V] | ECL Preset [-1.3 V]

Single Auto: 50% | 20% | 80%

Repetitive Auto: 50% | 20% | 80%

**TRIGGER LEVEL  
NUMERIC SUMMARY**

For Auto Trigger modes, Enter —

0 to 100% in 1% steps. Default is 50%.

For Manual Trigger mode, Enter —

-2.0 V dc to +2.0 V dc (in 2 mV steps) for 1:1 Attenuation

-5.0 V dc to +5.0 V dc (in 5 mV steps) for 2.5:1 Attenuation

Default is 0 V dc.

**HP-IB Command:**

RLEV &lt;number&gt; (specify an auto trigger level percentage)

LEV &lt;number&gt; (specify a manual trigger level voltage)

**EXTERNAL ARM  
LEVEL FIELD**

The External Arm trigger level can be set from -5.0 Vdc to +5.0 Vdc in 20 mV steps. The default value for the External Arm trigger level is 0 V dc.

Range = dc coupled to 100 MHz

**Softkey Options:**

0 V | TTL Preset [ 1.4 V] | ECL Preset [-1.3 V]

**HP-IB Command:**

LEV &lt;number&gt;

**INPUT PODS**

The HP 5372A uses removable input pods that can be chosen according to the measurement application. This instrument recognizes which model pod is installed and displays the pod's model number and impedance. The termination impedance for the Channel A and B inputs is dictated by the specific input pod used.

---

**CAUTION**

---

*Do not remove an input pod while the HP 5372A is powered on. Always set Analyzer to Standby before removing or inserting an input pod. Damage to the pod can result from not following this caution.*

---

**Input Pod Characteristics**

The following descriptions summarize the characteristics and operating environments for each of the available input pods.

**■ HP 54002A 50 $\Omega$  BNC Input Pod**

This pod will terminate a 50 $\Omega$  coaxial cable. Two of these pods come standard with the HP 5372A. For the class of signals that exist in a 50 $\Omega$  environment, this pod provides low insertion loss and a good termination.

**■ HP 54001A 10-k $\Omega$ /2pF, 1 GHz Miniature Active Probe/Pod**

This probe pod is very useful for high-speed logic measurements where wide bandwidth is essential and capacitive loading dominates the probe's effect on the signal.

**■ HP 54003A 1-M $\Omega$ /8pF, 300 MHz, 10:1 Probe/Pod**

This probe pod is used to measure circuits that are sensitive to resistive loading (i.e., having resistances above a kilohm). These circuits are usually slow and not so sensitive to capacitive loading. The probe can be removed from the pod to provide a 1-M $\Omega$ , ~10 pF BNC input. This setup allows a coaxial connection in applications where bandwidth and capacitive load are not as critical as resistive loading.

**BIAS LEVEL FIELD**

For the 50 $\Omega$  standard input pod, either a 0 volt (GND) or a -2 V (ECL) termination voltage may be specified. The BNC input connector remains connected to ground. The -2 V termination preserves the characteristics of high-speed ECL circuits. When any other type of pod is installed, the GND termination is automatically selected, and the -2 V bias level is not available.

**Softkey Options:**

GND [ 0 V ] | ECL [-2 V]

HP-IB Command:

BIAS {GND | ECL}

## ATTENUATION FIELD

Increased attenuation allows the HP 5372A to measure a signal that would otherwise exceed the signal operating range of the instrument. It may also be used in some circumstances to improve the noise immunity of the measurement. Two attenuation values are available:

- 1:1 (0 dB), which is no attenuation;
- 2.5:1 (8 dB), which allows a signal having an amplitude 2.5 times the normal operating range to be applied to the selected input channel.

### TECHNICAL COMMENT



#### *Low Frequency Measurements —*

*The HP 5372A provides high bandwidth, high gain, and high sensitivity at its inputs. Care should be exercised when measuring noisy, low amplitude signals with slow slew rates. Because of its high input sensitivity, noisy or low frequency signals can cause the HP 5372A to count noisy events, resulting in a miscount and erroneous measurement results. Many signal sources do not provide good frequency response at low frequencies (in general, 10 MHz and below, although response varies from source to source). If the HP 5372A is miscounting a low frequency signal, it could be the result of a noisy source. Here are four ways to solve the problem:*

1. *Use a filter to filter out the noise on the input signal. Use a spectrum analyzer to see where your noise is, then choose the appropriate filter.*
2. *If the noise on the input signal is low enough, and the amplitude is high enough, then using the 2.5:1 attenuation setting may attenuate the noise enough to avoid miscounts.*
3. *Use a signal source that can provide a low frequency signal with a high signal-to-noise ratio.*
4. *Select maximum hysteresis to provide additional noise immunity.*

**Softkey Options:**

1:1 | 2.5:1

**HP-IB Command:**

ATT {X1 | X2}

**CAUTION**

---

*Be careful when connecting signals to the HP 5372A. Attenuation is a manual setting. Check the amplitude of the signal before you apply it to the instrument. Damage to the instrument is possible if you connect a signal that exceeds  $\pm 2.5$  V with attenuation set to 1:1, or  $\pm 5.5$  V with attenuation set to 2.5:1. The Preset function resets the attenuation to the 1:1 setting.*

---

**Channel C  
(Option 030)  
Attenuation Field**

When the Channel C input option is installed, a field for setting attenuation appears on the Input menu. The field can be set from 0% to 100%, in 5% steps. The attenuation range is from 0 dB to 26 dB of attenuation.

The Channel C attenuator can be used when measuring noisy signals.

**Softkey Options:**

0% | 25% | 50% | 75% | 100%

**HP-IB Command:**

CATT <number> (0 to 100)

**Comments:**

The Channel C input has the following characteristics:

Trigger Level is 0 V on a positive slope.

Input Impedance is 50 $\Omega$ , AC coupled.

**HYSTERESIS FIELD**

The Hysteresis feature can be used to increase the noise immunity of the Channel A and/or B inputs. If the HP 5372A is miscounting an input signal, it could be the result of noise on the signal. This feature allows you to select a level of hysteresis that will make the input circuitry less susceptible to counting on the noise of a signal.

Hysteresis can be set to minimum or maximum. Minimum hysteresis is the default value and represents the maximum sensitivity setting. Maximum hysteresis decreases the sensitivity so that a signal of greater amplitude is required to trigger the HP 5372A.

**Softkey Options:**

Min | Max

**HP-IB Command:**

HYST {MIN | MAX}

**Comments:**

The Hysteresis feature may be used in combination with the Attenuation feature to make measurements in low frequency applications.

It is assumed that your signal satisfies the sensitivity requirements of the HP 5372A. Refer to appendix E, "Specifications," for the sensitivity limits.



2







## Contents of Chapter

---

Chapter Overview .....	9-1
Statistics Field .....	9-2
Math Field .....	9-5
Offset Field .....	9-6
Normalize Field .....	9-6
Scale Field .....	9-7
Limits Field .....	9-8
Reference Value .....	9-9
Carrier Frequency Fields .....	9-11
Phase Result Field .....	9-11



# MATH MENU

## CHAPTER OVERVIEW

While the MATH screen is selected, the following features can be set:

- Statistics
- Math processing
- Limit testing
- Reference setting
- Carrier frequency for Phase or Time Deviation measurements
- Phase result format for Phase and Phase Deviation measurements

Figure 9-1.  
Math Menu Screen

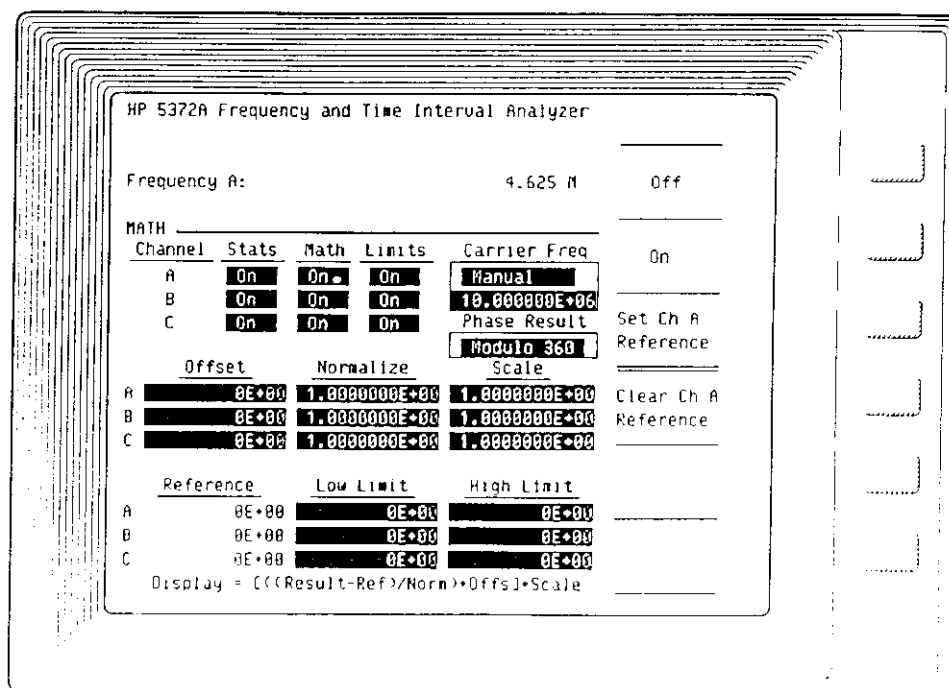

**STATISTICS FIELD**

The HP 5372A can compute statistics for all measurement functions, except Histogram measurements (described in chapter 4). The parameters computed include:

- Minimum value of acquired measurements
- Maximum value of acquired measurements
- Mean estimate of acquired measurements
- Variance of acquired measurements
- Standard Deviation of acquired measurements
- Allan Variance of acquired measurements
- Root Allan Variance of acquired measurements
- Root Mean Square of acquired measurements

These functions are enabled as a group when Statistics is set to On. When using HP-IB remote control, any of the above values can be retrieved (individually or as a group).

**Statistical Functions****MEAN** —

$$\text{Mean} = \frac{\sum_{i=1}^n X_i}{N}$$

**NOTE** 

---

*For arithmetic mean, the first measurement of the group is subtracted from each measurement for the calculation and then added back at the end of the calculation.*

---

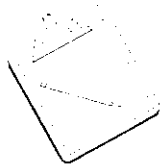

## TECHNICAL COMMENT

A different method for calculating the mean is used in the following situations:

- The measurement function is Frequency or Period
- A continuous arming mode is selected

Continuous arming is explained in chapter 5. An easy method for identifying continuous arming is to look for the terms "Block Holdoff" and "Sample Arm" on the Function menu below the **Arming Mode** field. If these terms appear, the arming mode is continuous.

- The number of measurements per block is 3 or more
- Pre-trigger is off (see Function menu)
- Inhibit is off (see Pre-trigger menu)

When the above conditions are met, the Bicentroid Mean method is used. This is an algorithm which calculates mean frequency by estimating the Least Squares Fit of a line to the events vs. time data (refer to chapter 2, "Frequency/Period Measurements," for more about time and events). The slope of this line is a constant frequency. This mean estimate more accurately represents the characteristics of the collected data as compared to the simple arithmetic mean.

## VARIANCE —

$$\text{Variance} = \frac{\sum_{i=1}^N X_i^2 - \frac{\left(\sum_{i=1}^N X_i\right)^2}{N}}{N-1}$$

## NOTE

For variance, the first measurement of the group is subtracted from each measurement for the calculation and is NOT added back at the end of the calculation.

## STANDARD DEVIATION —

$$\text{Standard Deviation} = \sqrt{\text{Variance}}$$

## ALLAN VARIANCE —

$$\text{Allan Variance} = \frac{\sum_{i=2}^N (X_i - X_{i-1})^2}{2(N-1)}$$

## ROOT ALLAN VARIANCE —

$$\text{Root Allan Variance} = \sqrt{\text{Allan Variance}}$$

**NOTE**

*The Allan Variance and Root Allan Variance are not calculated if the Inhibit feature is available and enabled.*

## RMS —

$$\text{RMS} = \sqrt{\frac{\sum_{i=1}^N X_i^2}{N}}$$

**NOTE**

*For RMS, the first measurement of the group is subtracted from each measurement for the calculation and then added back at the end of the calculation.*

For the above calculations:

- $X_i$  = an individual measurement
- $N$  = the number of measurements

- All summations except Allan Variance are for  $i = 1$  to  $N$
- For Allan Variance  $i = 2$  to  $N$

**Softkey Options:**

On | Off

**HP-IB Command:**

STAT {ON | OFF}

MIN? | MAX? | MEAN? | VAR? | SDEV? | AVAR? | RAV?  
RMS?**Comments:**

If math processing is enabled, (i.e., offset, normalize, scale), statistical calculations are performed on the measurement data after the math processing has completed.

If results are averaged (as described in chapter 7), the statistics are calculated using the measurement results before averaging.

**MATH FIELD**

The HP 5372A normally displays the result of time interval, frequency, and period measurements in units of seconds or Hertz. In some situations, it may be desirable to have calculations performed on the measured results before they are displayed. This is where the math operators are useful. They can subject the measured result to division, addition, subtraction, and multiplication before display. Industrial parameters such as flow, speed (RPM), pressure, and temperature can be expressed directly.

Math processing can be used for all measurement functions, except Histogram measurements. The math operators act on the measured results after any Reference value is subtracted, but before other post-processing operations such as statistics, limit testing, and the graphic display of the data.

Math processing is enabled or disabled separately for Channels A and B (and Channel C, Option 030 or 090). Specific math operations are also set separately for the input channels. When Math is on, the time and frequency units are blanked from the displayed results.

There are three math operators:

- Offset
- Normalize
- Scale

These functions are applied as follows:\*

$$\text{Displayed result} = \left[ \frac{\text{Result} - \text{Reference}}{\text{Normalize}} + \text{Offset} \right] \times \text{Scale}$$

### **Offset Field**

The Offset function is used to add (or subtract) a specified constant to the measurement.

Default Value = 0

Negative Range:  $-1\text{E}+12 = < n < = -1\text{E}-12$

Positive Range:  $+1\text{E}-12 = < n < = +1\text{E}+12$  and 0

Resolution =  $1\text{E}-12$

### **Normalize Field**

The Normalize function divides the measured value by a specified constant.

Default Value = 1

Negative Range:  $-1\text{E}+12 = < n < = -1\text{E}-12$

Positive Range:  $+1\text{E}-12 = < n < = +1\text{E}+12$

Resolution =  $1\text{E}-12$

---

\* Except for Phase or Phase Deviation with Modulo 360 Phase Result (see chapter 3)



**Scale Field** The Scale function multiplies a measurement by a specified scaling factor.

Default Value = 1

Negative Range:  $-1\text{E}+12 = < n < = -1\text{E}-12$

Positive Range:  $+1\text{E}-12 = < n < = +1\text{E}+12$  and 0

Resolution = 1 E-12

**HP-IB Command:**

NORM <number>

OFF <number>

SCAL <number>

**Comments:**

The advantage of having both a normalizing factor and a scale factor as part of the math processing is that a multiplying operation can come before or after the offset factor.

- Multiplication by 1.5 after the offset:

$$\text{Value} = \left[ \frac{\text{Result}}{\text{Normalize}} + \text{Offset} \right] \times \text{Scale}$$

$$\text{Value} = \left[ \frac{4.0}{1} + 5.0 \right] \times 1.5 = 13.5$$

The result is multiplied by the scale factor after the offset is added.

- Multiplication by 1.5 before the offset:

$$\text{Value} = \left[ \frac{\text{Result}}{\text{Normalize}} + \text{Offset} \right] \times \text{Scale}$$

$$\text{Value} = \left[ \frac{4.0}{.6666667} + 5.0 \right] \times 1 = 11$$

The reciprocal of 1.5 ( $\frac{1}{1.5}$ ) used as the normalization constant will effectively multiply the result by 1.5 before the offset is added.

The default values for offset, normalize, and scale (0, 1, 1 respectively) have no effect on the measurement value. Use these default values to “turn off” the functions not needed when using math processing.

## Limits Field

The Limits feature allows upper and lower limits to be set for the processed results. That is, after any math and reference processing, the measured result is compared to the entered high and low limits. When a result falls outside the limits, it will be indicated on the Numeric results screens with a “High” or “Low” label, and over HP-IB (an SRQ will be generated if at least one value is out of range).

Limit Testing works in a second mode if the lower limit is greater than the upper limit. If a result falls inside these reversed limits, it will be indicated with an “Ins” label. This is considered out of range. The result will be labeled “Pass” if it falls outside the limit values.

The following results are not limit tested: time stamps, data extended by Inhibit, and invalid data.

The Limit Status format option (Numeric screen) displays the number of measurements that were high, that passed, and that were low. This screen also shows the percentage of measurements in each of those categories. This screen will show the number of measurements that passed and the number of measurements that were "inside" when the lower limit is set to a larger number than the upper limit. The entered limits (a maximum and minimum value) are displayed on the Histogram graph as vertical lines and the Time Variation graph as horizontal lines.

Negative Range:  $-1E+34 = < n < = -1E-34$

Positive Range:  $+1E-34 = < n < = +1E+34$ , and 0.

Resolution:  $1E-34$

#### Softkey Options:

On | Off

G | M | k | m | u | n

#### HP-IB Command:

LIM {ON | OFF}

HLIM <number>

LLIM <number>

## REFERENCE VALUE

A reference value is subtracted from measurements before any math processing or display of results. Once a reference value is set, it remains in effect until it is cleared by the Clear Channel Reference softkey.

The reference value can be the statistical mean of a group of measurements or the first measured value in that group. For example, if statistics is enabled on Channel A, pressing the Set Ch A Reference softkey will enter the statistical mean of the most recently acquired Channel A measurements as the reference value.

If statistics are off, pressing Set Ch A Reference after a measurement acquisition will enter the first valid measurement result of the measurement acquisition on Channel A as the reference value. Until the reference value is cleared, it will be subtracted from every Channel A measurement result before it is displayed.

If a particular value needs to be subtracted from the measured value, use a negative value as the offset in math processing. One use for Reference is to cancel measurement offsets due to differing signal path lengths in a measurement setup.

**Softkey Options:**

Set Ch A Reference | Clear Ch A Reference  
 Set Ch B Reference | Clear Ch B Reference  
 Set Ch C Reference | Clear Ch C Reference (Option 030)

**HP-IB Command:**

SREF  
 CREF

**Comments:**

When Set Reference is selected, with Math and Statistics already enabled, the statistical mean used as the reference value is the mean of the measurement results before any math processing.

**NOTE**

---

*If you want to enable Statistics, Math, Limits, or the Reference Value for any two-channel, single-result measurement, be aware of the following:*

*The feature(s) must be enabled for the input channel that comes first alphabetically.*

*The following examples of two-channel, single-result measurements will help illustrate this concept:*

<i>Two-Channel, Single-Result Measurement Configurations</i>	<i>Enable Feature(s) on Channel</i>
<i>Time Interval B→A</i>	<i>A</i>
<i>Frequency B+C</i>	<i>B</i>
<i>Period C/A</i>	<i>A</i>
<i>Phase B rel A</i>	<i>A</i>

---

## CARRIER FREQUENCY FIELDS

For Phase and Time Deviation measurements, a carrier can be the automatically calculated mean of a block of measurements, or a manually entered carrier frequency value.



### TECHNICAL COMMENT

*When Carrier Frequency is set to Automatic, the "mean" used as the reference is the Bicentroid Mean. This is an algorithm which calculates mean frequency by estimating the Least Squares Fit of a line to the events vs. time data. The slope of this line is a constant frequency. The frequency thus calculated is used as the carrier.*

When Manual is selected, a field appears for the entry of a carrier frequency to use as a reference in generating Phase or Time Deviation results.

Manual Carrier Range: 1E-12 to 10E+9

#### Softkey Options:

Automatic | Manual

#### HP-IB Command:

CARR {AUTO | MAN}  
CFR <number> (when Carrier Frequency mode is Manual)

#### Comments:

Refer to chapter 3, "Special Purpose Measurements," for a description of the Phase Deviation and Time Deviation measurement functions.

## PHASE RESULT FIELD

The HP 5372A can display the results of Phase and Phase Deviation measurements in two different result formats. The options are:

- **Modulo 360** — All results will be in the range of -180 degrees to +180 degrees
- **Cumulative** — If the number of measurements per block is greater than 1, the phase results are referenced to the first sample of the block. The results will reflect the cumulative phase deviation of the input signal from the reference.

**Softkey Options:**

Phase Result MOD 360 | Phase Result Cumulative

**HP-IB Command:**

PHAS {MOD | CUM}

**Comments:**

Refer to chapter 3, "Special-Purpose Measurements," for a description of the Phase and Phase Deviation measurement functions.

400







## Contents of Chapter

---

Chapter Overview .....	10-1
Pre-trigger .....	10-2
Pre-trigger Control .....	10-3
Pre-trigger Amount .....	10-4
Pre-trigger Event .....	10-5
TI Detect .....	10-7
Time Interval Range .....	10-7
Inhibit .....	10-9
Inhibit and Arming .....	10-10
Inhibit and Pre-trigger .....	10-11
Inhibit and Measurement Results .....	10-11
Inhibit and Graph Data .....	10-11



## PRE-TRIGGER MENU

### CHAPTER OVERVIEW

The Pre-trigger Menu provides access to three features. They are:

- Pre-trigger Control
- TI Detect
- Measurement Inhibit

This chapter describes the three features and includes details on the use of each.

Figure 10-1.  
Pre-trigger Menu Screen

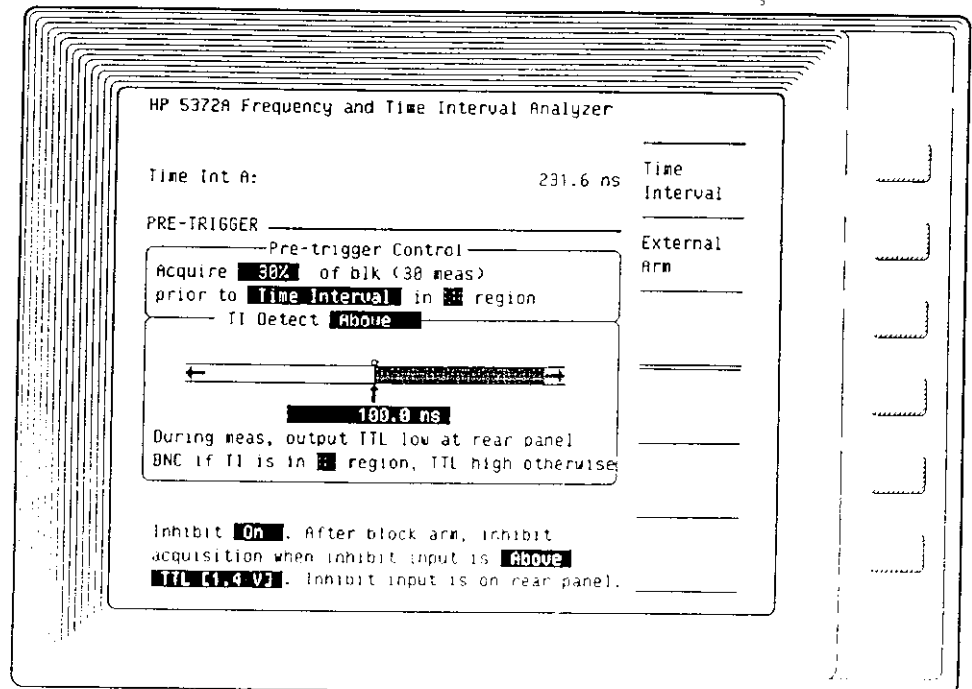

## PRE-TRIGGER

Pre-trigger provides an alternative method for ending a measurement sequence. In addition to being able to specify the end of a data acquisition by a number of measurements, Pre-trigger allows the end of a measurement sequence to be determined by events occurring in the data stream (see TI Detect), or an external input.

Using the Pre-trigger Control parameters it is possible to capture the data that occurs in a “window” positioned about the pre-trigger event. Measurements falling inside the window are acquired and displayed. Pre-trigger can operate in single and multiple block measurement sequences.

Figure 10-2 shows Pre-trigger operation for a “Single block” of measurements. Data is monitored up to the point where the pre-trigger event occurs; data is captured according to the Pre-trigger Control settings. The Block Holdoff conditions are satisfied once.

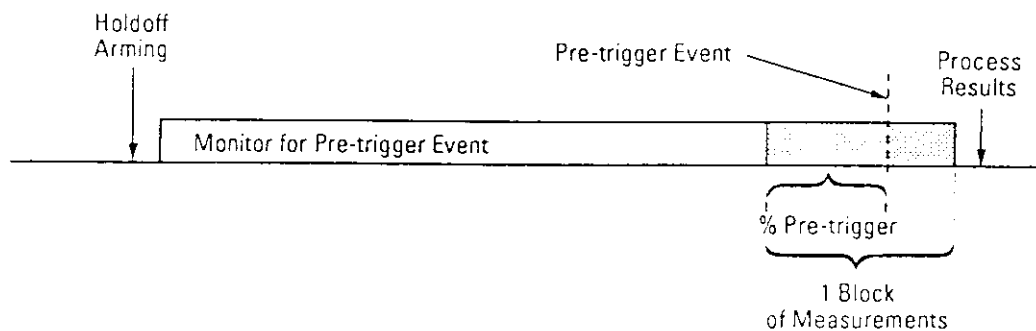

*For a single block, continuous monitoring of measurement results occurs until the Pre-trigger condition is satisfied.*

*Figure 10-2. Pre-trigger Operation on a Single Block of Measurements*

Figure 10-3 is an example of the “Multiple block” setting. Data is monitored for the pre-trigger event across block boundaries. Again, once the pre-trigger event occurs, data is captured as specified by the Pre-trigger Control settings. This can include data captured from portions of two different blocks. The Block Holdoff conditions must be satisfied prior to each block of measurements being monitored. If the pre-trigger event occurs between blocks, it will not be detected. The pre-trigger event is specified on the Pre-trigger menu. Pre-trigger is enabled on the Function menu.

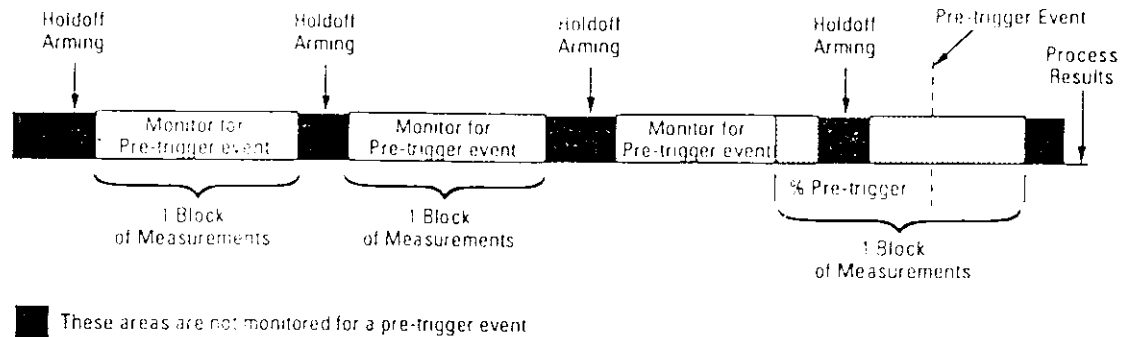

*Blocks of measurements are monitored until Pre-trigger event occurs.*

Figure 10-3. Pre-trigger Operation on Multiple Blocks of Measurements

### NOTE

*Pre-trigger is unavailable for the following measurement functions:*

- Rise Time
- Fall Time
- Positive Pulse Width
- Negative Pulse Width
- Duty Cycle
- Phase
- Phase Deviation
- Time Deviation
- Peak Amplitude

*Pre-trigger is unavailable for non-continuous arming modes. Refer to chapter 5, "Arming," for a description of these modes.*

## PRE-TRIGGER CONTROL

The conditions for Pre-trigger are set under Pre-trigger Control. The HP 5372A can pre-trigger on a signal applied to the External Arm input or a measured time interval when using the TI Detect feature. Pre-trigger lets you capture a portion of the block of measurements prior to a pre-trigger event. The amount of data acquired before pre-trigger can be specified as a number of measurements, or a percentage of the number of measurements in a block. See Figure 10-4 for an example of Pre-trigger Control set to capture 50% of the block that occurs before a positive edge at the External Arm input.

Figure 10-4.  
Pre-trigger on  
External Arm

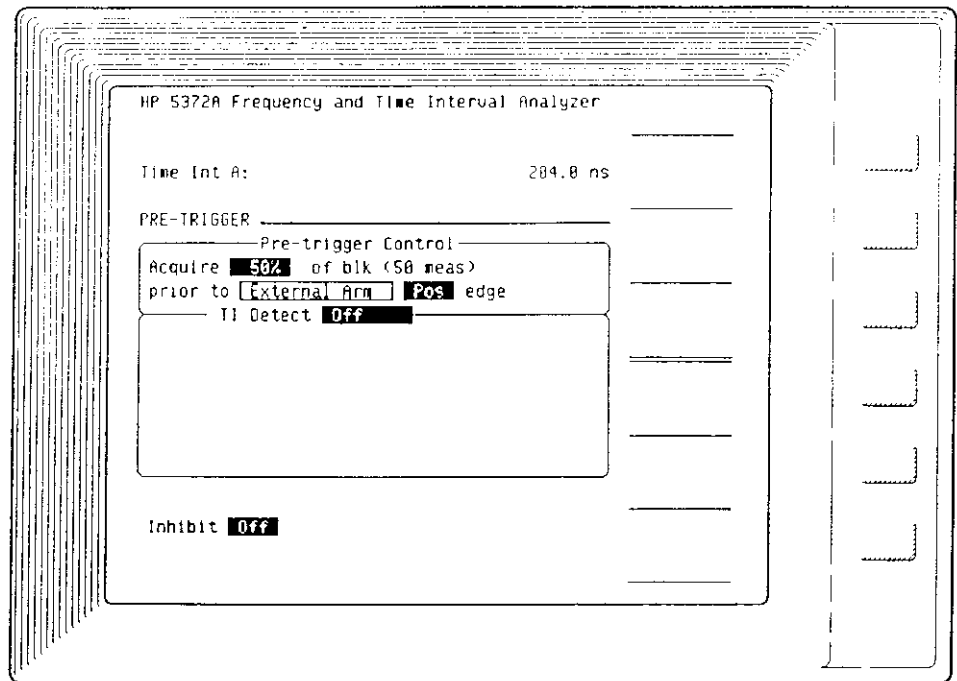

### Pre-trigger Amount

The pre-trigger amount is the portion of the block of measurements specified on the Function menu that will be acquired prior to the pre-trigger event. The portion of the block can be specified as a percentage, 0% to 100%, or a number of measurements, 1 to the number of measurements in the block. Once a numeric entry is initiated for the pre-trigger amount, two softkey choices will appear. Use the % softkey to enter a percentage of the block; use the **Samples** softkey to enter a number of measurements. The **Enter** key defaults to the last mode used, either percentage or number of measurements.

### NOTE

*For Histogram measurements, the pre-trigger amount is not selectable; it is restricted to 100%. This means that all measurement data up to the pre-trigger event is captured. The pre-trigger event ends the measurement acquisition.*

### Softkey Options:

% | Samples

---

**TECHNICAL COMMENT**

---

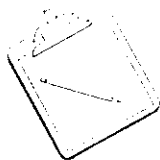

*Pre-trigger Amount Accuracy* — The Pre-trigger system has been designed for accurate, on-the-fly detection of characteristics in the data stream. When a pre-trigger event is detected, acquisition terminates with the data surrounding the pre-trigger event available for analysis.

The collected data can be said to have occurred inside the “capture window”. The width of the capture window, and its placement about the exact location of the pre-trigger event, are extremely sensitive to the input data, and to user-selected characteristics of the sampling. Consequently, it is inappropriate to expect exact numbers of measurements to precede, or follow, the pre-trigger event. (You should expect a variation of up to 6 measurements.) Similarly, it is inappropriate to expect an exact number of measurements to fall within the capture window. (You should expect the number of measurements to range from 0 to the measurement size +1, depending on the input data. Regardless of variations in the size or position of the capture window, the pre-trigger point is correctly located within the collected data.

---

## Pre-trigger Event

The event upon which the HP 5372A will pre-trigger can be a signal applied to the External Arm input, or when making a time interval measurement, a measured time interval.

The pre-trigger event is specified as follows:

- A positive or negative slope of a signal at the External Arm input. The voltage value is set on the Input menu.
- A measured time interval value according to the settings of the TI Detect feature. It is possible to have the HP 5372A pre-trigger on the following conditions using the TI Detect feature:
  - A measured time interval greater than a specified value. Press the **Detect Region Above** softkey and enter the time interval value that if exceeded should cause pre-trigger. (Excludes set value)
  - A measured time interval less than a specified value. Press the **Detect Region Below** softkey and enter the time interval value below which the HP 5372A should pre-trigger. (Excludes set value)

- A measured time interval between two specified values. Press the **Detect Region Inside** softkey and enter the value of the minimum time interval that should pre-trigger the Analyzer and the value of the maximum time interval that should cause pre-trigger. (Includes set values)
- A measured time interval outside of a range specified by two values. Press the **Detect Region Outside** softkey and enter the time interval value below which the Analyzer should pre-trigger and the time interval value that if exceeded should cause pre-trigger. (Excludes set values)

**Softkey Options:**

External Arm | Time Interval

Pos | Neg



**TI DETECT**

The TI Detect feature can be used to output a signal at the rear panel when a measured time interval satisfies a specified condition. The time interval can also be used as a pre-trigger event for a time interval measurement. *Figure 10-5* shows an example of TI Detect set to output a TTL low signal when the measured time intervals are equal to, or above 99.0 ns and equal to, or below 101.0 ns.

*Figure 10-5.*  
*TI Detect Between*  
*Two Values*

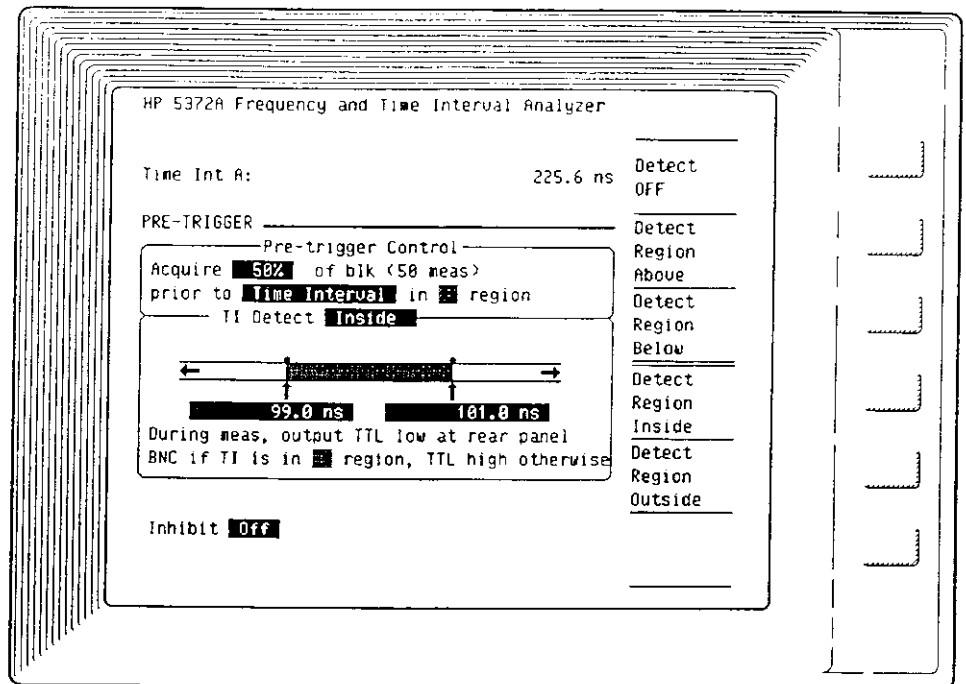
**Time Interval Range**

TI Detect allows you to set thresholds for time interval measurements so that when a measurement satisfies a specified condition:

- A pre-trigger event occurs for a time interval measurement sequence using Pre-trigger.
- A TTL low signal is supplied to the rear-panel TI Detect output.

To have TI Detect provide a pre-trigger event for a measurement sequence, Pre-trigger must be enabled on the Function menu and Pre-trigger Control must be set to **Time Interval** on the Pre-trigger menu.

The rear-panel output goes low at the first occurrence of a measured time interval that satisfies the conditions set for TI Detect. The signal stays low as long as measurements continue to satisfy the conditions, going high when a measurement value does not meet the conditions or whenever a new measurement sequence starts.

**NOTE**

---

*TI Detect is only available for the following measurements:*

- *Time Interval*
- *Continuous Time Interval*
- *± Time Interval*
- *Histogram Time Interval*
- *Histogram Continuous Time Interval*
- *Histogram ± Time Interval*

*There is less than a 600 ns delay between the time a measurement value satisfies the TI Detect conditions and the time the signal level at the rear panel will change state. For this reason, the output may not be suitable for exact timing. This delay also applies when using TI Detect as the pre-trigger event. Up to 600 ns may elapse between a measured value that satisfies the TI Detect conditions and when the measurement hardware receives a pre-trigger signal.*

---



### TECHNICAL COMMENT

The TI Detect feature outputs a low signal at the rear panel when a measured time interval satisfies the set thresholds. The following list summarizes the TI Detect settings and what can be expected at the rear-panel output. Signal output levels are TTL (0 to 5 V) into  $\geq 10\text{ k}\Omega$  or 0 to 1 V (minimum) into  $50\ \Omega$ .

- *TI Detect Region Above* — Output is low when measured time interval is above the entered value, high when below.
- *TI Detect Region Below* — Output is low when measured time interval is below the entered value, high when above.
- *TI Detect Region Inside* — Output is low when measured time interval is equal to, or between the entered values, high when above or below.
- *TI Detect Region Outside* — Output is low when measured time interval is outside of the entered values, high when equal to, or between.

*TI Detect can only be enabled when time interval measurements are being made.*

---

#### Softkey Options:

Detect OFF | Detect Region Above | Detect Region Below

Detect Region Inside | Detect Region Outside

### INHIBIT

The Inhibit feature makes it possible to selectively suppress data collection by the HP 5372A. An external signal is required at the Inhibit input on the rear panel. One of three voltage thresholds can be specified and the enabling condition can be set as above or below any of the three thresholds.

In general, when a measurement sequence is inhibited, the acquisition of measurement data is suspended. When no longer inhibited, the measurement sequence resumes and progresses to a normal termination once the specified number of measurements have been collected. *Figure 10-6* shows an example of a measurement inhibited by a signal that exceeds 1.4 V at the rear-panel Inhibit input.

Figure 10-6.  
Measurement Inhibited  
By Rear-Panel Signal

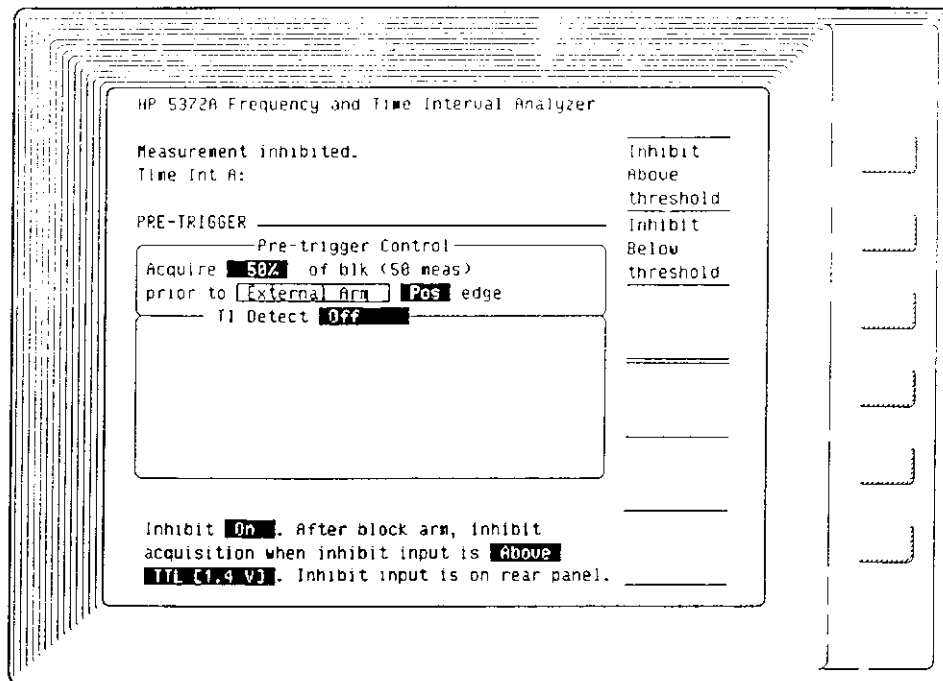

#### Softkey Options:

Off | On

Inhibit Above threshold | Inhibit Below threshold

Inhibit Level GND [ 0.0 V]

Inhibit Level TTL [ 1.4 V]

Inhibit Level ECL [-1.3 V]

### Inhibit and Arming

Inhibit does not interfere with arming. Blocks and measurement samples within blocks are armed normally when Inhibit is asserted. No new measurements are collected until Inhibit is de-asserted.

#### NOTE

*Inhibit is not available for the non-continuous arming modes. Refer to chapter 5, "Arming," for a description of these modes.*

## Inhibit and Pre-trigger

Inhibit does not stop detection of a pre-trigger event on the External Arm input. However, if the pre-trigger event is to be followed by measurements, no measurements will be made until Inhibit is de-asserted.

Inhibit will prevent detection of a time interval pre-trigger event. While Inhibit is asserted, the HP 5372A does not monitor the data for the pre-trigger criteria. Pre-trigger will operate normally once Inhibit is de-asserted.

## Inhibit and Measurement Results

If a measurement is in progress when Inhibit is asserted, the action taken is determined by the type of measurement being made. During Time Interval, Histogram Time Interval,  $\pm$  Time Interval, Histogram  $\pm$  Time Interval, or Externally Gated measurements, the HP 5372A will discard the measurement in progress and wait until Inhibit is de-asserted to begin another measurement. If the measurement is Continuous Time Interval, Histogram Continuous Time Interval, Frequency, Period, or Totalize, the measurement will be extended, ending on the first input event after Inhibit is de-asserted. The measurements that are extended due to Inhibit are included in the list of results on the Numeric screen, but not in statistics or Histogram graph results.

## Inhibit and Graph Data

On the Time Variation graph:

- When measurements are extended due to an Inhibit, an "I" will appear on the graph, but no data point will be plotted. An example with a frequency measurement is shown in *Figure 10-7*.
- When an Inhibit occurs between measurements, an "I" will appear on the graph with a measurement data point. This indicates that an Inhibit occurred between this measurement and the one preceding it. An example with a time interval measurement is shown in *Figure 10-8*. The display is similar for the Event Timing graph.

Figure 10-7.  
Frequency Measurement  
With Inhibit

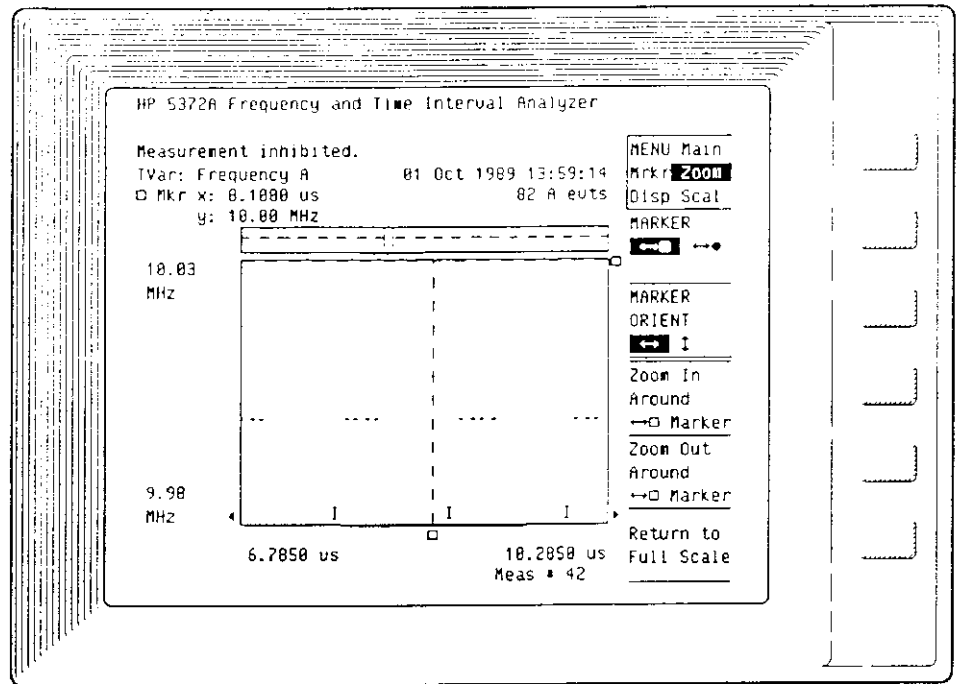
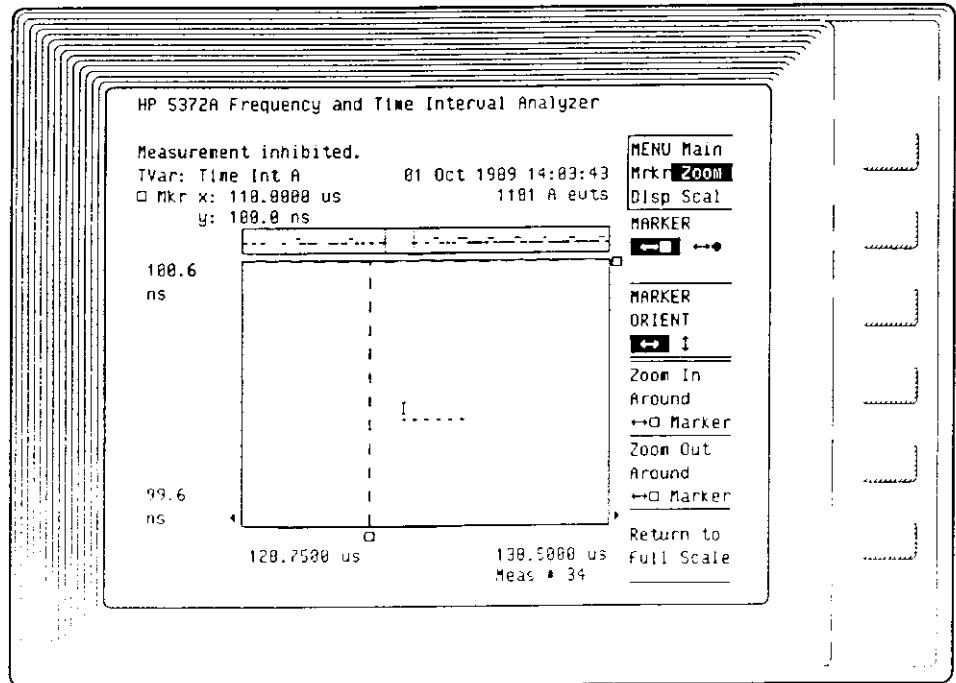

Figure 10-8.  
Time Interval  
Measurement  
With Inhibit



## Contents of Chapter

---

Chapter Overview .....	11-1
Instrument State Menu .....	11-2
Save/Recall a Setup .....	11-2
Reg # .....	11-2
Write Protect .....	11-2
Description .....	11-2
Date/Time Saved .....	11-2
Erase Register Data .....	11-2
Saved Instrument Parameters .....	11-3





## INSTRUMENT STATE MENU

### CHAPTER OVERVIEW

While the Instrument State menu is selected, the following features are available:

- Write protection for nine of the ten front panel storage registers can be switched on or off. (Register "0" is used to store the front panel setup when Preset or Default Meas Setup is selected. There is only a recall capability for Register "0".)
- Function and arming description for each of the stored front panel measurement setups.
- The date and time that each front panel setup was saved.

Figure 11-1.  
Instrument State  
Menu Screen.

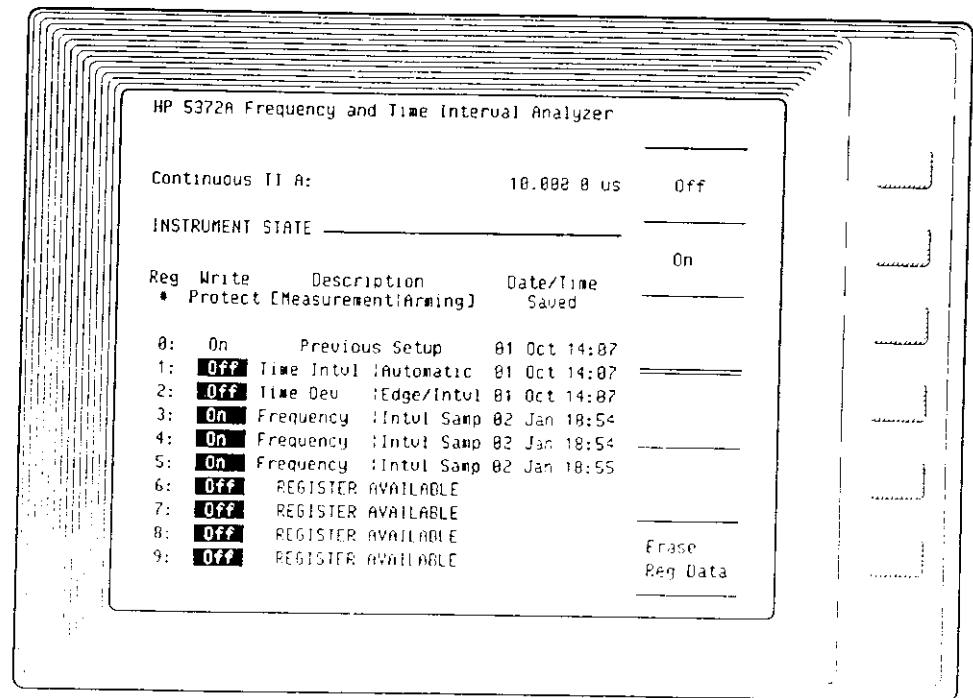

**INSTRUMENT  
STATE MENU**

The Instrument State menu is a listing of all currently stored instrument setups. The stored setups can be protected from overwriting with the softkey choices. This is the only element that can be modified on the screen.

Up to ten front panel setups can be stored in registers "0" through "9". The Save key can only be used to store front panel setups in registers "1" through "9". Register "0" is reserved to automatically store the current front panel setup when the Preset or Default Meas Setup function is selected.

**Save/Recall a Setup**

A setup is stored in registers "1" through "9" by pressing the Save key on the front panel followed by the number of the register where the setup is to go. The recall feature works the same way. Press the Recall key followed by the number of the register ("0" to "9") where the setup is stored. This can be performed while using any menu.

**Reg #**

The storage registers are numbered "0" to "9".

**Write Protect**

When set to "On" for a register, the contents of that register cannot be overwritten or erased. Register zero is always write-protected because it is used to store the setup prior to a Preset or Default Measurement Setup condition.

**Description**

The description of the contents of each register consists of the function and the arming mode of the stored instrument setup.

**Date/Time Saved**

The date and time a front panel setup was saved. (Note: Go to the System menu to set the correct date and time.)

**Erase Register Data**

Pressing this softkey will erase the data of the register highlighted by the menu cursor. The register becomes available. This function has no effect on write-protected registers. Register "0" is not erasable.

SAVED  
INSTRUMENT  
PARAMETERS

The following instrument parameters are stored for later recall when the Save key is used to store an instrument setup:

- Single or Repetitive acquisition mode
- All Function Menu settings
- All Input Menu settings
- All Math Menu settings
- All Pre-trigger Menu settings
- System Menu settings except for Talk/Listen or Talk Only mode selection, HP-IB address, or print source selection
- All Numeric screen settings
- The following Graphic screen settings:
  - Graph Type (Histogram, Time Variation, Event Timing, or Window Margin)
  - X- and Y-axis Manual Scaling status
  - All Manual Scaling values
  - Active marker ("square" or "circle" and orientation)
  - Marker display mode
  - Marker Next mode
  - Grid status
  - Outline mode
  - Yscale mode
  - Update mode
  - Connect data mode
  - View Channel mode for Histogram and Time Variation
  - Window Margin Analysis parameters



## Contents of Chapter

---

Chapter Overview .....	12-1
HP-IB Configuration .....	12-2
Addressing Mode Field .....	12-2
Device Address/Print Field .....	12-2
Result Format Field .....	12-3
Response Timeout Field .....	12-4
Options Summary .....	12-5
Measurement Mode Field .....	12-5
System Clock Field .....	12-5
Firmware Revision .....	12-6
Display Blank Softkey .....	12-6



## SYSTEM MENU

CHAPTER  
OVERVIEW

While the SYSTEM screen is selected, the following features can be set:

- HP-IB configuration for computer control of the HP 5372A
- HP-IB configuration for screen prints and plots without the need for an HP-IB controller
- Timeout limit
- FastPort (Option 020)
- Measurement Mode
- System clock
- Display blank

Figure 12-1.  
System Menu Screen

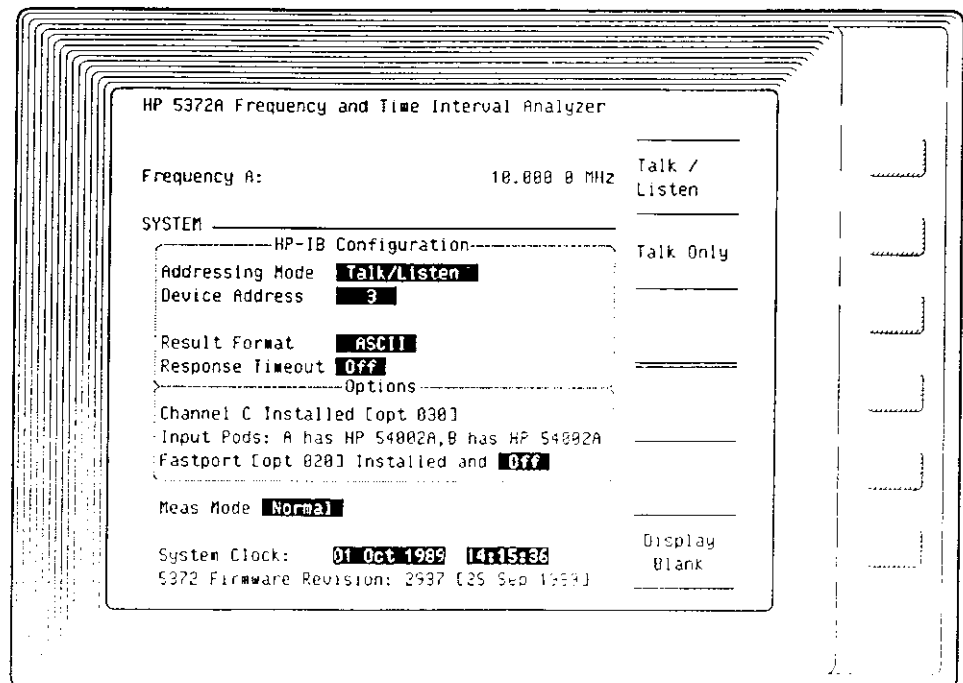

## HP-IB CONFIGURATION

The HP-IB Configuration consists of setting the conditions that allow external control of the HP 5372A, or the copying of instrument display screens to a printer or plotter. Only Graphic screens can be plotted. The printer or plotter should be set to Listen Only.

### Addressing Mode Field

The Talk/Listen mode sets the HP 5372A to respond to interface messages and programming commands. Interface messages consist of routine communications between the instrument and controller necessary for bus management.

The Talk Only mode allows the HP 5372A to only send data. This is useful to allow data to be sent to a plotter or printer without the need for an HP-IB controller. The communication path is one-way versus two-way for the Talk/Listen mode.

#### Softkey Options:

Talk / Listen | Talk Only

#### NOTE

---

*Do not use the Print key while the HP 5372A is set to Talk Only and connected to an HP-IB controller. The HP 5372A will lock up (there is no response to any key press). The power switch needs to be set to STBY and then back to ON to continue operation.*

---

### Device Address/Print Field

A Device Address field appears when Talk/Listen mode is selected. The device address is the code used by the HP-IB controller to identify the HP 5372A. The range of permissible addresses is "0" to "30", inclusive. The address is saved in battery backed-up RAM when the instrument is switched off or unplugged. If the address cannot be recalled due to memory or battery failure, the device address defaults to "3".

When Talk Only addressing mode is selected, a Print field takes the place of the Device Address field on the menu screen. The options here are:

- Display
- Meas Result



Display sets the contents of the display screen as the source of information to be sent to the printer/plotter when the Print or Plot Graph function is enabled. Meas Result has the HP 5372A send measurement results to the attached printer whenever measurements are acquired, or when the Print function is enabled. The type of measurement result information that is sent to the printer is determined by the Numeric display screen selection at the time of the measurement. For example, if you want strictly measurement results, select the Result display format on the Numeric screen. All screens can be printed, but only Graphic screens can be plotted.

#### Softkey Options:

For Device Address field: Increment Value | Decrement Value

For Print Source field: Display | Meas Result

#### HP-IB Command:

Device address cannot be set over HP-IB.

For Print Source field: PSO {DISP | MEAS}

### Result Format Field

There are three result formats for the output of measurement data from the HP 5372A. The formats are summarized here. For a full explanation of these output formats and how to use them, see the Programming Manual.

- ASCII

The ASCII measurement format sends processed measurement data. This is the most complete and general format, but the slowest.

- Floating Point

This format matches the numerical format of the HP 9000 Series 200/300 computers. It is faster than ASCII because no translation or reformatting is required between the HP 5372A and computer when the HP BASIC "Transfer" statement is used.

- Binary

The Binary measurement format sends unprocessed measurement data to an HP-IB controller. This is the fastest output mode of the three. The data is made up of binary data from the counting hardware. Therefore, intermediate computations are required to convert binary data to floating point results.

**NOTE**

---

*With Result Format set to "Binary," the HP 5372A does no processing of the measurement data being collected. As a result, no measurement results are available from the Analyzer, whether it is in Remote or Local.*

---

**Softkey Options:**

ASCII | Floating Point | Binary

**HP-IB Command:**

OUTPUT {ASC | FPO | BIN}

**Response  
Timeout Field**

The Response Timeout field is used to set a time limit on how long the HP 5372A will wait to detect an input signal before "timing out." For front panel operation, timing out means that when the timeout value elapses before an input signal is detected, the message, "Waiting for signal...," appears at the top of the display for approximately three seconds. In remote operation, a bit in one of the status registers is set when a timeout occurs. The bit can be used to issue a message to the controller indicating that no measurement is taking place.

**Softkey Options:**

Numeric entry. Range = 0 to 36000 seconds, the default value is 5 seconds.

**HP-IB Command:**

MTST {ON | OFF}

MTV <number>

**OPTIONS  
SUMMARY**

A short summary is given of the status of the options installed in the HP 5372A. The On/Off selection for FastPort (Option 020) is included here as well.

**MEASUREMENT  
MODE FIELD**

The selection of the Fast or Normal measurement mode specifies one of two different data sizes for the time and event samples acquired by the HP 5372A. Normal mode uses the full 32 bits of counting register data to provide the maximum measurement range of time and frequency. In contrast, Fast mode uses only 16 bits of register data to allow a faster sample rate, but a decreased range of time and frequency measurements.

Fast mode limits the minimum frequency that can be measured to 8 kHz and limits the maximum time measurement to 131  $\mu$ s. In Normal mode, the minimum frequency is 0.125 Hz and the maximum time measurement is 8.0s. The measurement limits for Normal and Fast modes are described throughout chapters 1, 2, and 3.

**Softkey Options:**

Fast | Normal

**Comments:**

Unless a faster sampling rate is critical to your measurement, use Normal mode.

**SYSTEM CLOCK  
FIELD**

The system clock provides a real-time record for measurement screens and printer/plotter output.

**Softkey Options:**

Increment | Decrement

**HP-IB Command:**

TOD <hr><min><sec>

DAT<year><month><day>

**Comments:**

To Set the System Clock:

There are two clock fields, one for the date and one for the time. The date field displays the day, month, and year. The time field displays the hour, minute, and second. Each of these six indications is separately set. The hour display uses the 24-hour convention. The system clock setting is saved in battery backed-up RAM.

1. Move the menu cursor to the date or time field using the cursor keys.
2. Move the menu cursor to highlight the day or time indicator to be changed using the cursor keys.
3. Press the Increment or Decrement softkeys to set the desired entry.
4. Repeat steps 1, 2, and 3 until system clock is correctly set.

**FIRMWARE REVISION**

The display screen shows the firmware revision resident in your HP 5372A. This date code is important for reference purposes should firmware upgrade or service be necessary.

**Softkey Options:**

None.

**HP-IB Command:**

\*IDN? (returns instrument I.D., i.e., HP 5372A, and the date code of the installed firmware revision)

**DISPLAY BLANK SOFTKEY**

The Display Blank softkey is used to disable the front panel and blank the display. Press Display Blank softkey, then press Lock Panel/Blank Dsp softkey. This key sequence enables the Display Blank Mode.

When in this mode, the display is blanked, except for the instructions for exiting Display Blank. Status messages will be displayed. All measurement data can be retrieved over HP-IB. The front panel keyboard is locked-out, except for the DATA ENTRY keypad and the Restart key. This mode is retained when the instrument is switched off, and can be exited only by entering a numeric value of "1000" or greater with the DATA ENTRY keypad.

324

CHRYSLER CITY



## Contents of Chapter

---

Chapter Overview .....	13-1
Diagnostic Tests .....	13-2
Test Screen .....	13-3
To Run a Test .....	13-3
Power-up Tests .....	13-4
User Tests .....	13-4
Self Test .....	13-5
Time Base Test .....	13-5
Input Pods Test .....	13-5
Front Panel Test .....	13-5





## TEST MENU

CHAPTER  
OVERVIEW

While the Test menu is displayed, the following features are available:

- Instrument self-test
- Hardware diagnostic tests
- Memory diagnostic tests
- CRT diagnostic tests and adjustments
- Calibration routines

Figure 13-1.  
Test Menu Screen

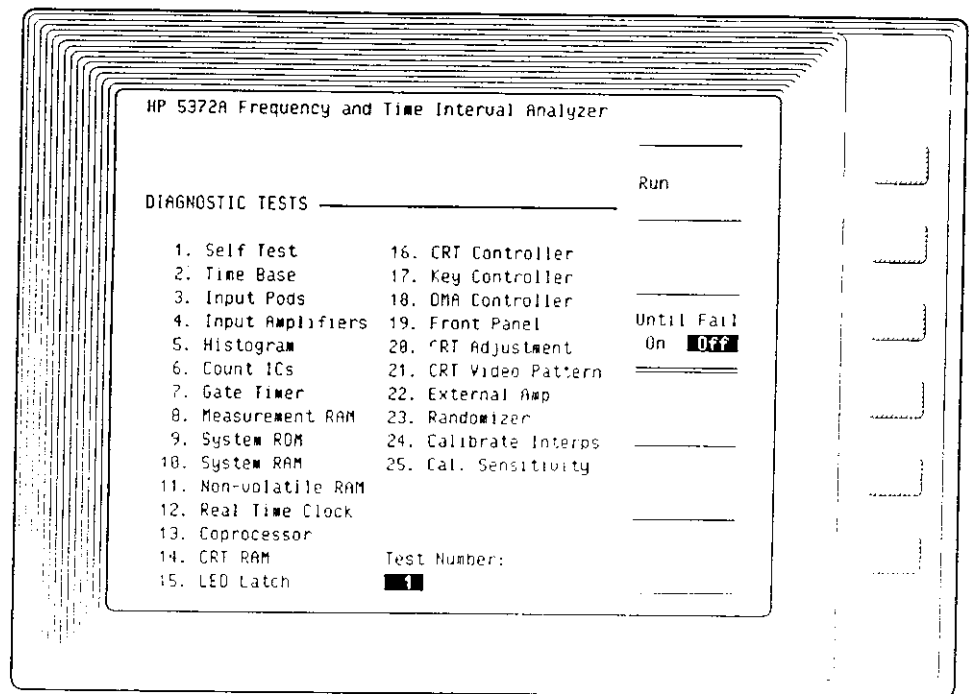

## DIAGNOSTIC TESTS

The HP 5372A comes with a full complement of tests to check its operation and help troubleshoot suspected failures.

All of the test routines are intended to aid in repair and operation verification by qualified service personnel. Some tests, however, can be used to verify a limited number of instrument operations. These tests are summarized under *User Tests*. There is no detailed information presented here on how to interpret test results. Consult the HP 5372A Service Manual for complete information on these diagnostic tests.

### Softkey Options:

Run | Pause | Until Fail | Stop

### HP-IB Commands:

TEST <number> (1 to 25) — To run a test

PAUS — To pause a test

CONT — To resume a test

UFA {ON | OFF} — To run a test until a failure is detected

### Comments:

Run starts the selected test, or resumes a test that has been paused.

Pause suspends a currently running test until the Run softkey is pressed.

Until Fail "On" causes a test to be cycled continuously until a failure is detected.

Stop halts a test and displays the main Diagnostic Test menu.

Figure 13-2.  
Diagnostic Test  
Screen

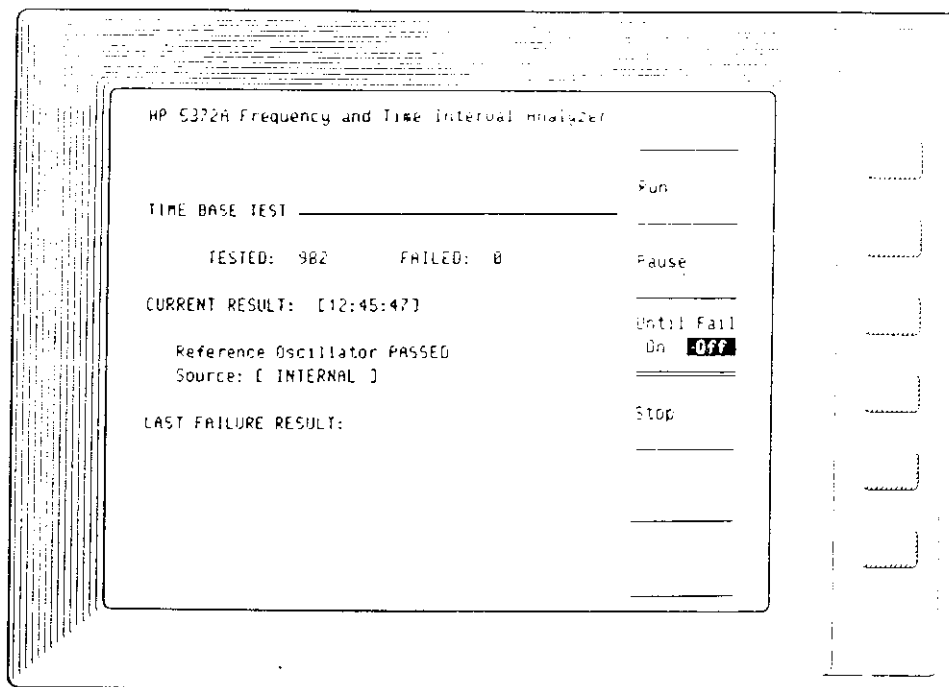

### Test Screen

Once a test is started, the screen for the selected test will be displayed. The screen displays the title of the test currently running, the number of times the test has executed and the number of failures. The time of the current result, and the last failure result are also displayed, along with the detected failed component, if available.

### To Run a Test

1. When the Test menu is called up, you will notice that one of the tests is highlighted. This test will execute if the Run softkey is pressed.
2. If you want to run a different test, highlight that test using the Cursor/Scroll keys, or enter the test number in the **Test Number** field using the numeric keys. Press the Enter key to complete a numeric entry.
3. Press the Run softkey to start the test. The test will execute continually until the Stop softkey is pressed, or until another menu key is selected via the keyboard or HP-IB.
4. The test can be temporarily halted by pressing the Pause softkey. This will suspend the test and freeze messages on the CRT display.

5. Press the Run softkey to resume the test.
6. The tests can also be executed in “Until Fail” mode. This mode causes tests to run continually until a failure occurs. At that time the test goes into the “pause” mode. Press the Until Fail softkey to turn on this function.

## POWER-UP TESTS

A comprehensive series of tests are run at power-up. If any failures are detected, descriptive messages will be displayed on the CRT screen. The following tests are executed during power-up:

- Time Base
- Input Pods
- Input Amplifiers
- Histogram Hardware
- Count ICs
- Gate Timer
- Measurement RAM
- System ROM
- System RAM
- Non-volatile RAM
- Real-time Clock
- Co-processor
- CRT RAM
- LED Latch
- CRT Controller
- Key Controller
- DMA Controller

If any of these tests fail, have the instrument serviced.

## USER TESTS

For the most part, the diagnostic tests are intended for the qualified service technician. There are some tests, however, that can help a user discover basic information about the current status of the instrument.

For example, is the reference oscillator locked? Are the input pods properly installed? Are all the front panel keys being detected by the internal processor? Use the following tests to check basic operation of the HP 5372A.

**Self Test** Test #1: A group of fifteen diagnostic tests can be run. There will be a pass/fail indication displayed for each test. A message will be displayed for the last detected failure. This is a good test to run if you just want to quickly check overall instrument operation.

**Time Base Test** Test #2: This test verifies that the 500 MHz reference oscillator is in a "locked" condition indicating that it is operating correctly. The frequency source for the reference oscillator is also specified. It can be either the internal source or an external frequency standard.

**Input Pods Test** Test #3: This test verifies that the input pods are installed correctly and displays the model number of each pod.

**Front Panel Test** Test #19: This test is used to verify the operation of each of the front panel keys and the knob. Follow the directions displayed on the test screen.



000000

THE FINEST MINDS





## Contents of Chapter

---

Chapter Overview ..... 14-1  
Help Menu ..... 14-2

1

2

### CHAPTER OVERVIEW

While the HELP screen is selected, the following features are available:

- User information organized by front panel feature
- Softkey selection of help information
- HP-IB output formats
- Arming mode summary
- Input signal specification summary

Figure 14-1.  
Help Menu Screen

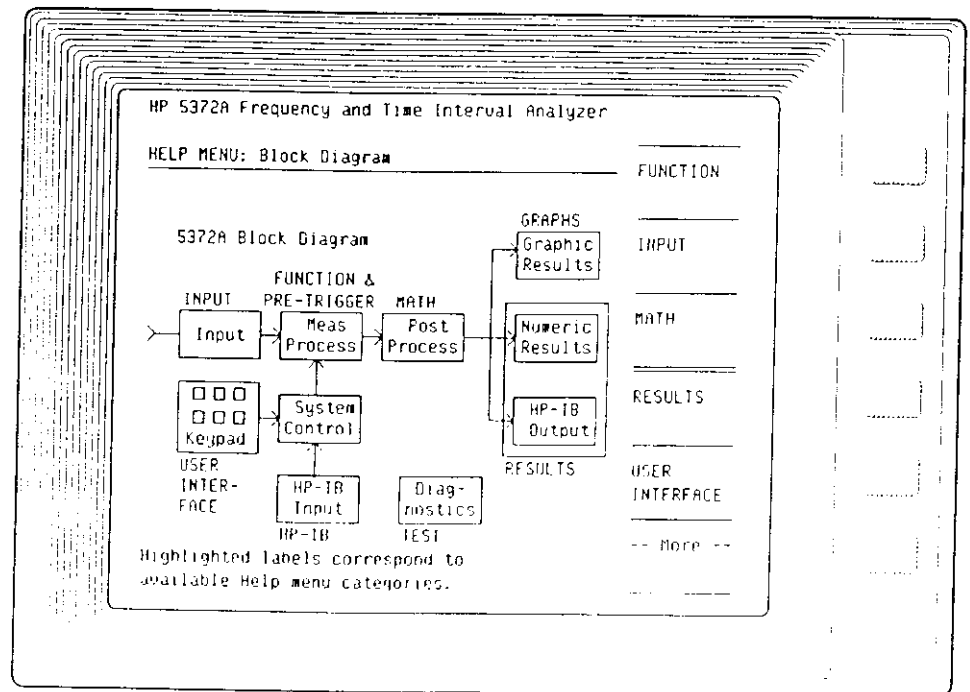

## HELP MENU Description:

The HELP menu screen is softkey-driven and provides brief user information. Refer to the text below for references to the Operating and Programming manuals.

The HELP screen information is grouped as follows:

### FUNCTION

- Arming Overview
- Valid Arm Options
- Meas Size/Block Size
- Pre-trigger/TI Detect
- Inhibit

For more information: Chapter 5, 10

### INPUT

- Input Channels
- Input Trigger
- Input Characterization
- Input Separate/Common
- Optional Channel C

For more information: Chapter 8

### MATH

- Math Modifiers/Statistics
- Limits/Reference

For more information: Chapter 9

### RESULTS

- Numeric Screens

For more information: Chapter 15

- ASCII Output
- Floating Point Output
- Binary Output

For more information: Programming Manual

## USER INTERFACE

- User Interface

For more information: Getting Started Guide

- Numeric Entry
- Other Keys

For more information: Chapter 6

- Errors

For more information: Appendix C

- Instrument State

For more information: Chapter 11

## GRAPHS

- Graphics Overview
- Marker Features
- Zoom Features
- Scaling Features

For more information: Chapter 16

## HP-IB

- Command Structure
- Status Byte
- Event Status Register
- Hardware Status Register

For more information: Programming Manual

## TEST

- Test

For more information: Chapter 13



)

)





## Contents of Chapter

---

Chapter Overview .....	15-1
Main/Formats Softkey .....	15-1
Numeric Format Displays .....	15-1
Result Display .....	15-2
Set Param/Meas # softkey .....	15-2
Expanded Data softkey .....	15-3
Prior Page/Next Page softkeys .....	15-3
Measurement Scrolling .....	15-3
Measurement Result Identifiers .....	15-3
Statistics Display .....	15-4
Numeric Parameter field .....	15-5
Result/Statistics Display .....	15-5
Limit Status Display .....	15-6
Bold Display .....	15-7
Set Param/Meas # Softkey .....	15-7



## NUMERIC RESULTS

---

### CHAPTER OVERVIEW

While the Numeric screen is selected, the following formats for the measurement results are available:

- List of measurements
- Measurement statistics
- Pass/Fail data based upon user-set limits
- Expanded Data showing measurement interval or untimed events
- Enlarged numeric display of measurement results

### MAIN/FORMATS SOFTKEY

This softkey is used to select the "Main" menu, or the Format options" menu. The Format options menu is used to select between the five different numeric format displays. The Main menu options are described for each display in this chapter.

### NUMERIC FORMAT DISPLAYS

The five Numeric format displays are:

- Result Display
- Statistics Display
- Result/Statistics Display
- Limit Status Display
- Bold Display

There is status information near the top of the Numeric screens to indicate the following conditions:

- Measurement function and channel(s)
- Date and time that each block of measurements is acquired
- Number of measurements
- Number of blocks for a multiple block acquisition that exceeds measurement memory
- Math On status

Additionally, there is a parameter field at the top of the Numeric screen. The parameter displayed depends on the numeric field last selected with the menu cursor prior to pressing the Numeric key. The numeric value can be modified here using the DATA ENTRY keypad or the ENTRY/MARKER knob. Only numeric fields are displayed, and it is the last selected numeric field from the Function, Input, Math, or Pre-trigger menu screen.

## RESULT DISPLAY

Figure 15-1.  
Result Display

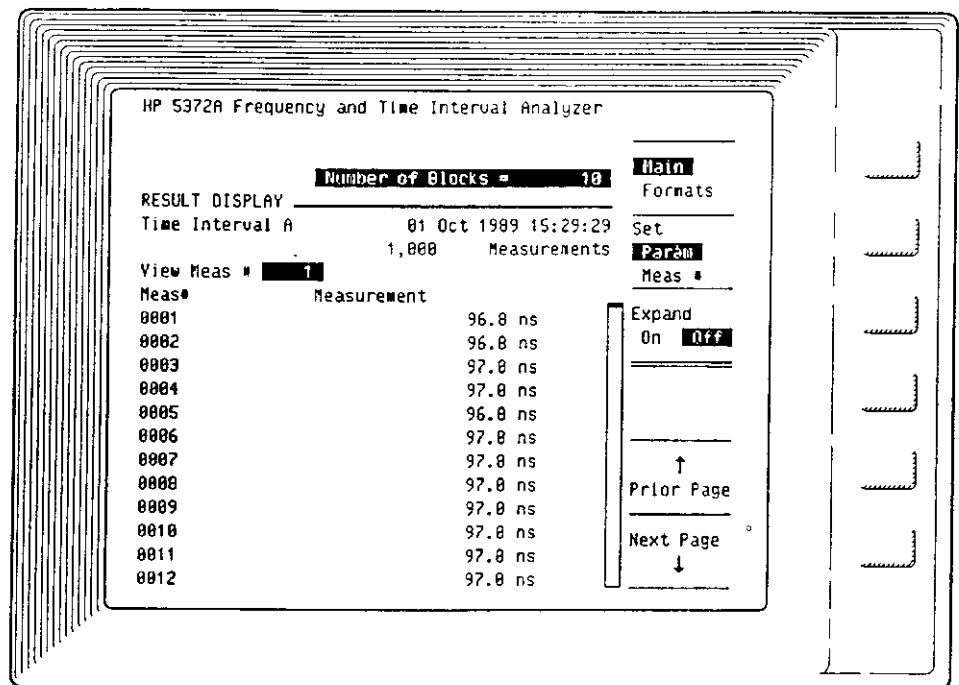

The Result Display lists up to twelve measurement results.

### Set Param/Meas # softkey

This softkey selects either the measurement number field or the numeric parameter field at the top of the display.

When "Meas #" is selected, enter the number of any measurement in the acquisition using the DATA ENTRY keypad, or the ENTRY/MARKER knob, and that measurement result will be displayed.

When "Param" is selected, the parameter field can be modified using the DATA ENTRY keypad or the ENTRY/MARKER

knob. Only entries within the range of the selected parameter will be allowed.

### **Expanded Data softkey**

This softkey sets Expanded Data On or Off. When set to "On":

- For frequency, period, or totalize measurements, the time over which the measurement was acquired is displayed. Since the HP 5372A uses a reciprocal counting technique which synchronizes measurements to the input signal, actual measurement gates may vary by up to one period of the input signal from set intervals. (See chapter 2.)
- For time interval measurements, the number of missed events is shown. A missed event for a Time Interval measurement is an event that occurred between measurements. For Continuous Time Interval measurements, a missed event is an event that was included in the measurement but the time of occurrence of the event is not known. (See chapter 1.)

### **Prior Page/Next Page softkeys**

Use these softkeys to view the results of the measurements acquired before (Prior Page) or after (Next Page) the currently displayed results in the acquisition.

### **Measurement Scrolling**

The "up" and "down" CURSOR/SCROLL keys can be used to scroll through the measurement results one at a time.

### **Measurement Result Identifiers**

There are a series of letters which appear on the Result Display to identify measurement results associated with certain features of the HP 5372A.

"E" — identifies the last result in a block of measurements and the last result in a measurement acquisition.

"I" — indicates measurement results affected by the Inhibit feature. If the measurement function is Continuous Time Interval, single-channel Frequency, single-channel Period, or Totalize, the "I" identifies measurements that had their gate time extended by an Inhibit that occurred during the measurement. These "extended" measurements are not included in statistics calculations or Histogram graph results. For Time Interval,  $\pm$  Time Interval, Externally Gated measurements, and two-channel Frequency or Period

measurements, the "I" identifies measurements that occur immediately after an Inhibit condition is de-asserted. Any measurements interrupted by an Inhibit condition are discarded. (See chapter 10, "Pre-trigger Menu," for more on Inhibit.)

"P" — indicates the measurement result preceded by a pre-trigger event. (See chapter 10, "Pre-trigger Menu," for more on Pre-trigger.) If the source of the pre-trigger event is TI Detect, the "P" indicates the interval which met the conditions specified.

"T" — identifies the time between the block arming edge and the first measurement sample that is collected. (See chapter 5, "Arming," Measurements Referenced To The Block Arming Edge, for a description of this feature.)

## STATISTICS DISPLAY

Figure 15-2.  
Statistics Display

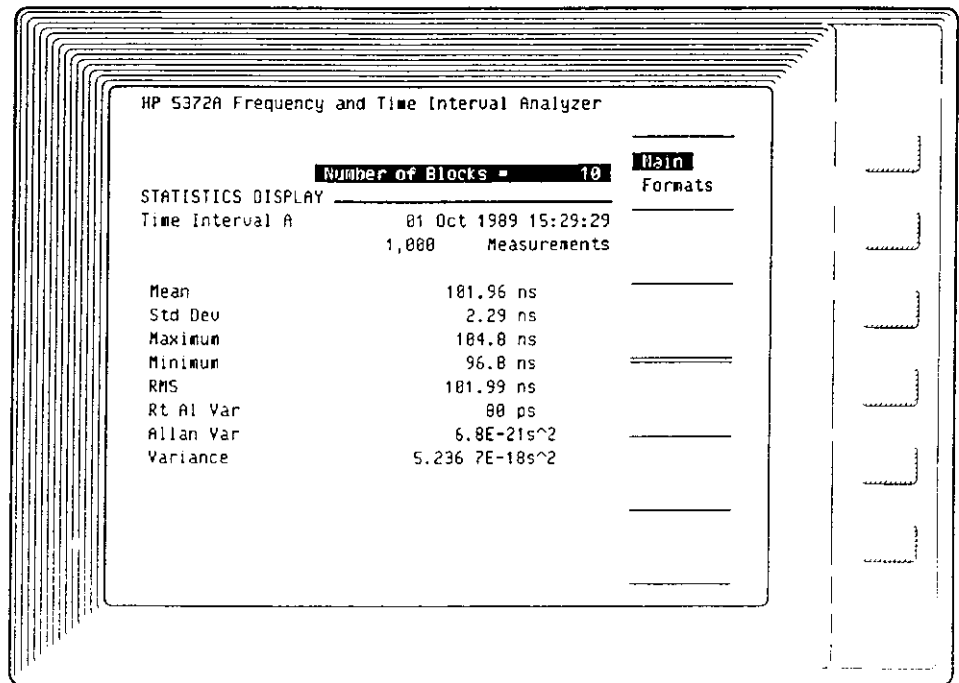

The Statistics Display shows eight statistical results. Statistics are enabled on the Math menu. The values are computed for each block of measurements. When the number of blocks is set greater than one, the statistics include the total number of measurements.

It should be noted that when statistical results are output to a printer using the PRINT function, or to a controller as part of an HP-IB program, the order of the statistical results output is different from the order on the display screen. The list below shows the sequence differences.

Display Screen Order	HP-IB Data Output Order
Mean	Mean
Standard Deviation	Standard Deviation
Maximum	Maximum
Minimum	Minimum
RMS	Variance
Root Allan Variance	Root Allan Variance
Allan Variance	RMS
Variance	Allan Variance

**Numeric Parameter field**

The numeric parameter at the top of the display can be modified on this screen.

**RESULT/STATISTICS DISPLAY**

Figure 15-3.  
Result/Statistics Display

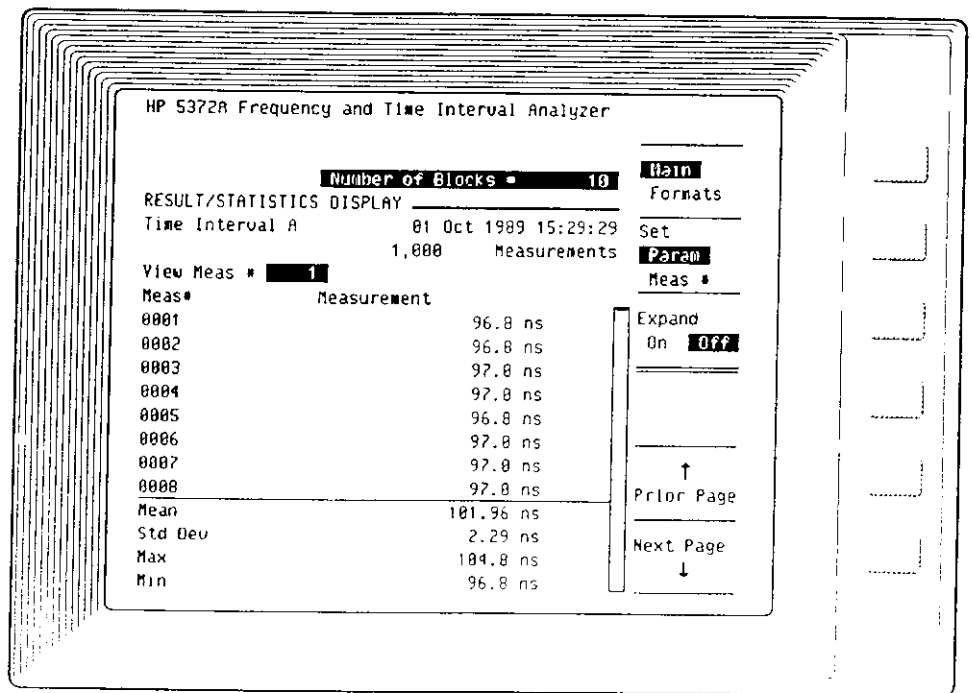

This screen is a combination of the previous two displays. Fewer measurements and statistics values are listed here. The softkey options are the same as for the Result Display.

## LIMIT STATUS DISPLAY

Figure 15-4.  
Limit Status Display

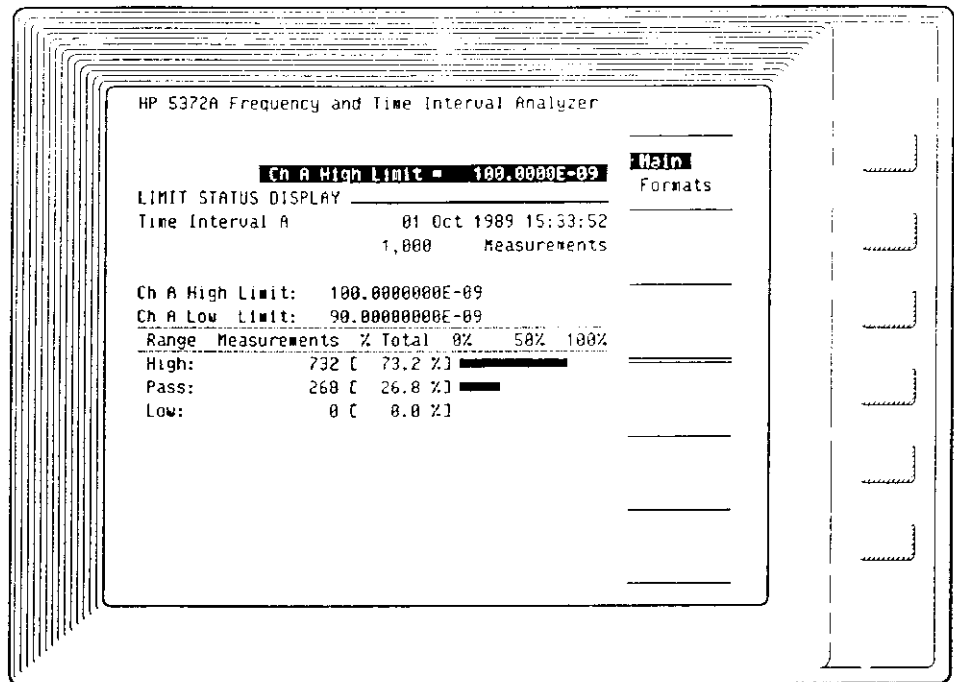

Limits are defined by the high and low values entered on the Math menu. The Limit Status display shows:

- the high and low limit values
- the number of measurements that exceeded the high value, were below the low value, and the number of measurements within the set limit range
- the number of measurements in each of the three categories (high, pass, low), expressed as a percentage of the total number of measurements
- If the lower limit is set above the upper limit on the Math menu, any result falling inside these reversed limits will be indicated with an "Ins" label. This is considered out of range. The result will be labeled "Pass" if it falls outside the limit values.

It is also possible to modify the numeric parameter displayed at the top of the screen.



## BOLD DISPLAY

Figure 15-5.  
Bold Display

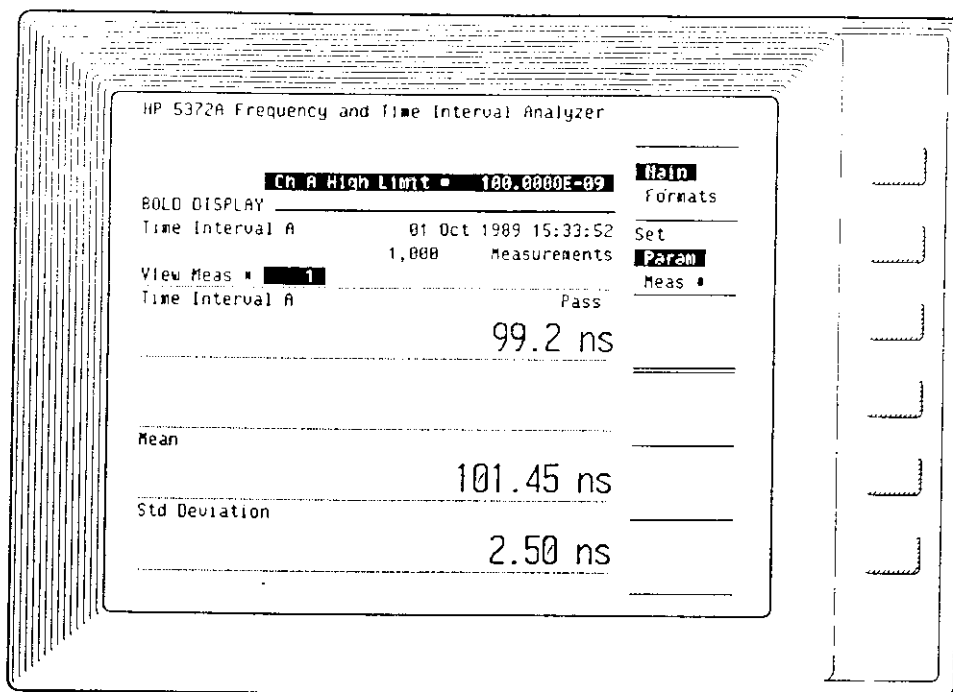

The Bold Display is convenient for viewing measurement results from a short distance away. A result from each measurement acquisition is displayed. If Statistics is enabled, the mean and standard deviation for all measurement data are shown as well. If Limits are enabled, the limit status for the displayed measurement is also shown.

### Set Param/Meas # Softkey

The softkey allows selection of the measurement number for display, or modification of the the numeric parameter at the top of the display.





000000

)

)



## Contents of Chapter

---

Chapter Overview .....	16-1
Menus .....	16-2
Main Options .....	16-3
Active Graph .....	16-3
Grid Lines .....	16-4
Outline/Connect Data .....	16-4
Show Graph .....	16-5
Copy Graph .....	16-6
Marker Options .....	16-7
Moving the Markers .....	16-7
Scrolling the Graph .....	16-8
Marker Selection .....	16-8
Marker Orientation .....	16-9
Marker Display .....	16-10
Marker Next .....	16-13
Move Marker to Maximum .....	16-14
Move Marker to Minimum .....	16-14
Move Inactive Marker to Active Marker .....	16-15
Zoom Options .....	16-16
Zoom In .....	16-16
Zoom Out .....	16-17
Full Scale .....	16-17
Display Options .....	16-18
Update .....	16-18
View Channel .....	16-19
Scaling Options .....	16-20
Yscale .....	16-20
Manual Scale X-axis .....	16-21
Manual Scale Y-axis .....	16-21
Autoscale Range Hold .....	16-21
Marker Range Hold .....	16-22
Histogram Graph .....	16-22
Histogram Main Options .....	16-24
Histogram Marker Options .....	16-25
Histogram Zoom Options .....	16-28
Histogram Display Options .....	16-29

Histogram Scaling Options .....	16-33
Limit Lines And Histogram .....	16-37
Time Variation Graph .....	16-37
Time Variation Main Options .....	16-39
Time Variation Marker Options .....	16-40
Time Variation Zoom Options .....	16-45
Time Variation Display Options .....	16-46
Time Variation Scaling Options .....	16-48
Block Averaging and Time Variation Graph .....	16-49
Measurements That Provide Averaged Results .....	16-50
Timing Information .....	16-51
Numeric Screen Timing .....	16-52
Time Variation Graph Timing .....	16-52
Limit Lines on Time Variation .....	16-53
Pre-trigger and Time Variation .....	16-54
Measurement Inhibit on Time Variation .....	16-54
Event Timing Graph .....	16-55
Event Timing Main Options .....	16-57
Event Timing Marker Options .....	16-57
Event Timing Zoom Options .....	16-58
Event Timing Display Options .....	16-59
Event Timing Scaling Options .....	16-59
Preset Values .....	16-59
Saved Parameters .....	16-60

## GRAPHIC RESULTS

CHAPTER  
OVERVIEW

This chapter describes the graphics features for analyzing the data collected by the HP 5372A. These features operate on the three data graphs that display measurement data. The three graphs are:

- Histogram
- Time Variation
- Event Timing

The sequence for discussing the graphics features is as follows:

- A general description of the graphics features and how they apply to each of the graphs.

Figure 16-1.  
Main Menu for a Time  
Variation Graph

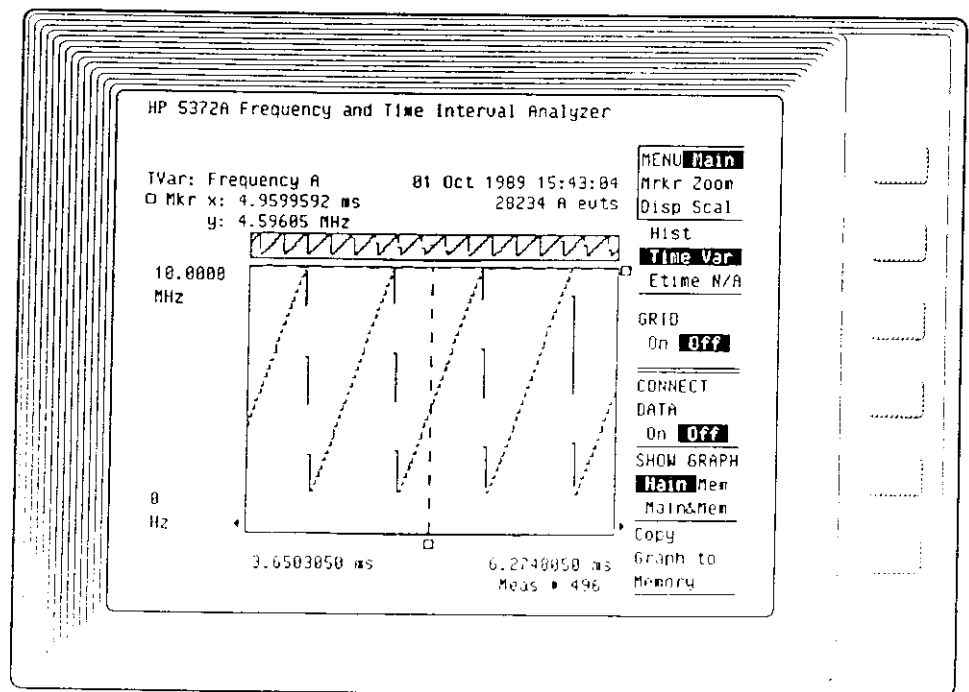

- A description of the graphs, including how to use the features available for each graph.
- The default settings for the graphics features.
- The graph parameters saved when an instrument setup is stored into memory, or when the instrument is switched off.

## MENUS

The graphic features are organized into five menus accessed with the **Graphic** key. Each menu contains related features. Not all features are supported for all three graphs. Where a feature is not available, "N/A" or "Not Avail" is part of the softkey label. These exceptions are noted where appropriate.

The five menus are:

- Main Options
- Marker Options
- Zoom Options
- Display Options
- Scaling Options

The individual graphics features are a combination of single and multiple softkey options. Where a softkey presents more than one option, the currently active choice is shown in inverse video. Pressing the softkey will cause the next option to become active. The inverse video will highlight the current selection.

When a softkey presents only one option (no inverse video), the feature has only one action, such as copying the graph to memory, or moving the marker to the minimum graph value. These softkeys may be pressed more than once in succession, but subsequent presses have no effect unless intermediate actions have caused the data or configuration to change.



**MAIN OPTIONS**

This menu contains softkeys for selecting the graph to display, enhancing the display of data, and saving a graph to allow later comparison with another.

Figure 16-2.  
Main Menu Options

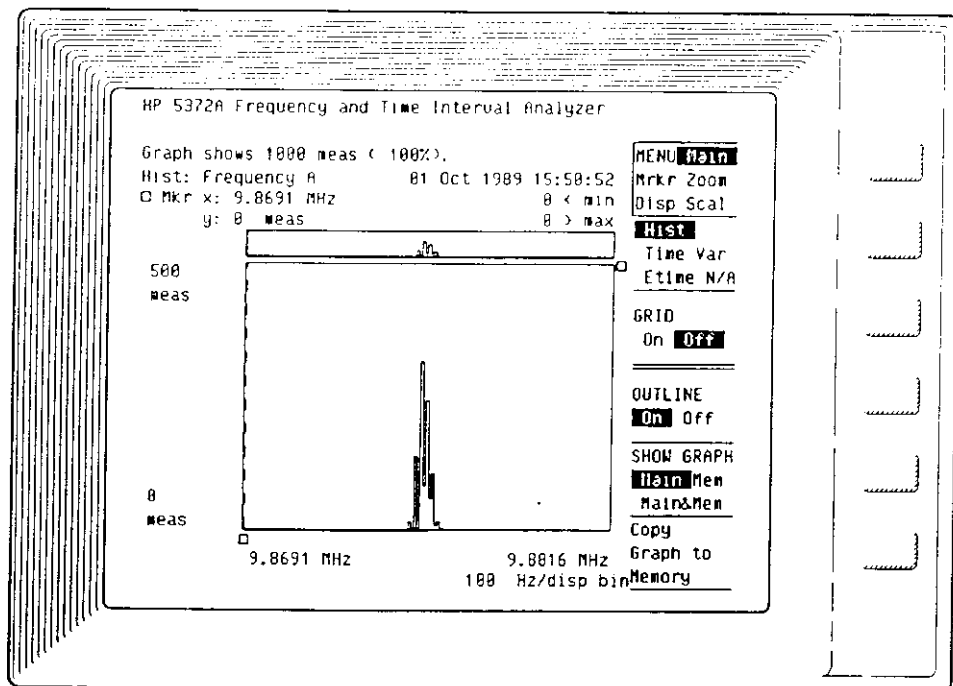
**Active Graph**

**Hist**  
**Time Var**  
**Evt Time**

This softkey selects the graph to display. The choices are the Histogram, Time Variation, or Event Timing graph.

**Comments:**

The Event Timing graph is not available for Frequency, Period, Totalize, and Phase measurement functions.

The Time Variation and Event Timing graphs are not available for the Histogram measurement functions (these are Histogram Time Interval, Histogram Continuous Time Interval, and Histogram  $\pm$  Time Interval).

## Grid Lines

### GRID On Off

Grid lines can be overlaid on the displayed graph to give you reference points for the measurement data. This feature can make interpreting data results easier.

- The Histogram graph is divided by four horizontal lines, and the display shows the number of measurements per division of the y-axis.

#### Comments:

The grid lines are different for Log scaling (selected on the Scaling Options menu). The number of horizontal lines depends on the decade values covered. For example, when the Histogram's y-axis covers 0 to 1,000 measurements in the Log scaling mode, horizontal lines appear at the 1, 10, and 100 measurement points on the y-axis.

- The Time Variation graph is divided by four horizontal lines and nine vertical lines. The display shows a range of frequency, time, %, number of events, or degrees per division along the y-axis. The type of units depends on the measurement function.
- The Event Timing graph is divided by nine vertical lines. The spacing of the lines is not referenced to the displayed measurement results.

## Outline/Connect Data

- When the Histogram graph is selected, the softkey is:

### OUTLINE On Off

The Outline feature's default value is On. It allows the graph to be drawn faster by eliminating the vertical lines of adjoining histogram bins. The first bin in a group will have a line drawn on its left side from the top of the bin to the x-axis. The last bin in a group will have a line drawn on its right side from the top of the bin to the x-axis. The bins in between are connected only by lines at the top. When Off, each bin is drawn individually.

- When the Time Variation graph is selected, the softkey is:

CONNECT

DATA

On Off

The Connect Data feature enables a “connect-the-dots” display of the measurement data. Lines are drawn on the display to connect each pair of consecutive data points. No interpolation is done. This is just a linear connection of data points.

#### Comments:

Measurements that have some discontinuity in the data acquisition are not connected. The special cases are:

1. There is no connecting line between blocks of a multiple block measurement sequence where all blocks are displayed.
  2. There is no connecting line between measurements that are interrupted by an Inhibit condition.
  3. There is no connecting line between measurements on either side of an invalid measurement result (1E+38).
  4. There is no connecting line between a time stamp of the holdoff edge and the first measurement of the block.
- The Event Timing graph has no comparable feature.

### Show Graph

SHOW GRAPH

Main Mem

Main&Mem

This softkey lets you select:

- Main — display the current graph
- Mem — display a stored graph
- Main&Mem — display current and stored graphs simultaneously

The Main graph is the graph containing the data of the most recently acquired measurement sequence. It can be a Histogram, Time Variation, or Event Timing graph.

The Memory graph is a graph that has been stored in memory. Only one graph can be stored at any time. The graph memory is cleared each time the Preset key is pressed, or the instrument is switched off. If you select the Mem feature when no graph has yet been stored, the current graph will automatically be copied into memory.

No actual data is stored for the graph, so no manipulation of the memory graph is possible. Just a copy of the current graph display is stored. The parameters saved with the graph are limited. The axes values, the header information describing the type of graph, and the date and time the data was captured are preserved.

The Main&Mem feature displays both the Main graph and the Memory graph. The graph in memory is displayed at a lower brightness level than the Main graph. None of the Memory graph parameters are displayed when the two graphs are shown simultaneously.

For all the graph types, the Main graph and the Memory graph are superimposed along the same axis.

## **Copy Graph**

### **Copy Graph to Memory**

This softkey will store the current graph in memory, overwriting whatever was previously saved. The current graph is stored without markers or limit lines. None of the graphics features can be used on the Memory graph.

## MARKER OPTIONS

Four markers are available to identify specific graph data, to set boundaries on data of interest, or to scroll the graph data on the display. There are two markers that move from side to side ( $\leftrightarrow$  □  $\leftrightarrow$  ●), and two that move from top to bottom ( $\updownarrow$  □  $\updownarrow$  ●). The  $\updownarrow$  □  $\updownarrow$  ● markers are not available for Event Timing graphs.

The markers are presented as dashed lines in the graph display area. Use the front-panel Entry/Marker knob to move the markers.

Figure 16-3.  
Marker Options Menu

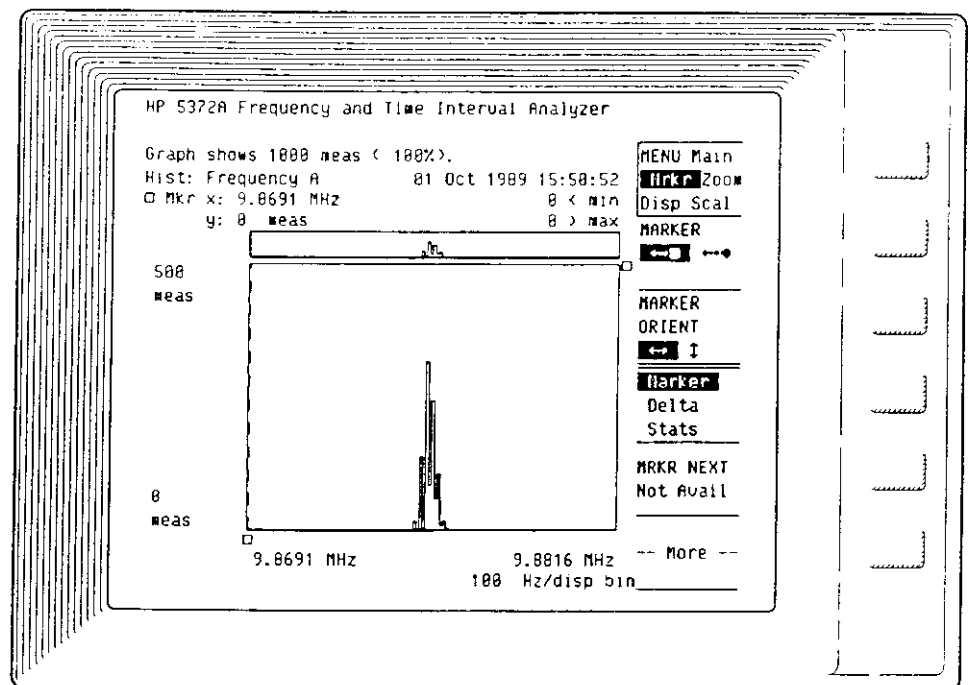

## Moving the Markers

Only one marker can be selected at any time. It is called the "active" marker. The active marker is moved by rotating the front-panel Entry/Marker knob. As the marker is moved, the coordinates of its current location are displayed above the graph. When the active marker reaches the right or left edge of the display, and there is no more data off the display, continuing to rotate the knob will have no effect. If there is data off the display, it will be scrolled into the display area as the marker is moved in that direction.

## Scrolling the Graph

This refers to bringing a new portion of the graph into the display area. As long as there is data off the display, the right or left Cursor/Scroll keys can be used to “move” the display area by one display width in the direction selected. This method can be faster than using the markers to go to a particular portion of a graph, especially if the data is fairly evenly distributed. If the entire graph is already displayed, pressing these keys will have no effect.

If there is no data in the display width span immediately to the left or right of the current display, the display will eventually skip to the next display width span that does contain data. For sparse distributions, the search process can be slow. The “Re-calculating graph...” message indicates the search is underway.

## Marker Selection

**MARKER**

↔ □ ↔ ●

or

**MARKER**

↑ □ ↑ ●

This softkey selects the active marker. The softkey choices depend on the setting of the Marker Orientation softkey below this one. Only one marker is active at any time. The markers are referred to as the “square” marker (black in the center) or the “circle” marker (white in the center). Each can have a vertical or horizontal orientation. The arrows beside the marker symbols indicate the direction the markers can be moved.

↔ □ ↔ ● — markers can be moved left or right on the display and have x- and y-axis coordinate values associated with them.

↑ □ ↑ ● — markers can be moved up or down on the display and have only y-axis coordinate values associated with them.

**Comments:**

All marker movements, commands, and displays are based on the location of the active marker.

If a marker is not in the graph display area when it is selected, the portion of the graph containing that marker will be displayed.

**Marker Orientation****MARKER  
ORIENT**

↔ ↓

This softkey selects the orientation of the markers. The arrows indicate the direction that the marker travels.

- ↔□ ↔● markers define the bounds for statistics calculations on Histograms and Modulation Analysis on Time Variation graphs.
- ↓□ ↓● markers can be moved up or down and have only y-axis values associated with them. No x-axis values will be displayed. These markers are not associated with specific measurements, but with the relative location along the y-axis.

**Comments:**

The default marker orientation is ↔.

The statistics calculations on Histograms and modulation analysis on Time Variation graphs are not available when the marker orientation is set to ↓.

If the Marker Display mode is either **Stats** (statistics) or **Mod Vals** (modulation analysis values), and ↓□ ↓● markers are then selected, the Marker Display mode changes to **Marker**.

↓□ ↓● markers are not available for Event Timing graphs.

The Marker Selection and Marker Orientation softkeys are also on the Zoom Options and Scaling Options menus for your convenience.

## Marker Display

- When the Histogram graph is selected, the following softkey choices are available:

Marker  
Delta  
Stats

- When the Time Variation graph is selected, the following softkey choices are available:

Marker  
Delta  
Mod Vals

- When the Event Timing graph is selected, the following softkey choices are available:

Marker  
Delta

### Marker mode:

- $\leftrightarrow \square$   $\leftrightarrow \bullet$  markers — the x- and y-axis values at the position of the active marker are displayed.
- $\updownarrow \square$   $\updownarrow \bullet$  markers — only the y-axis value at the position of the active marker is displayed.
- Histogram graphs — the x-axis value is the center value of the histogram bin at the active marker; the y-axis value is the number of measurements in the bin at the active marker.
- Time Variation graphs — the x-axis value is the time of the measurement at the active marker; the y-axis value is the measurement result at the active marker.
- Event Timing graphs — the x-axis value is the start or stop time of the measurement, depending on the marker's location along the time line.

### Delta mode:

- $\leftrightarrow \square$   $\leftrightarrow \bullet$  markers — the Delta feature displays the difference in position of the two markers. Delta is always calculated as 'the position of the active marker' minus 'the position of the inactive marker'.



- $\leftrightarrow \square$   $\leftrightarrow \bullet$  markers — the Delta feature displays the difference in y-axis position of the two markers. There is no x-axis value available for horizontal markers.

---

### NOTE

*Delta results are always calculated as the value of the active marker minus the value of the inactive marker. For example, if the x-axis position of the active marker is to the left of the inactive marker, the 'Delta x' value will always be negative.*

---

- Histogram graphs — 'Delta x' is the difference in the center value of the two bins at the markers; 'Delta y' is the difference in the number of measurements in the two bins at the markers.
- Time Variation graphs — 'Delta x' is the difference between the time of the measurements at the two markers; 'Delta y' is the difference in the measurement results at the two markers.
- Event Timing graphs — 'Delta x' is the difference between the time of the measurements at the two markers.
- The measurement numbers associated with the delta calculations between the two markers are displayed in a message on the status line above the graph.

**Stats mode:** (only available for Histogram graphs)

- Four statistics values are displayed. They are: minimum, maximum, mean, and standard deviation. The values are based upon Histogram bin values between the  $\leftrightarrow \square$   $\leftrightarrow \bullet$  markers (including the bins at the markers). See the Note on the next page.

---

**NOTE**

---

*Histogram statistics (as opposed to the statistics available on the Numeric screen) are bin-value derived, not measurement-value derived. The reason is that for measurement sequences of more than one block, not all of the data is available to calculate statistics using every measurement value. The statistics displayed here (on the Graphic screen) will not precisely match those displayed on the Numeric screen for the same measurement sequence. This is because the histogram statistics are limited by the bin resolution. All measurements are assumed to lie at the center of the histogram bin.*

---

- Minimum: the center value of the left-most bin enclosed by the markers.
- Maximum: the center value of the right-most bin enclosed by the markers.
- Mean (calculated as shown in the two steps below):
  1. The center value of each bin is multiplied by the number of measurements in that bin.
  2. The results of (1) are added together and then divided by the total number of measurements bounded by the markers.
- Standard Deviation: the standard formula is used, but the center value of each bin is used as the value of every measurement in that bin for the purposes of this calculation.
- The number of measurements used to calculate the statistics is displayed at the top of the display screen. It shows the number of measurements between the markers.

**Mod Vals mode:** (Only available for Time Variation graphs)

- Displays the following modulation parameters for the measurement data between the  $\leftrightarrow \square$   $\leftrightarrow \bullet$  markers: the peak-to-peak deviation, the modulation center value ( $\frac{1}{2}$  pk-pk), and the average modulation rate.
- Modulation values are re-computed whenever the markers are moved or another measurement acquisition takes place.

## Comments:

- The words, "not computable," will be displayed where the modulation rate normally appears when:
  1. The  $\leftrightarrow \square$   $\leftrightarrow \bullet$  markers do not have at least one cycle of the modulating signal between them.
  2. The modulation on the portion of the signal bounded by the  $\leftrightarrow \square$   $\leftrightarrow \bullet$  markers does not exhibit periodic behavior.

## Marker Next

## MRKR NEXT

## Data Pt

## Pixel

The HP 5372A CRT (cathode ray tube) can be divided into 125 columns in the horizontal direction for the display of graph data. The Marker Next feature provides two methods for scrolling the markers across the Time Variation or Event Timing graph data:

- Data Pt — the active marker moves from measurement to measurement. When many measurements are combined into the 125 data columns, such as for a measurement size of 1,000 results or more, marker movement may appear sluggish because it is moving among multiple measurements within each column. As you zoom in on a graph, the display columns have fewer and fewer data points within them, until only one data point is shown per column, or no data points are contained in a column.
- Pixel — the active marker moves from display column to display column. This can be a faster way of scrolling through the data when the data is concentrated on the display. If multiple measurements are included in a column, the marker will only indicate the first measurement to occur in time in each column. This is evident from watching the 'Meas #' readout just below the graph x-axis values as the marker is scrolled across the display.

## Comments:

This function is not available for Histogram graphs. Marker movement on Histogram graphs is from the center value of one bin to another.

**Move Marker to  
Maximum****Move  
(active) Marker  
to Maximum**

When this softkey is pressed:

- The active marker moves to the largest y-axis data point on the portion of the graph currently displayed. If there is more than one point with that value, the marker will move to the closest one.
- For Histogram graphs, the maximum value is the bin with the most measurements.
- For Time Variation graphs, the maximum value is the largest measurement value.
- For Event Timing graphs, this feature is not available.

**Comments:**

This feature will stay active for consecutive blocks of data if no other commands or key presses occur before new data is graphed. For example, if the marker is moved, it will not automatically go to the maximum value of the data displayed for the next acquired block of data.

Use  $\leftrightarrow$ □ or  $\leftrightarrow$ ● marker for precise readout of maximum value.

**Move Marker to  
Minimum****Move  
(active) Marker  
to Minimum**

When this softkey is pressed:

- The active marker moves to the smallest y-axis data point on the portion of the graph currently displayed. If there is more than one point with that value, the marker will move to the closest one.
- For Histogram graphs, the minimum value is the bin with the fewest measurements (zero is the smallest value).
- For Time Variation graphs, the minimum value is the smallest measurement value.
- For Event Timing graphs, this feature is not available.

**Comments:**

This feature will stay active for consecutive blocks of data if no other commands or key presses occur before new data is graphed. For example, if the marker is moved, it will not automatically go to the minimum value of the data displayed for the next acquired block of data.

Use  $\leftrightarrow \square$  or  $\leftrightarrow \bullet$  marker for precise readout of minimum value.

**Move Inactive  
Marker to Active  
Marker****Move (inactive marker)  
to (active marker)  
location**

When this softkey is pressed:

- The inactive marker is moved to the same display location as the active marker. The inactive marker is visible only after the active marker is moved, as the active marker is shown "on top of" the inactive marker.

**Comments:**

This is a valuable feature when you have zoomed around the active marker, leaving the inactive marker at a location outside the zoom window. Now if you want to perform a Delta or Statistics function on this portion of the graph, this feature is a convenient way to bring the inactive marker into the display.

## ZOOM OPTIONS

Zoom features for the HP 5372A make it possible to magnify a certain portion of the graph that may be of interest.

The list of Zoom Option softkeys include two that affect the markers: marker selection and marker orientation. Refer to Marker Options for a description of their operation.

Figure 16-4.  
Zoom Options Menu

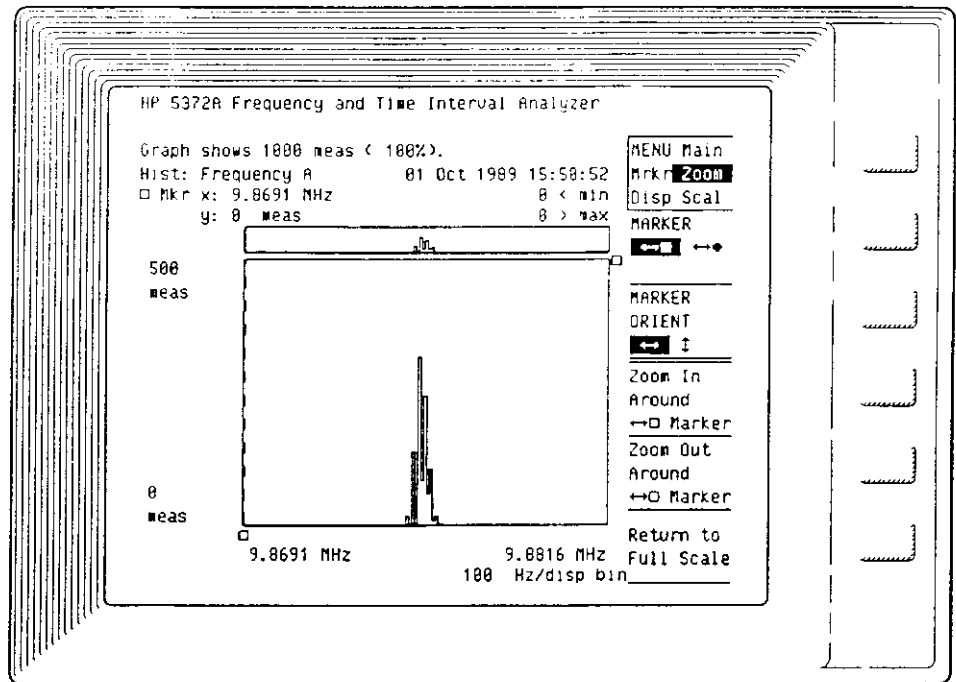

### Zoom In Around (active) Marker

- Pressing this softkey magnifies a portion of the graph, giving a close-up view of the data. The zoom action takes place around the active marker.
- Below the active marker there is a 'preview bar' that tracks the active marker and indicates the portion of the graph that will fill the graph area when the **Zoom In** softkey is pressed. This bar appears as a highlighted portion of the x-axis when using  $\leftrightarrow \square$   $\leftrightarrow \bullet$  markers.

There is also a preview bar for  $\updownarrow \square$   $\updownarrow \bullet$  markers on the Time Variation graph.

- Above the main display graph is the panorama display. It always shows all data available for viewing. When the main graph is zoomed in, the panorama display will continue to show all the data that has been graphed. A line segment under the panorama graph will be highlighted to indicate the portion of the whole graph that is currently shown in the main display area.

#### Comments:

The panorama display does not provide a detailed view, however, it will give you an idea of what portion of the data is currently displayed. In addition, displays with very concentrated data will be easier to see in this wide view. Examples are bi-modal histograms or burst data on Time Variation graphs.

↔□ ↔● markers appear on the panorama graph, while ↑□ ↑● markers do not.

The Zoom feature is not available for ↑□ ↑● markers on Histogram graphs.

### Zoom Out

#### Zoom Out Around (active) Marker

- Pressing this softkey performs the reverse of the **Zoom In** softkey. Approximately twice as much of the graph will be displayed each time the **Zoom Out** softkey is pressed.

### Full Scale

#### Return to Full Scale

- Pressing this softkey re-scales the graph to full scale, showing all data.

## DISPLAY OPTIONS

Display features are available for only the Histogram graphs and Time Variation graphs. These features affect how data will be displayed on the graphs.

Figure 16-5.  
Display Options Menu

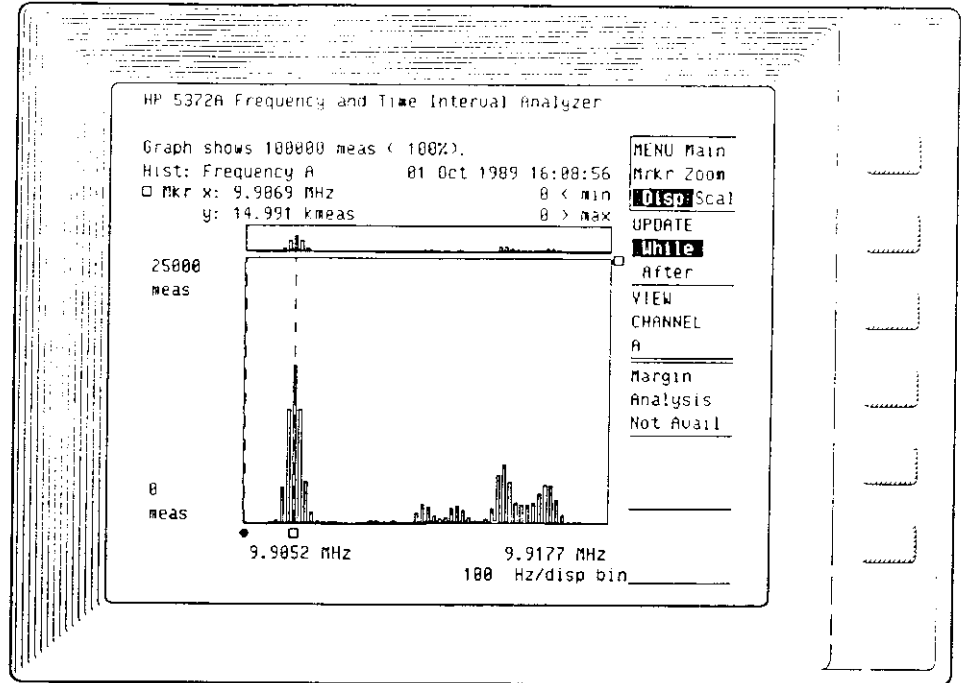

**Update**      **UPDATE**  
                  **While**  
                  **After**

This feature is available in the following instances:

- for Histogram graphs when the measurement sequence is multi-block and the total number of measurements exceeds the memory size (text on the Function menu reads, “Results will be most recently acquired block”). At the completion of the measurement sequence, the Histogram graph always contains the cumulative results.
  1. UPDATE While — will update the graph and display the accumulated results after each block is acquired. This mode is often referred to as a “growing histogram”. It is useful for observing trends after only a few blocks to help determine if the measurement is appropriate.
  2. UPDATE After — will cause the graph to display the accumulated results only after the final block of the



measurement sequence is acquired. This typically results in a faster acquisition, since time is not taken to periodically update the display during acquisition.

- for Time Variation graphs when the measurement sequence is multi-block and the total number of measurements exceed the memory size (text on the Function menu reads, "Results will be most recently acquired block").
  1. If the results are not averaged, 'Update While' will cause each block of data to be displayed as it is acquired. There is no accumulation of data across blocks. 'Update After' will cause only the last block of the measurement sequence to be displayed.
  2. If the results are being averaged (see Frequency/Period Measurements), 'UPDATE While' will cause a graph of the accumulated averaged results to be displayed after each block is acquired. The last block displayed represents the average of all the blocks acquired. 'UPDATE After' will cause only one graph to be displayed at the end of the measurement sequence. It will represent the average of all the blocks acquired.

## View Channel

### VIEW CHANNEL

A      B                      (A      C)                      (B      C)

Use this softkey to select the channel to graph when making dual-channel, dual-result measurements. These are:

- Frequency A&B, A&C, B&C (with Channel C option)
- Period A&B, A&C, B&C (with Channel C option)
- Totalize A&B

Only one channel can be graphed at a time. The softkey is used to specify which one to display. If the measurement does not provide dual results, the softkey reflects the current measurement channel, and no other selection is available.

## SCALING OPTIONS

Scaling options allow you to set the scale limits for each of the graph types. When manual scaling is off, the graphs are automatically scaled. A general description of each of the scaling features is included here, but you should refer to the graph of interest in this chapter for a detailed description of how each feature applies to the specific graph type you are using.

The Scaling Option softkeys include two that affect the markers: Marker Selection and Marker Orientation. Refer to Marker Options for a description of their operation.

Figure 16-6.  
Scaling Options Menu

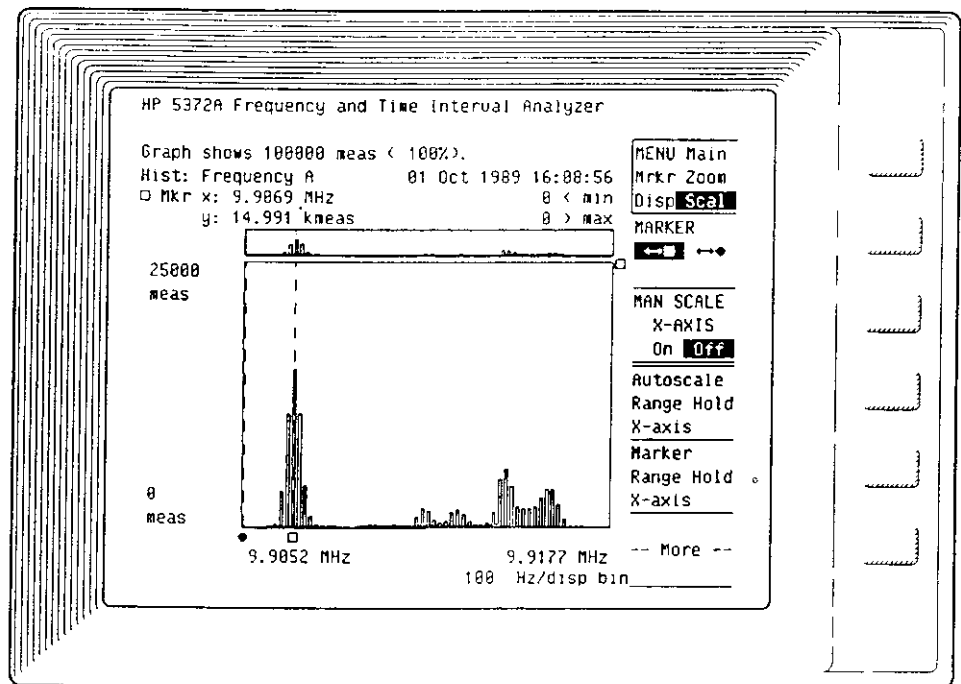

### Yscale YSCALE Log Lin

This feature allows you to select between two scaling modes for the y-axis of Histogram graphs:

- LOG — the y-axis is displayed on a logarithmic scale
- LIN — the y-axis is displayed on a linear scale

Refer to Histogram Scaling Options for more information.

**Manual Scale X-axis**      **MAN SCALE**  
**X-AXIS**  
**On      Off**

With Manual Scale X-Axis On:

- Histogram — you can set the x-axis minimum value and the bin width
- Time Variation — you can set the x-axis minimum and maximum values
- Event Timing — you can set the x-axis minimum and maximum values
- Entered numbers will default to predetermined values according to a "1-2-5" pattern.

**Manual Scale Y-axis**      **MAN SCALE**  
**Y-AXIS**  
**On      Off**

With Manual Scale Y-Axis On:

- Histogram — you can set the y-axis maximum value
- Time Variation — you can set the y-axis minimum and maximum values
- Event Timing — there are no y-axis values for this type of graph
- Entered numbers will default to predetermined values according to a "1-2-5" pattern.

**Autoscale Range Hold**      **Autoscale**  
**Range Hold**  
**X-axis (or Y-axis)**

This feature is used to copy the current autoscale axis values as the manual scaling values. Then when manual scaling is turned on, the starting points for selecting new values are the autoscaled values. This is useful to acquire a set of data, using autoscale to determine the range. Then press this softkey and turn on manual scaling. All subsequent acquisitions appear on the same scale, so results are "visually" comparable.

**NOTE**

---

*If Manual scaling is turned on and no endpoint values have been set (from previous numeric entry or Range Hold operations), the Autoscale Range Hold action automatically takes place.*

---

**Marker Range Hold**

Marker  
Range Hold  
X-axis (or Y-axis)

This feature is used to copy the values of the current marker positions as the manual scaling values. Then when manual scaling is turned on, the portion of the graph that is bounded by the markers is expanded to fill the display. New axis values can be entered at this point, if desired. This is useful as a means to use the markers to define subsequent displays. As long as the data can be seen on the graph, it is much easier to use the markers to define the scaling limits, as opposed to entering discrete values. (Note: The HP 5372A still acquires all the data, but you cannot view it while manual scaling is on.)

**HISTOGRAM  
GRAPH**

The Histogram plots the number of occurrences of measurement values versus those measurement values. The x-axis of the Histogram covers the range of measurement values; the y-axis displays the scale for the number of measurements.

The x-axis is divided into discrete ranges of values, called bins; the y-axis indicates the number of measurements in each of the bins.

**Comments:**

The Histogram graph sorts data by measured value, so the order in which the data is collected is lost. Use the Time Variation graph to display the measured values as a function of time.

Figure 16-7 shows a Histogram graph with information highlighting the organization of the graph.

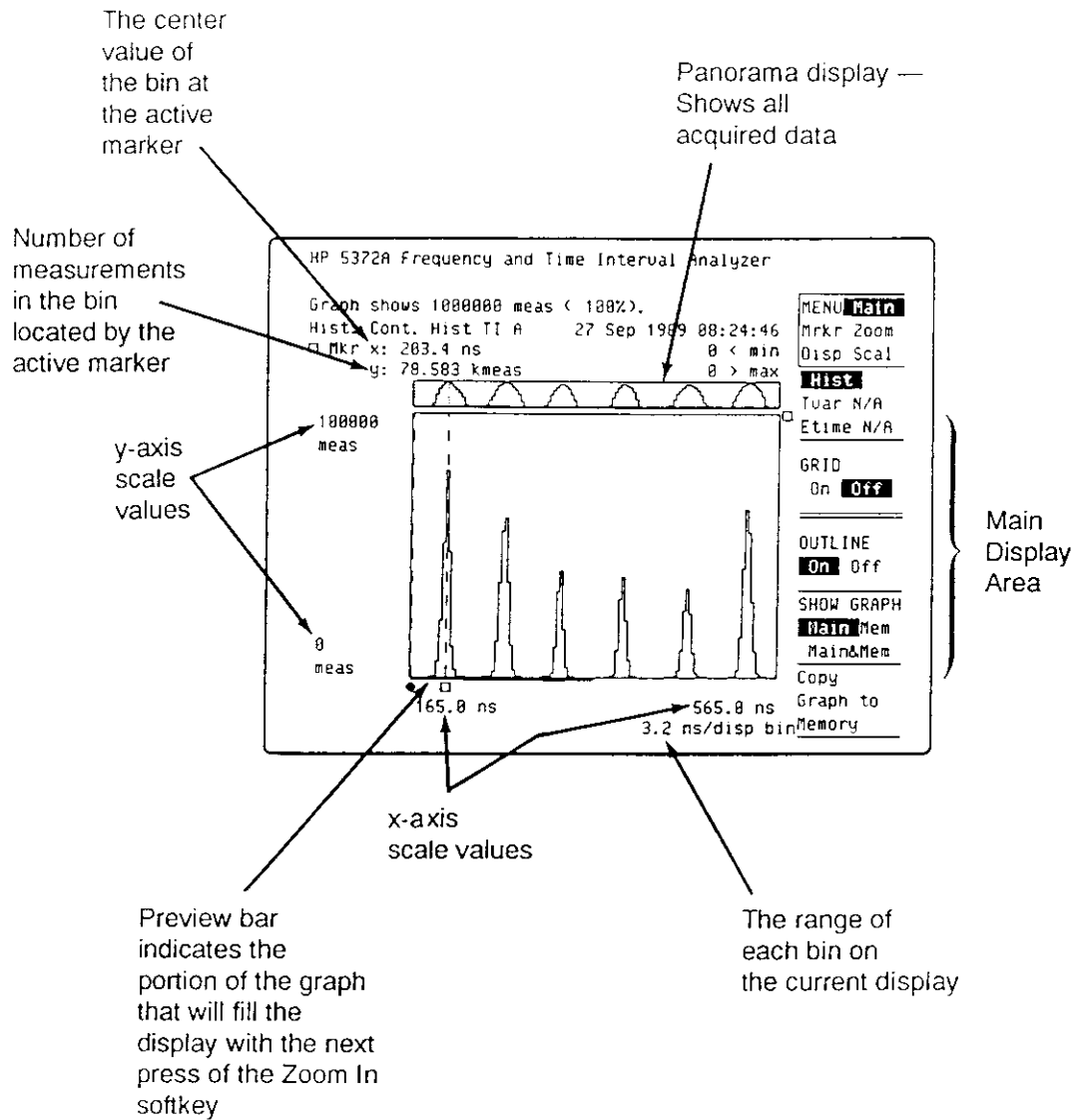

Figure 16-7. Histogram Graph Organization

## Histogram Main Options

- Grid
- Outline

### GRID:

- The spacing depends on the y-axis scaling mode (Yscale feature set on the Scaling Options menu). The mode can be Linear or Log.
- Linear — the graph is divided by four horizontal lines. A label appears to the left of the graph showing the number of measurements per division.
- Log — the horizontal line spacing is based on the decade values covered. For example, if y-axis is scaled 0 to 1000, grid lines appear at 1, 10, and 100 measurement points. Log is useful when large measurement samples are taken and bins with few values are of interest.

See Figures 16-8 and 16-9 for a comparison of the Linear and Log scales using the same graph data.

Figure 16-8.  
Histogram Linear  
Scale

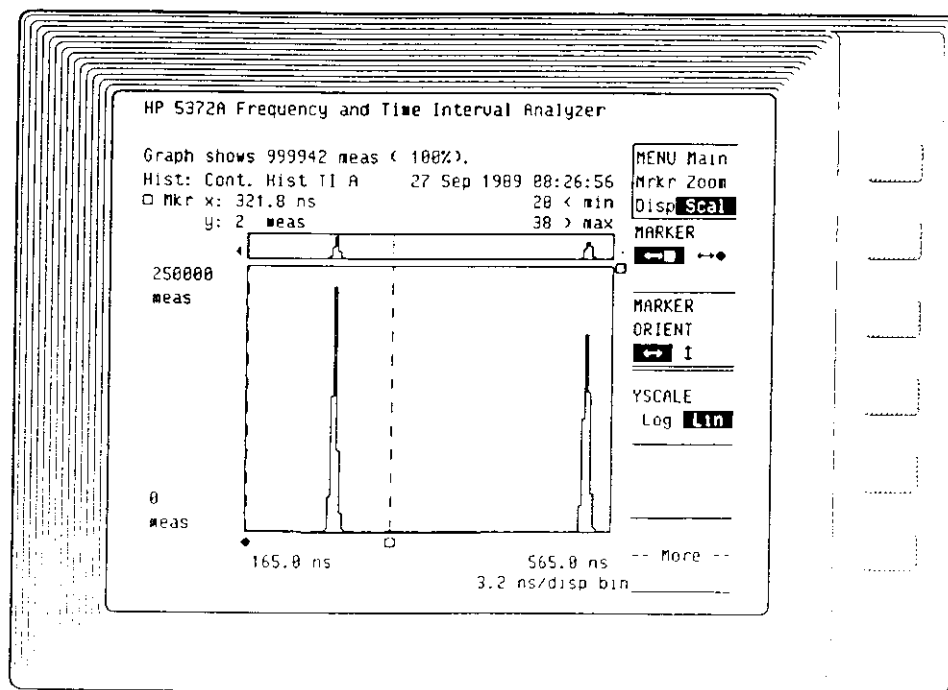
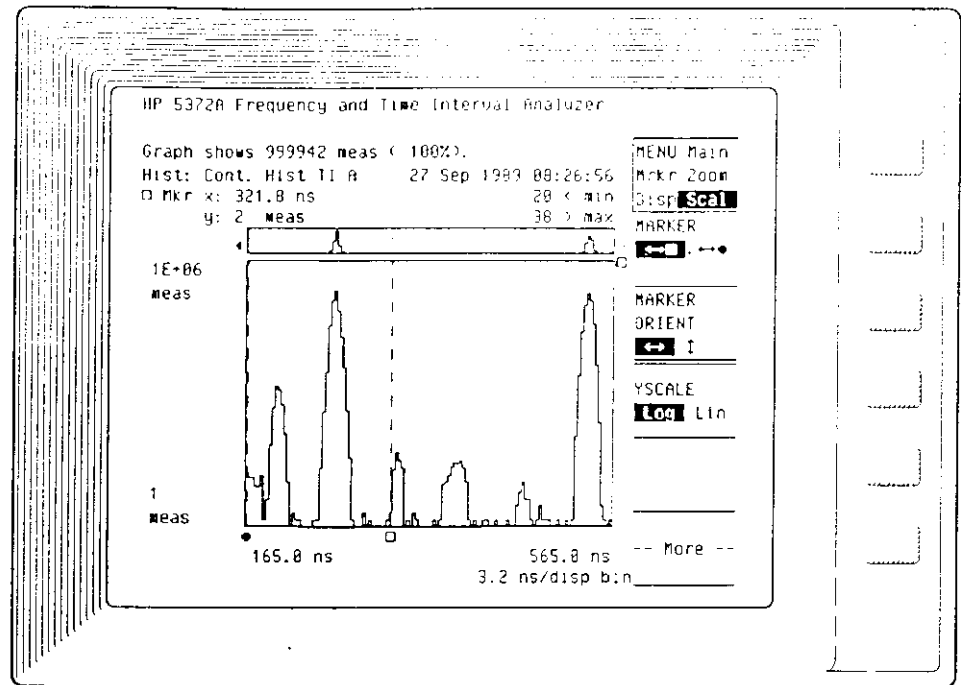

Figure 16-9.  
Histogram Log  
Scale (same data as  
Figure 16-8)



#### OUTLINE:

- OUTLINE On is the default condition. Each Histogram bin will have lines connecting the top of that bin to the top of adjoining bins. This way the graphs can be drawn faster.
- OUTLINE Off provides vertical lines drawn for each Histogram bin from the bin top to the x-axis of the graph.

#### Comments:

When using the SHOW GRAPH features to view two Histograms simultaneously, they are easier to distinguish if one is displayed with Outline On and one with Outline Off.

### Histogram Marker Options

- Marker
- Delta
- Statistics
- Marker to Maximum
- Marker to Minimum

**MARKER:**

- The  $\leftrightarrow \square \leftrightarrow \bullet$  markers provide an x-axis value for the bin at the marker and the number of measurements in the bin.
- The  $\updownarrow \square \updownarrow \bullet$  markers display a number of measurements dependent on the position of the markers relative to the y-axis scale, not the measurement data.

**DELTA:**

- Delta on the  $\leftrightarrow \square \leftrightarrow \bullet$  markers is the difference in the center value of the two bins at the markers (x-axis values), and the difference in the number of measurements in the two bins at the markers (y-axis values).
- Delta on the  $\updownarrow \square \updownarrow \bullet$  markers is the y-axis difference in the position of the two markers.
- The measurement numbers associated with the delta calculations between the two markers are displayed in a message on the status line.

**NOTE**

---

*Delta results are always calculated as the value of the active marker minus the value of the inactive marker. For example, if the x-axis position of the active marker is to the left of the inactive marker, the 'Delta x' value will always be negative.*

---

**STATISTICS:**

- Four statistics values are displayed. They are: minimum, maximum, mean, and standard deviation. The values are based upon Histogram bin values between the two markers (including the bins at the markers).



---

**NOTE**

---

*Histogram statistics (as opposed to the statistics available on the Numeric screen) are bin-value derived, not measurement-value derived. The reason is that for measurement sequences of more than one block, not all of the data is available to calculate statistics using every measurement value. The statistics displayed here (on the Graphic screen) will not precisely match those displayed on the Numeric screen for the same measurement sequence. This is because the histogram statistics are limited by bin resolution. All measurements are assumed to lie at the center of the histogram bin.*

---

- **Minimum:** the center value of the left-most bin enclosed by the markers.
- **Maximum:** the center value of the right-most bin enclosed by the markers.
- **Mean:**
  1. The center value of each bin is multiplied by the number of measurements in that bin.
  2. The products of (1) are added together and then divided by the total number of measurements bounded by the markers.
- **Standard Deviation:** the standard formula is used, but the center value of each bin is used as the value of every measurement in that bin for the purposes of this calculation.
- The number of measurements used to calculate the statistics is displayed at the top of the display screen. It shows the number of measurements between the markers.

**MOVE MARKER TO MAXIMUM:**

- The active marker moves to the tallest bin (the one with the most measurements) on the portion of the graph that is currently displayed.

**MOVE MARKER TO MINIMUM:**

- The active marker moves to the shortest bin (the one with the least measurements) on the portion of the graph that is currently displayed. If any bin contains no measurements, that is the minimum.

**Histogram  
Zoom Options**

- Zoom In/Out

**ZOOM IN:**

- Pressing this softkey magnifies a portion of the graph, giving a close-up view of the data. The zoom action takes place around the active marker.
- Panorama display above the main display area always shows all the data that is available for viewing. There is a highlighted line segment under the panorama display that indicates the portion of the whole graph that is currently shown in the main display area.
- Use the **Return to Full Scale** softkey at any time to display all the measurement data that has been graphed.

**ZOOM OUT:**

- The **Zoom Out** softkey performs the reverse of the **Zoom In** softkey. Approximately twice as much of the graph will be displayed each time the **Zoom Out** softkey is pressed.

**Comments:**

You can zoom in on data of interest between two markers with a feature in the Scaling Options. Use the following steps:

1. Set markers to enclose data of interest.
2. Go to Scaling Options and press **Marker Range Hold X-axis** softkey.
3. Set Manual Scale to On.

## Histogram Display Options

- Update
- View Channel

### UPDATE:

The Update feature is available for Histograms when measurement sequences are multi-block AND the total number of measurements exceeds measurement memory. This is indicated by text on the Function menu that reads as follows:

1. "Results will be most recently acquired block"

OR

2. "Display Averaged Results from all blocks," with the "Averaged Results" field locked-out, that is, it is not selectable with the menu cursor.

Figure 16-10 shows a setup where UPDATE is not offered. Figure 16-11 shows a setup where UPDATE While or After is available.

Figure 16-10.  
UPDATE is Not Available

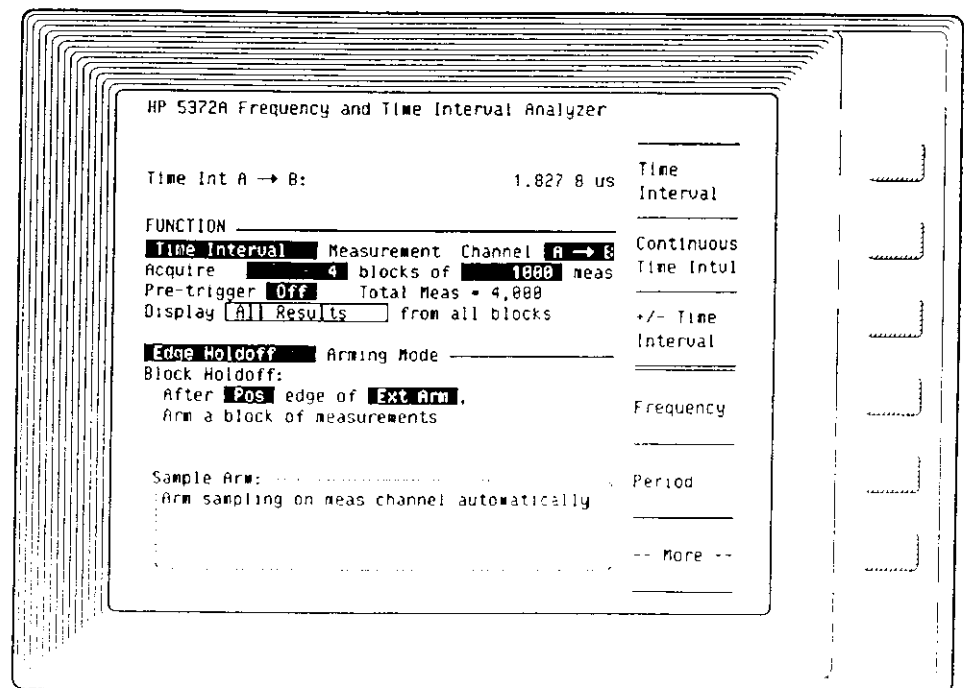
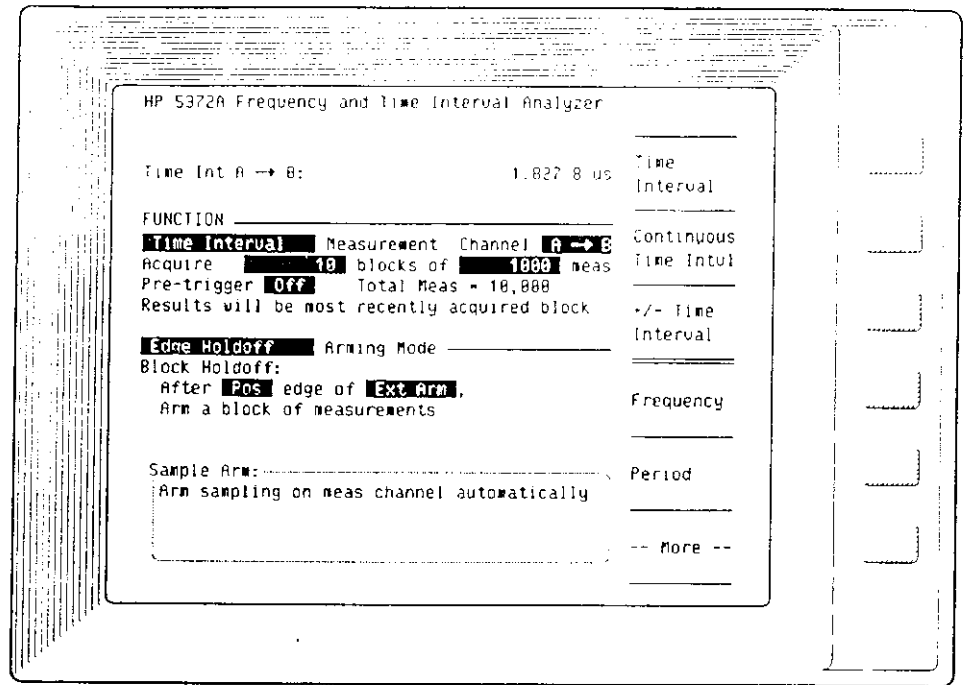

Figure 16-11.  
UPDATE While or After  
Selection is Available



- UPDATE While — the Histogram is updated after each block to reflect the cumulative data. This mode is sometimes referred to as a “growing histogram.” It is useful for observing trends after only a few blocks to help determine if the measurement is appropriate.

---

**NOTE**

*When making a multiple block measurement using autoscaling, the overall range of the x-axis is determined with the first block of data. If a subsequent block in the same measurement sequence has data that falls outside the range set after the first block, those data points will not be included in the Histogram.*

*When this happens, there will be an arrowhead to the left and/or right of the panorama display. The arrowhead indicates that data was collected outside the graph boundaries, and cannot be graphed. The number of measurements that fell outside the graph limits is listed above the panorama display ( $M < \min$ ,  $N > \max$ ).*

*To ensure that all data falls inside a given range on the Histogram, use manual scaling to set the graph boundaries.*

*This note applies only to non-Histogram measurements. Histogram measurements have no autoscaling feature. Refer to chapter 4, "Histogram Measurements," for more information.*

---

- **UPDATE After** — the Histogram is not displayed until all blocks of data have been collected. This is a faster mode of operation for multiple-block measurements because the graph is only drawn once. The disadvantage is that no results are observable until the end of the measurement sequence. For a large number of blocks, this could take quite some time. During the acquisition, the current number of blocks collected is displayed on the Numeric screen.

---

**NOTE**

*When using autoscaling, the x-axis endpoints are determined based on only the first block of data. See the Note under Update While.*

---

All the data from the measurement sequence is graphed in the Histogram, as long as all the data falls within the boundaries of the graph. There are a total of 2,000 bins for the Histogram. When data is not graphed, the number of measurements outside the Histogram bounds will be noted above the panorama display. See the example in *Figure 16-12*.

Figure 16-12.  
Not All Data Graphed

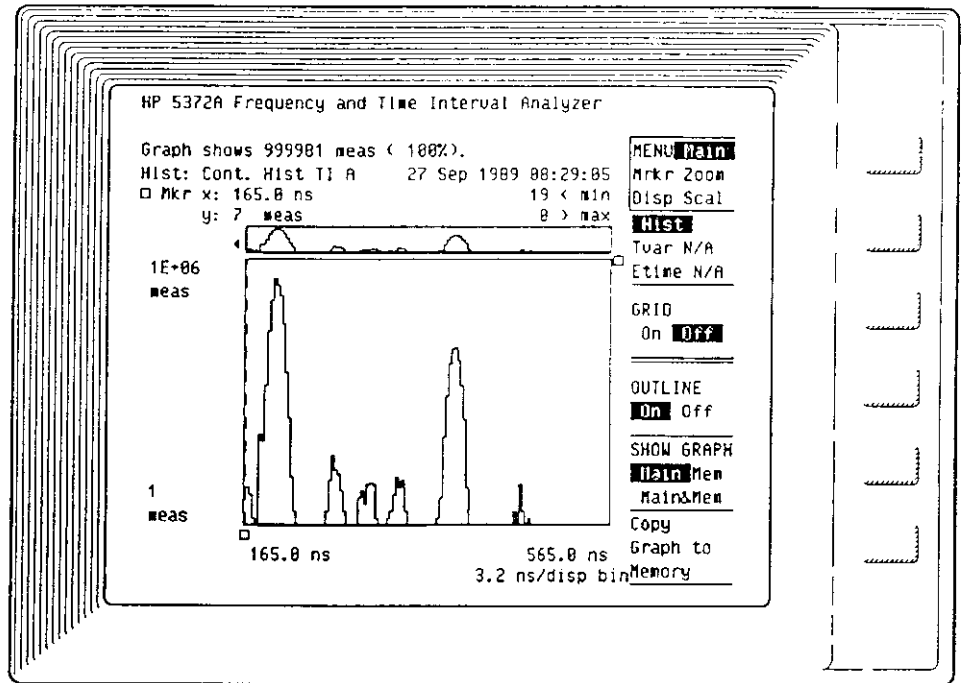

**VIEW CHANNEL:**

- For dual-channel, dual-result measurements, such as: Frequency or Period A&B, Totalize A&B, you can select one or the other channel to graph.

## Histogram Scaling Options

- Log or Linear scale
- Manual Scaling

Histogram graphs can be scaled in both the x and y directions. The x-axis describes the range of measurement values. The y-axis describes the number of measurements. Bins are drawn along the x-axis, with the range of each bin also called, "bin width." The height of the bins are determined by the number of measurements falling within the range defined by each bin. For any data point on the graph:

- the x-axis coordinate is the center value of the data bin,
- the y-axis coordinate is the number of measurements in the bin.

### Y-AXIS LOG OR LINEAR SCALE MODE:

- The y-axis scale can be set to Log or Linear mode. The default is Linear scaling. Log scaling is especially useful for large sample sizes, because the logarithmic scale tends to compress the large bin values and expand the small ones, allowing all components of the graph to be displayed at the same time. Large sample sizes are easily generated with the Histogram measurements. These measurements are described in chapter 4, "Histogram Measurements."

### LINEAR AUTOSCALING:

- The y-axis minimum is defined as 0. The y-axis maximum is internally selected, based on the maximum bin value of the Histogram. All bin heights are scaled relative to that maximum value. The autoscaling algorithm defines y-axis values on a "1-2-5" pattern. For example, if the maximum bin height is 4, the y-axis maximum is 5; a height of 7 would force a scale maximum of 10; a height of 18 would force a scale maximum of 25. From 25, the progression of values is 50, 100, 250, 500, 1000, etc.

**Comments:**

When you enter manually scaled values for the y-axis, the y-axis maximum value will default to one of the pre-defined 1-2-5 pattern values. For example, if you enter 1200, the y-axis maximum value will default to 2500, the next higher pattern value.

- The x-axis limits are determined by the actual measurement values. The first bin will have a starting value less than, or equal to, the minimum measurement value. The last bin will have an ending value greater than, or equal to, the maximum measurement value.

**NOTE**

---

*If you are making a measurement acquisition of multiple blocks, be aware that the overall x-axis limits are based upon the first block of data. It is possible that a widely varying input signal may not have all of its data graphed. The number of measurements not graphed will be shown above the panorama display. It will show the number of measurements below the minimum value and the number above the maximum value. Arrowheads will also appear alongside the panorama graph indicating that data occurred outside the boundaries of the graph.*

---

**LINEAR MANUAL SCALING:**

- The y-axis minimum is defined as 0. The y-axis maximum is specified by the user. This is done by first setting the **MAN SCALE Y-AXIS** softkey to On. Press the **Y MAXIMUM** softkey and a numeric entry field will appear below the graph. All bin heights are scaled relative to the maximum y-axis scale value.

Range: Y-axis maximum must be a positive value  $\geq 5$ . If a negative value or a positive value  $< 5$  is entered, it will be changed to 5.

Y-axis maximum must be an integer value. If a non-integer is entered, it will be rounded up to the nearest integer.

The maximum value is 1E+12. If a greater value is entered, it will default to 1E+12.



**Comments:**

When you enter manually scaled values for the y-axis, the y-axis maximum value will default to one of the pre-defined 1-2-5 pattern values. For example, if you enter 1200, the y-axis maximum value will default to 2500, the next higher pattern value. Read the description for how the scale values are automatically set for more on the 1-2-5 scale pattern.

- For the x-axis, the user enters a minimum value and a bin width. There will always be 2,000 data bins available for graph data, so the span of the graph will be:

2,000 x bin width

and the ending value will be

minimum value + (2,000 x bin width)

Error checking takes place to insure that the minimum value and the bin width satisfy the resolution requirements for the current measurement. For example, if a bin width less than the minimum resolution of the measurement is entered, the bin width will be increased as required. Also, the starting value actually used in scaling the graph will have to be the entered value rounded down to the nearest multiple of resolution.

**LOG AUTO SCALING:**

- The y-axis minimum is defined as 0. The y-axis maximum is internally selected, based on the maximum bin value of the Histogram. The maximum y-axis scale value will be the next power of 10 that is greater than the maximum bin value. For example, if the maximum bin value is 72, the maximum y-axis value is 100; a maximum bin value of 490 would force a scale maximum of 1000. All bin heights are scaled relative to the maximum graph value. Although zero is not defined for log scaled graphs, there needs to be a way to show that some bins contain no measurements. 0 appears where normally .9 appears on a Log scale graph. When the grid lines are displayed, the line representing 1 is just above the x-axis.
- The x-axis limits are determined by the actual measurement values. The first bin will have a starting value less than, or equal to, the minimum measurement

value. The last bin will have an ending value greater than, or equal to, the maximum measurement value.

### **NOTE**

---

*If you are making a measurement acquisition of multiple blocks, be aware that the overall x-axis limits are based upon the first block of data. It is possible that a widely varying input signal may not have all of its data graphed. The number of measurements not graphed will be shown above the panorama display. It will show the number of measurements below the minimum graph value and the number above the maximum graph value. Arrowheads will also appear alongside the panorama display indicating that data occurred outside the boundaries of the graph.*

---

### **LOG MANUAL SCALING:**

- The y-axis minimum is defined as 0. The y-axis maximum is specified by the user. This is done by first setting the **MAN SCALE Y-AXIS** softkey to On. Then pressing the **Y MAXIMUM** softkey will cause a numeric entry field to appear below the graph. All bin heights are scaled relative to the maximum y-axis scale value.

Range: Y-axis maximum must be a positive value  $\geq 10$ . If a negative value or a positive value  $< 10$  is entered, it will be changed to 10.

Y-axis maximum must be a power of ten. An entered value that is not a power of ten will be rounded up to the next largest power of ten.

The maximum value is 1E+12. If a greater value is entered, it will default to 1E+12.

- For the x-axis, the user enters a minimum value and a bin width. There will always be 2,000 data bins available for graph data, so the span of the graph will be:

2,000 x bin width

and the ending value will be

minimum value + (2,000 x bin width)

Error checking takes place to insure that the minimum value and the bin width satisfy the resolution requirements for the current measurement. For example, if a bin width less than the minimum resolution of the measurement is entered, the bin width will be increased as required. Also, the starting value actually used in scaling the graph will have to be the entered value rounded down to the nearest multiple of resolution.

## LIMIT LINES AND HISTOGRAM

Limit lines on histograms are two vertical lines which overlay the graph. Their positions are dictated by the limit values entered on the Math menu. One line marks the low limit, and one marks the high limit. Limit lines are displayed when:

- the Limits feature is enabled on the Math menu for the channel being measured
- the limit values are within the display range of the graph being viewed.

### Comments:

If one or both limit lines fail to appear on the graph, check the graph scale to make sure the limit values are within those spanned by the graph.

## TIME VARIATION GRAPH

The Time Variation graph plots measurement value versus the actual time of measurement. The x-axis covers the time span over which the measurements were acquired. The y-axis covers the measurement range.

*Figure 16-13* shows a Time Variation graph with information on the organization of the graph.

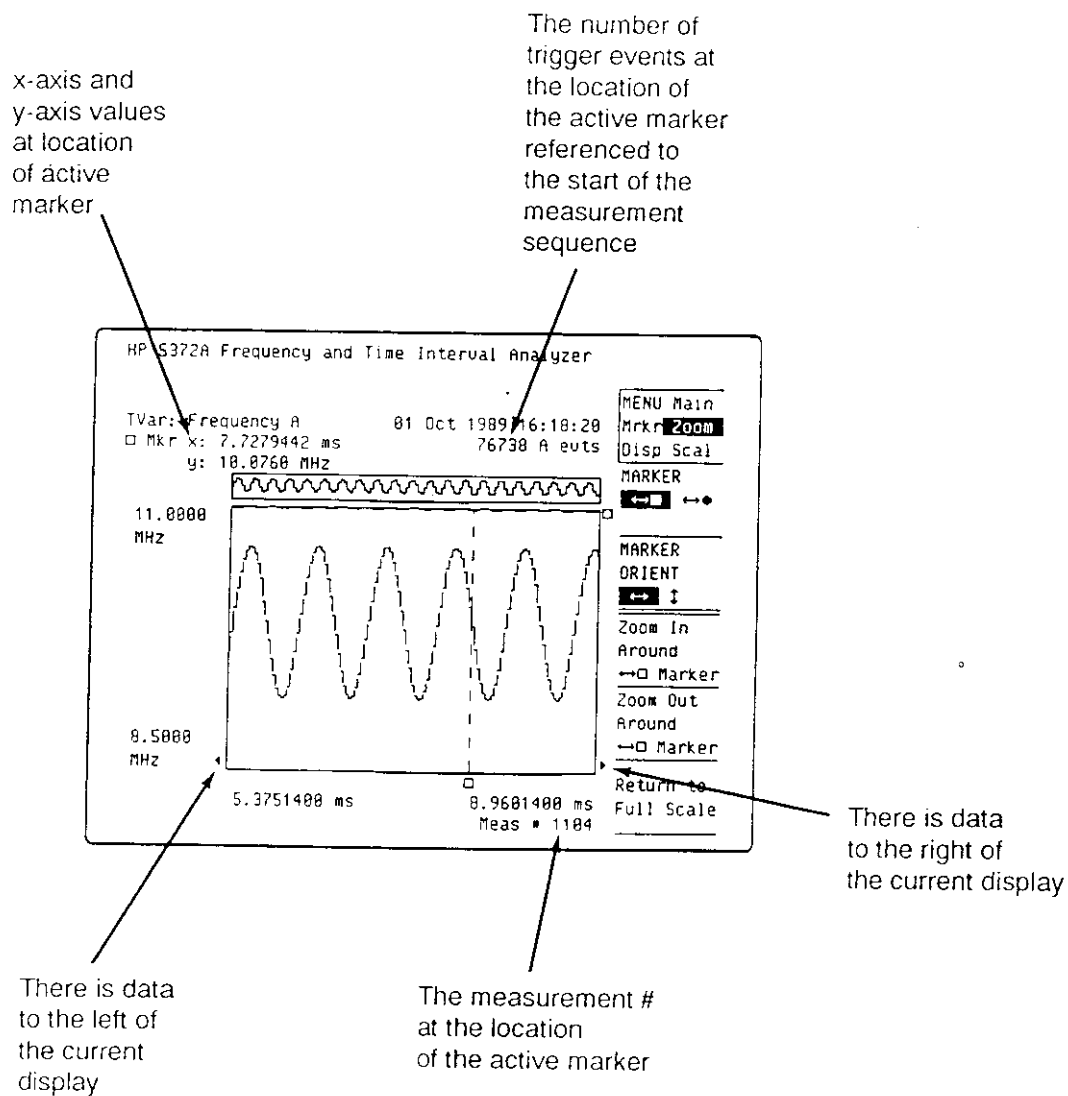

Figure 16-13. Time Variation Graph Organization

## Time Variation Main Options

- Grid
- Connect Data

### GRID:

- The graph is divided by four horizontal lines and nine vertical lines. The display shows a range of frequency, time, %, events, or degrees, per division along the y-axis. The type of units depends on the measurement function selected (see *Figure 16-14*).

Figure 16-14.  
Time Variation Grid

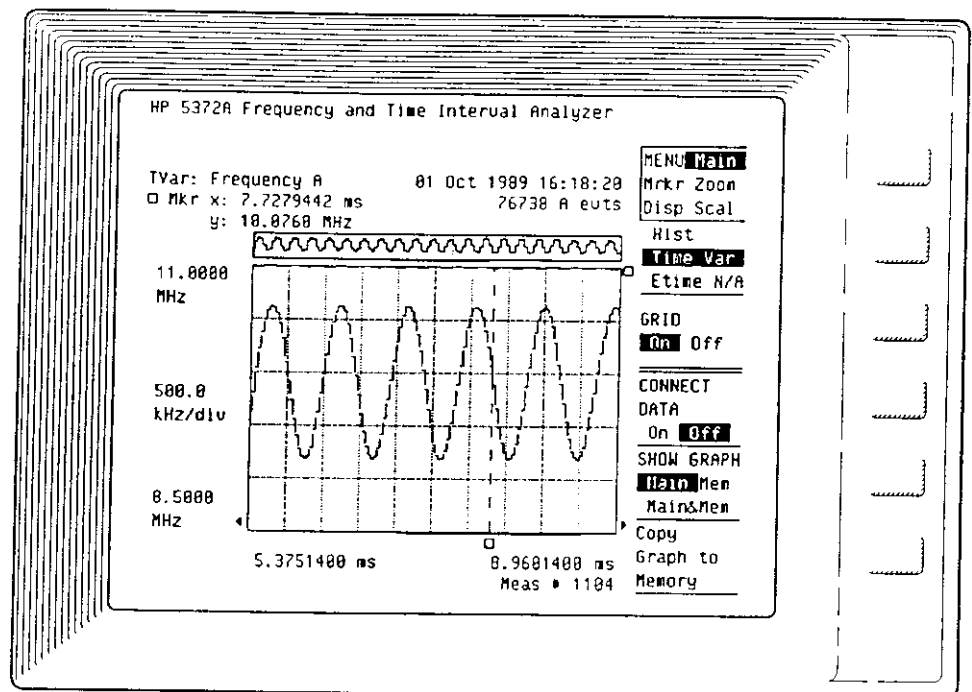

### CONNECT DATA:

- This feature provides a “connect-the-dots” display of the measurement data. No interpolation is done between data points. This is a linear connection of data points (see *Figure 16-15*).

Figure 16-15.  
Connect Data On

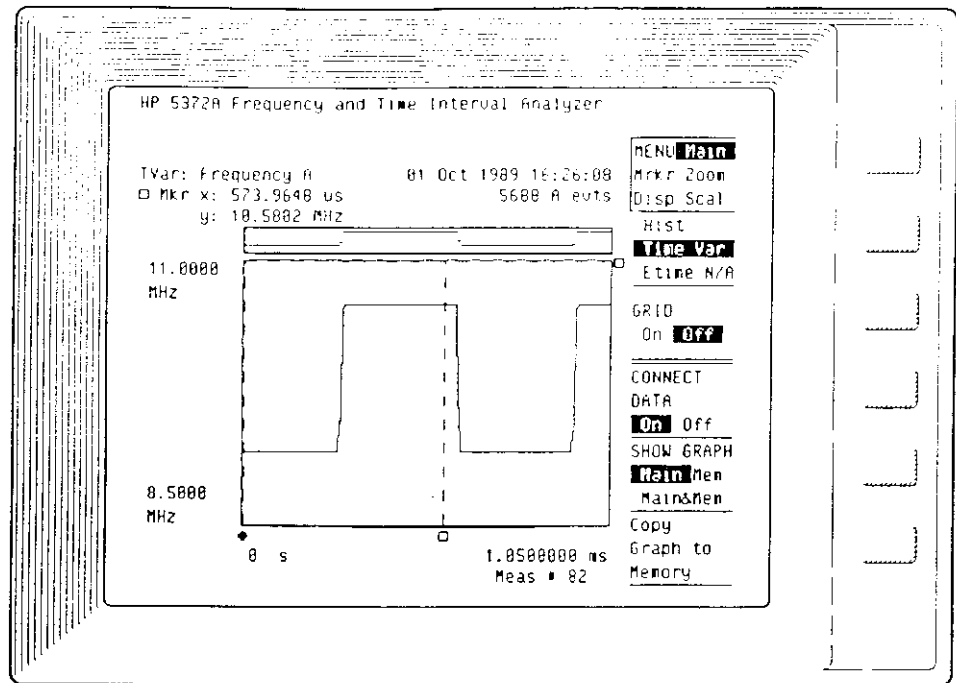

### Time Variation Marker Options

- Marker
- Delta
- Modulation Analysis
- Marker Next
- Marker to Maximum
- Marker to Minimum

#### MARKER:

- The  $\leftrightarrow \square \leftrightarrow \bullet$  markers provide an x-axis value of the time at which the measurement was acquired, and a y-axis value of the measurement result.
- The  $\updownarrow \square \updownarrow \bullet$  markers display a y-axis position, expressed in measurement units. The readout is related to the value at the marker's position on the y-axis scale, not the measurement data.

## DELTA:

- The delta information is presented for the portion of the graph data between the two markers.
- 'Delta x' for the  $\leftrightarrow \square \leftrightarrow \bullet$  markers is the difference between the stop times at which the two measurements were acquired.
- 'Delta y' for the  $\leftrightarrow \square \leftrightarrow \bullet$  markers is the difference in measurement values of the two measurements at the marker locations.
- Delta on the  $\leftrightarrow \square \leftrightarrow \bullet$  markers also provides a count of the input events between markers. This is only for the measurement configurations that provide this data to the graph (see Figure 16-16).
- Delta on the  $\uparrow \square \downarrow \bullet$  markers is the y-axis difference in the position of the two markers (see Figure 16-17).
- Status line displays the measurements that are the endpoints of the calculation.

Figure 16-16.  
Time Variation  
X-axis Delta

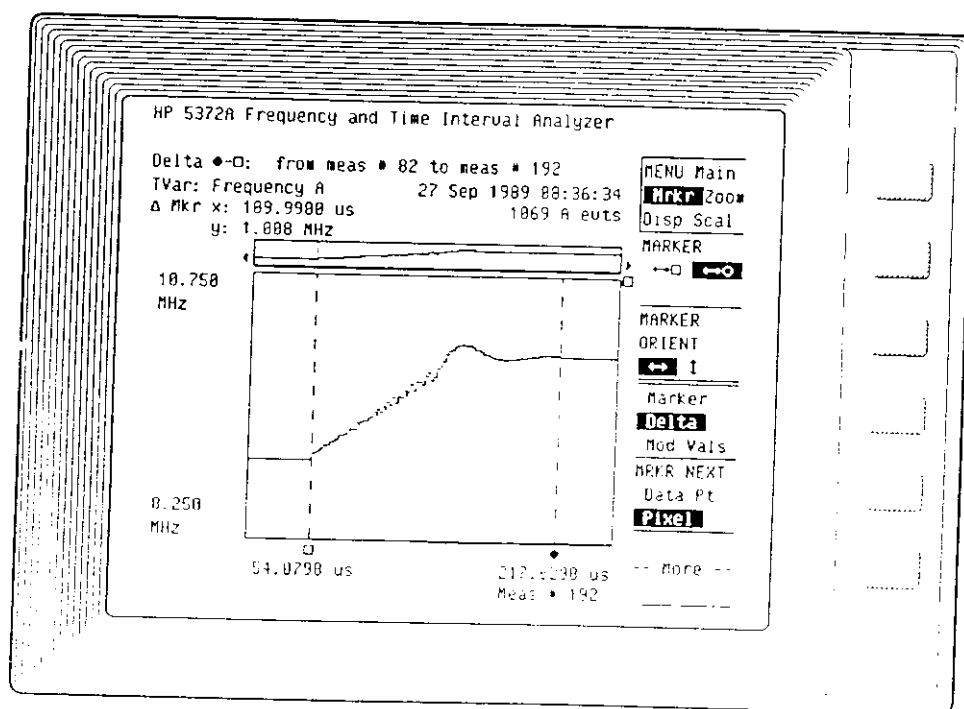
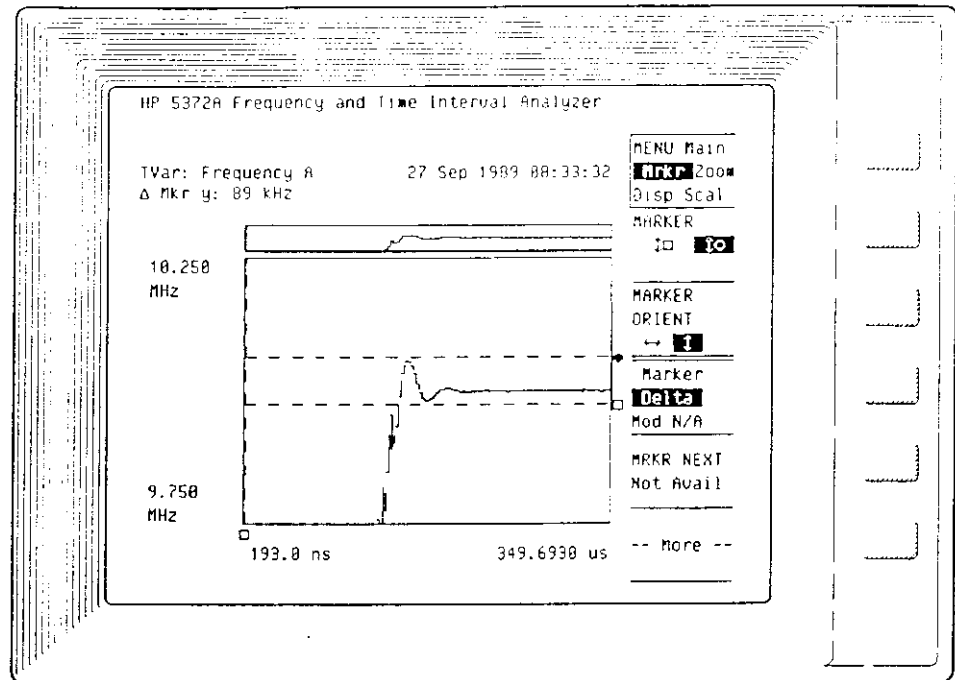

Figure 16-17.  
Time Variation  
Y-axis Delta



### NOTE

*Delta results are always calculated as the value of the active marker minus the value of the inactive marker. For example, if the x-axis position of the active marker is to the left of the inactive marker, the 'Delta x' value will always be negative.*

### MODULATION ANALYSIS:

The Modulation Analysis feature provides the following modulation parameters for the Time Variation graph data: the peak-to-peak deviation, the modulation center value, and the average modulation rate.

- The modulation values are re-computed whenever the markers are moved or another measurement acquisition takes place.

#### Comments:

- The words, "not computable," will be displayed where the modulation rate normally appears when:



1. The  $\leftrightarrow \square \leftrightarrow \bullet$  markers do not have at least one cycle of the modulating signal between them. The markers must encompass at least a pair of threshold crossings. A threshold is defined as 50% of the peak-to-peak deviation value.
2. The modulation on the portion of the signal bounded by the vertical markers does not exhibit periodic behavior.

Figure 16-18 shows an example of modulation analysis on a frequency modulated signal. Read the Technical Comment on the next page.

Figure 16-18.  
Modulation Analysis  
on a Sine Wave  
Modulated Signal

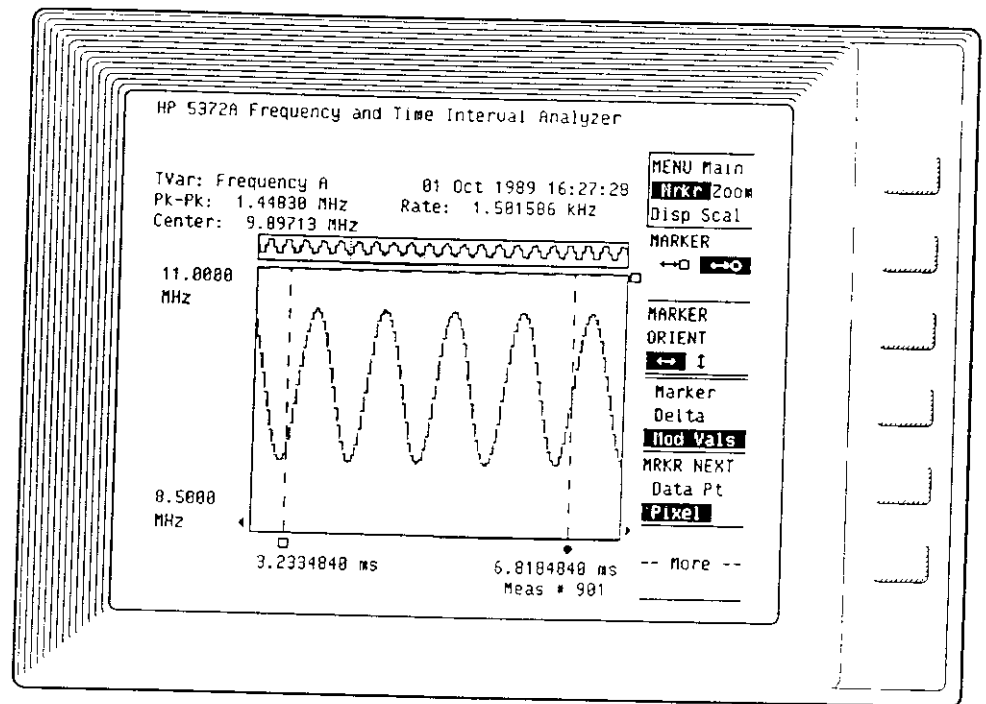



## TECHNICAL COMMENT

### *Modulation Analysis Calculations:*

*All calculations include only the portion of the measurement data enclosed by the markers.*

*Pk-Pk (Peak-to-Peak Deviation) — The Pk-Pk Deviation is the difference between the peak upper value and peak lower value.*

*Center (Center Value) — The Center value is calculated as the simple mean of the maximum and minimum y-axis values.*

*Rate (Average Modulation Rate) — Simply stated, the modulation rate is calculated as follows:*

$$\text{Modulation Rate} = \frac{\text{number of crossings of center value} - 1}{\text{time between first and last crossings}}$$

*The numerator is the number of modulation periods within the range of analysis. For both the first and last center crossings, the time of the crossing is estimated by first determining a third-order polynomial fit of the data near the crossing, then solving for the time at which the polynomial intersects the center value.*

*A hysteresis of 10% of the pk-pk deviation is used in the crossing count determination. This reduces the possibility of erroneous mis-counts due to noisy modulations or measurement data near the resolution limit of the HP 5372A.*

## MARKER NEXT:

- **Data Pt** — the active marker moves from measurement to measurement. When many measurements are combined into the 125 data columns, such as for a measurement size of 1,000 results or more, marker movement may appear sluggish because it is moving among multiple measurements within each column. As you zoom in on a graph, the display columns have fewer and fewer data points within them, until only one data point is shown per column, or no data points are contained in a column.
- **Pixel** — the active marker moves from display column to display column. This can be a faster way of scrolling through the data when the data is concentrated on the

display. If multiple measurements are included in a column, the marker will only indicate the first measurement to occur in each column. This is evident from watching the 'Meas #' readout just below the graph x-axis values as the marker is scrolled across the display.

#### MOVE MARKER TO MAXIMUM:

- The active marker moves to the maximum data point on the portion of the graph currently displayed.

#### MOVE MARKER TO MINIMUM:

- The active marker moves to the minimum data point on the portion of the graph currently displayed.

### Time Variation Zoom Options

- Zoom In
- Zoom Out

#### ZOOM IN:

- Pressing this softkey magnifies a portion of the graph, giving a close-up view of the data. The zoom action takes place around the active marker.
- The panorama display above the main display area always shows all the data that is available for viewing. There is a highlighted line segment under the panorama display that indicates the portion of the whole graph that is currently shown in the main display area.
- Use the **Return to Full Scale** softkey at any time to display all the measurement data that has been graphed.

**ZOOM OUT:**

- The **Zoom Out** softkey performs the reverse of the **Zoom In** softkey. Approximately twice as much of the graph will be displayed each time the **Zoom Out** softkey is pressed.

**Comments:**

You can zoom in on data of interest between two markers with a feature in the **Scaling Options**. Use the following steps:

1. Set markers to enclose data of interest.
2. Go to **Scaling Options** and press **Marker Range Hold X-axis** softkey.
3. Set **Manual Scale** to **On**.

**Time Variation  
Display Options**

- **Update**
- **View Channel**

**UPDATE:**

The **Update** feature is available for the **Time Variation** graph when measurement sequences are multi-block AND the total number of measurements exceeds measurement memory. This is indicated by text on the **Function** menu that reads as follows:

1. "Results will be most recently acquired block"

OR

2. "Display Averaged Results from all blocks," with the "Averaged Results" field locked-out, that is, it is not selectable with the menu cursor.

*Figure 16-19* shows a setup where **UPDATE** is not offered. *Figure 16-20* shows a setup where **UPDATE While or After** is available.

Figure 16-19.  
UPDATE is Not Available

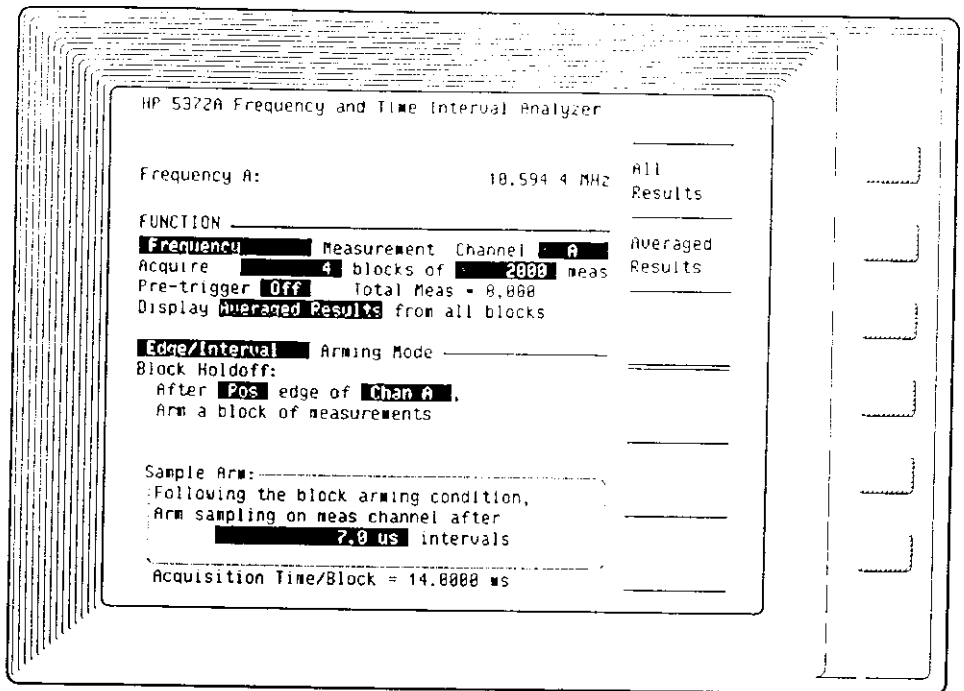
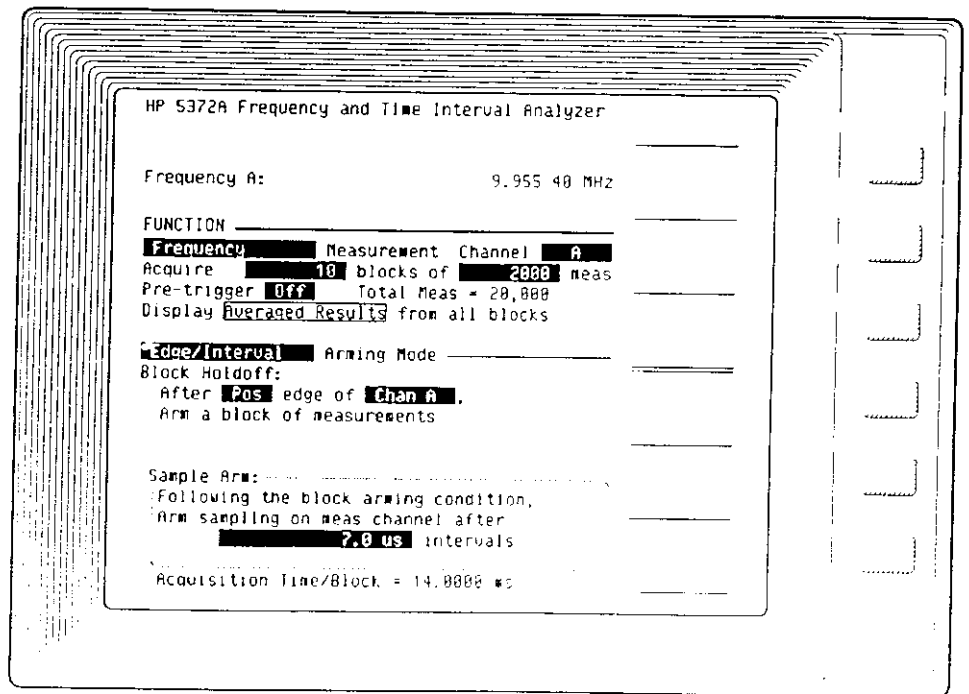

Figure 16-20.  
UPDATE While or After  
Selection is Available



- **UPDATE While** — the Time Variation graph is updated after each block to reflect the cumulative data. It is useful for observing trends after only a few blocks to help determine if the measurement is appropriate.
- **UPDATE After** — the Time Variation graph is not displayed until all blocks of data have been collected. This is a faster mode of operation for multiple-block measurements because the graph is only drawn once. The disadvantage is that no results are observable until the end of the measurement sequence. For a large number of blocks, this could take quite some time. During the acquisition, the current number of blocks collected is displayed on the Numeric screen.

#### **VIEW CHANNEL:**

- For dual-channel, dual-result measurements, such as Frequency or Period A&B, or Totalize A&B, you can select one or the other channel to graph.

### **Time Variation Scaling Options**

- **Manual Scaling**

For a description of each of the Scaling Options softkeys, see “Scaling Options” in this chapter.

#### **AUTOSCALING:**

- The x-axis values are determined by the time range delimited by the first and last measurements of the measurement sequence. The graph will fit within that range.
- The y-axis values are determined by the minimum and maximum measurement data values. The minimum and maximum y-axis values of the graph will be adjusted to values that enclose the actual measured values.

#### **MANUAL SCALING:**

- For the x-axis, the user may enter a minimum and maximum value. Note that the x-axis is only in terms of actual measurement time. Therefore, the minimum and maximum values must both be greater than, or equal to, zero. If a negative number is entered, it will default to zero.

- For the y-axis, the user may enter a minimum and maximum value. There are no limitations on negative values. If Math features are enabled, it is possible that measurement results will be negative. Also, negative results are possible for  $\pm$  TI, Phase Deviation, Time Deviation, and Difference measurement results for Frequency, Period, and Totalize.

## BLOCK AVERAGING AND TIME VARIATION GRAPH

The HP 5372A has the capability of averaging multiple blocks of measurements. This is valuable for increasing the resolution of measurement sequences that have dynamic, repeating inputs. It is made possible by the ability of the HP 5372A to reference in time the different blocks of measurements. This is done by measuring the time from the event that arms a block of measurements to the first sample of that block. Review chapter 2, "Frequency/Period Measurements" and chapter 5, "Arming," for a description of blocks of measurements, samples, and arming terms. **IT IS IMPORTANT TO REALIZE THAT WHEN BLOCK AVERAGING IS ACTIVE, THE INDIVIDUAL BLOCK RESULTS ARE UNAVAILABLE.**

The measurement configurations that reference the block of measurements to the block arming edge are listed below. This time reference is critical to the ability to "time-relate" multiple acquisitions of a repetitive modulated signal. The arming edge for the block must have a fixed relationship to the modulation on the input (an alignment of modulation vs. time). An example of this is: the reference edge is the voltage tuning step from a VCO and the measured signal is the VCO output.

The approach for averaging multiple blocks of measurements is: using the block arming edge as the time reference for each block that is acquired, the blocks are averaged together in both the x-axis (time) and y-axis (measured value) dimensions.

The averaging feature is selected on the Function menu. It is available for a specific set of measurement functions and arming modes. These setups reference the block of measurements to the block arming edge rather than the first sample of the block. This is necessary to properly time-relate multiple acquisitions of a repetitive input signal.

## Measurements That Provide Averaged Results

Block Averaging is provided for the following measurement configurations:

- A Frequency or Period measurement sequence of multiple blocks with one of the following arming modes:
  - Edge Holdoff
  - Time Holdoff
  - Event Holdoff
  - Edge / Interval
  - Edge / Edge
  - Edge / Cycle
  - Time / Interval
  - Event / Interval
  
- A Continuous Time Interval measurement sequence of multiple blocks with one of the following arming modes:
  - Edge Holdoff
  - Time Holdoff
  - Event Holdoff
  - Edge / Interval
  
- A Phase or Phase Deviation measurement sequence of multiple blocks with one of the following arming modes:
  - Edge Holdoff
  - Edge Interval

If the total number of measurements in the acquisition exceeds the measurement memory, the Time Variation graph can be redrawn after each block. The feature that allows this selection is UPDATE on the Display Options menu. For measurement sequences exceeding the measurement memory size, the Numeric screen always displays a block of averaged results after each additional block is acquired. Each Time Variation graph display shows the average of the blocks accumulated up to that point. The final graph shows the averaged results of all the blocks. (See description of UPDATE under "Time Variation Display Options".)



## Timing Information

The time reference at the beginning of each block is called a "time-stamp" of the block arming edge. The time value is labeled with a letter "T" on the Numeric screen results before the first measurement of a block. A "T" appears on the Time Variation graph only when "All Results" is selected on the Function menu in place of "Averaged Results." (The choice of "All Results" is only available for block averaged acquisitions when the total number of measurements [blocks  $\times$  measurements per block] will fit in measurement memory.) *Figure 16-21* shows an example of a Time Variation graph with multiple time referenced blocks. Also, if the marker is on the time-stamp, the x-axis time will be displayed, the y-axis shows "(holdoff edge)", and the measurement number = "T".

*Figure 16-21.*  
All Results Selected for  
Measurement Results

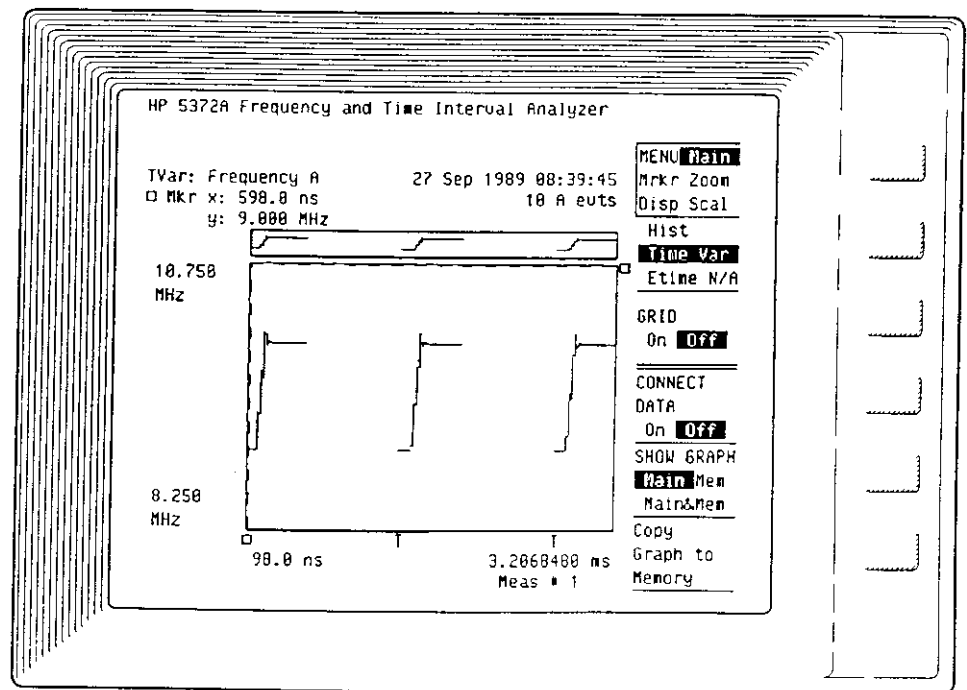

**NUMERIC SCREEN TIMING**

The time from the block arming edge to the first sample of the measurement block is displayed on the Numeric screen preceded by the letter "T" (see Figure 16-22).

Figure 16-22.  
T = Time from Block Arming Edge to First Sample

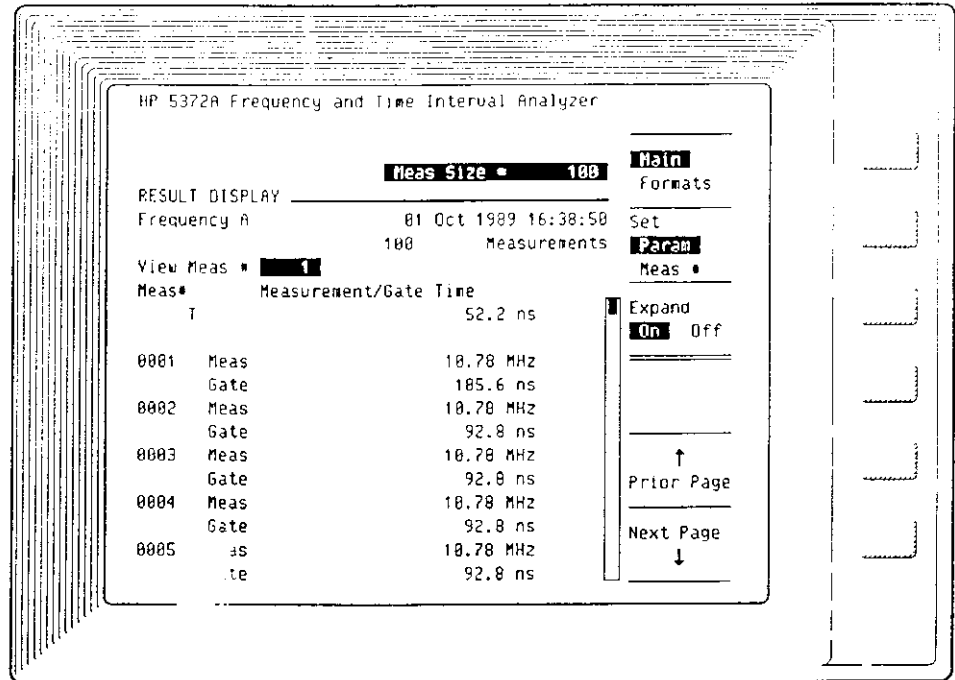

**TIME VARIATION GRAPH TIMING**

The averaged data points on the Time Variation graph are positioned at the center of their measurement intervals. The time value (x-axis) of the first measurement of the block is (the time from the block arming edge to the first sample of the measurement block) PLUS (half the measurement interval of the first measurement). The x-axis time to the subsequent measurements is always the time from the block holdoff edge to the middle of the measurement interval located by the active marker. Compare the x-axis marker information of the first measurement in Figure 16-23 to the time of the "T" value plus half the gate time of the first measurement in Figure 16-22.

Figure 16-19.  
UPDATE is Not Available

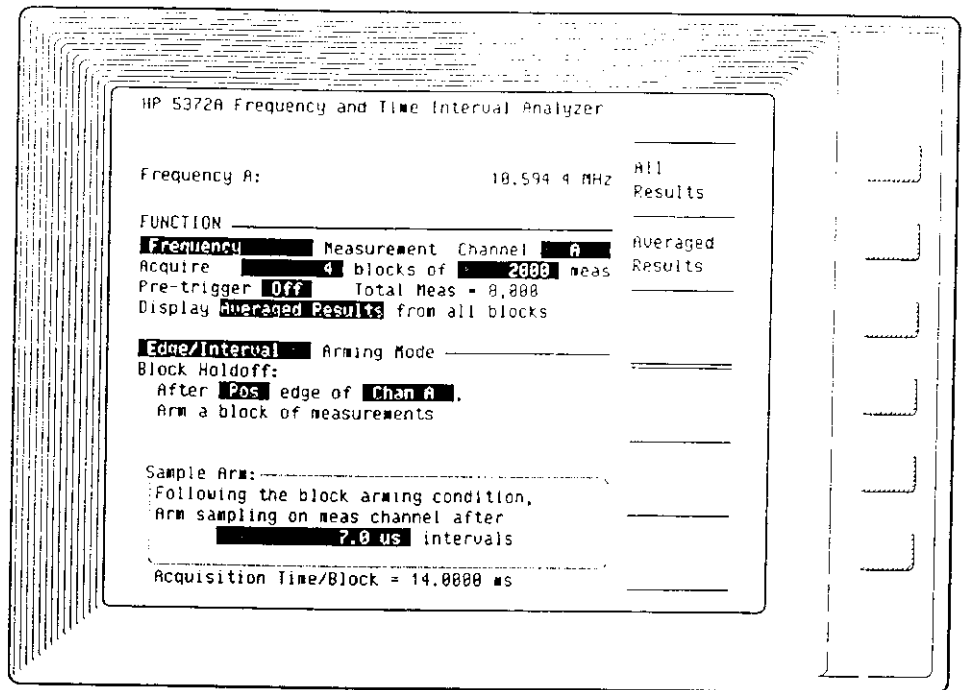
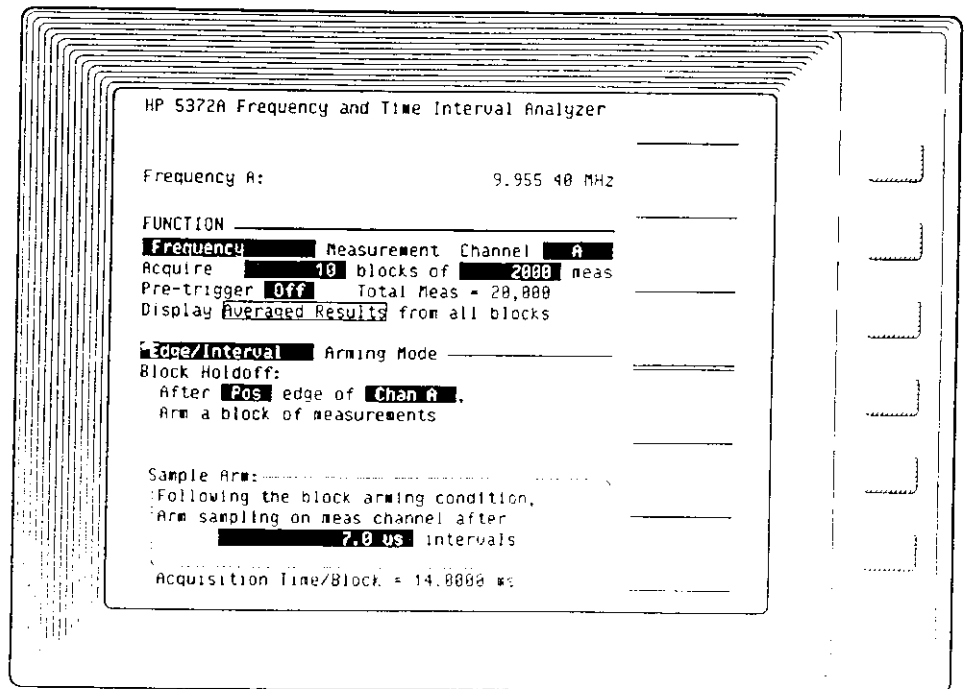

Figure 16-20.  
UPDATE While or After  
Selection is Available



- **UPDATE While** — the Time Variation graph is updated after each block to reflect the cumulative data. It is useful for observing trends after only a few blocks to help determine if the measurement is appropriate.
- **UPDATE After** — the Time Variation graph is not displayed until all blocks of data have been collected. This is a faster mode of operation for multiple-block measurements because the graph is only drawn once. The disadvantage is that no results are observable until the end of the measurement sequence. For a large number of blocks, this could take quite some time. During the acquisition, the current number of blocks collected is displayed on the Numeric screen.

#### **VIEW CHANNEL:**

- For dual-channel, dual-result measurements, such as Frequency or Period A&B, or Totalize A&B, you can select one or the other channel to graph.

### **Time Variation Scaling Options**

- **Manual Scaling**

For a description of each of the Scaling Options softkeys, see “Scaling Options” in this chapter.

#### **AUTOSCALING:**

- The x-axis values are determined by the time range delimited by the first and last measurements of the measurement sequence. The graph will fit within that range.
- The y-axis values are determined by the minimum and maximum measurement data values. The minimum and maximum y-axis values of the graph will be adjusted to values that enclose the actual measured values.

#### **MANUAL SCALING:**

- For the x-axis, the user may enter a minimum and maximum value. Note that the x-axis is only in terms of actual measurement time. Therefore, the minimum and maximum values must both be greater than, or equal to, zero. If a negative number is entered, it will default to zero.

- For the y-axis, the user may enter a minimum and maximum value. There are no limitations on negative values. If Math features are enabled, it is possible that measurement results will be negative. Also, negative results are possible for  $\pm$  TI, Phase Deviation, Time Deviation, and Difference measurement results for Frequency, Period, and Totalize.

## BLOCK AVERAGING AND TIME VARIATION GRAPH

The HP 5372A has the capability of averaging multiple blocks of measurements. This is valuable for increasing the resolution of measurement sequences that have dynamic, repeating inputs. It is made possible by the ability of the HP 5372A to reference in time the different blocks of measurements. This is done by measuring the time from the event that arms a block of measurements to the first sample of that block. Review chapter 2, "Frequency/Period Measurements" and chapter 5, "Arming," for a description of blocks of measurements, samples, and arming terms. **IT IS IMPORTANT TO REALIZE THAT WHEN BLOCK AVERAGING IS ACTIVE, THE INDIVIDUAL BLOCK RESULTS ARE UNAVAILABLE.**

The measurement configurations that reference the block of measurements to the block arming edge are listed below. This time reference is critical to the ability to "time-relate" multiple acquisitions of a repetitive modulated signal. The arming edge for the block must have a fixed relationship to the modulation on the input (an alignment of modulation vs. time). An example of this is: the reference edge is the voltage tuning step from a VCO and the measured signal is the VCO output.

The approach for averaging multiple blocks of measurements is: using the block arming edge as the time reference for each block that is acquired, the blocks are averaged together in both the x-axis (time) and y-axis (measured value) dimensions.

The averaging feature is selected on the Function menu. It is available for a specific set of measurement functions and arming modes. These setups reference the block of measurements to the block arming edge rather than the first sample of the block. This is necessary to properly time-relate multiple acquisitions of a repetitive input signal.

## Measurements That Provide Averaged Results

Block Averaging is provided for the following measurement configurations:

- A Frequency or Period measurement sequence of multiple blocks with one of the following arming modes:
  - Edge Holdoff
  - Time Holdoff
  - Event Holdoff
  - Edge / Interval
  - Edge / Edge
  - Edge / Cycle
  - Time / Interval
  - Event / Interval
  
- A Continuous Time Interval measurement sequence of multiple blocks with one of the following arming modes:
  - Edge Holdoff
  - Time Holdoff
  - Event Holdoff
  - Edge / Interval
  
- A Phase or Phase Deviation measurement sequence of multiple blocks with one of the following arming modes:
  - Edge Holdoff
  - Edge Interval

If the total number of measurements in the acquisition exceeds the measurement memory, the Time Variation graph can be redrawn after each block. The feature that allows this selection is UPDATE on the Display Options menu. For measurement sequences exceeding the measurement memory size, the Numeric screen always displays a block of averaged results after each additional block is acquired. Each Time Variation graph display shows the average of the blocks accumulated up to that point. The final graph shows the averaged results of all the blocks. (See description of UPDATE under "Time Variation Display Options".)

## Timing Information

The time reference at the beginning of each block is called a "time-stamp" of the block arming edge. The time value is labeled with a letter "T" on the Numeric screen results before the first measurement of a block. A "T" appears on the Time Variation graph only when "All Results" is selected on the Function menu in place of "Averaged Results." (The choice of "All Results" is only available for block averaged acquisitions when the total number of measurements [blocks  $\times$  measurements per block] will fit in measurement memory.) Figure 16-21 shows an example of a Time Variation graph with multiple time referenced blocks. Also, if the marker is on the time-stamp, the x-axis time will be displayed, the y-axis shows "(holdoff edge)", and the measurement number = "T".

Figure 16-21.  
All Results Selected for  
Measurement Results

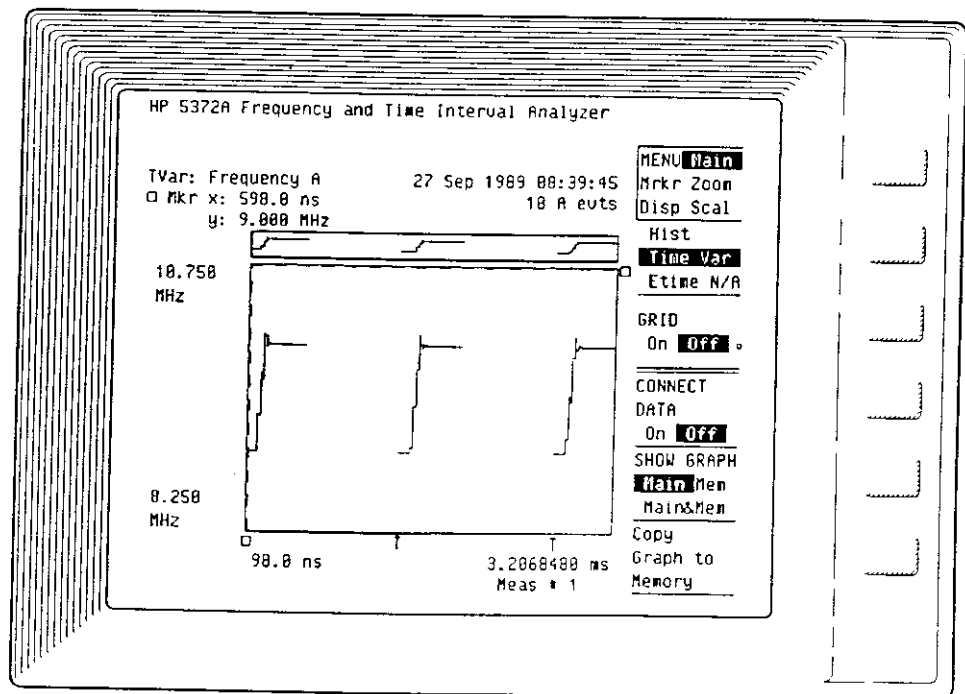

**NUMERIC SCREEN TIMING**

The time from the block arming edge to the first sample of the measurement block is displayed on the Numeric screen preceded by the letter "T" (see Figure 16-22).

Figure 16-22.  
T = Time from Block Arming Edge to First Sample

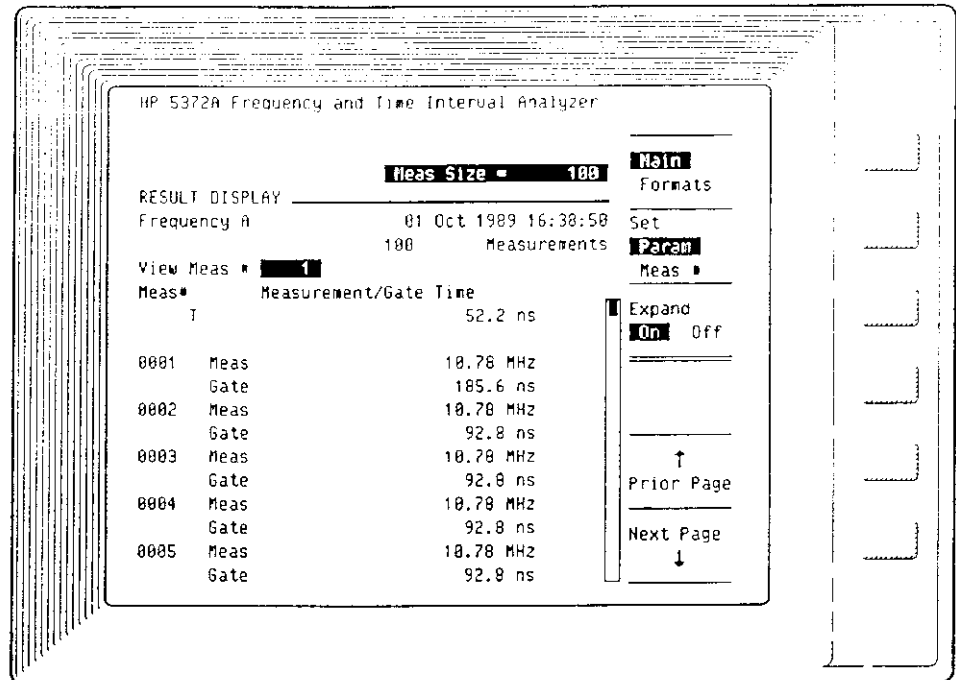

**TIME VARIATION GRAPH TIMING**

The averaged data points on the Time Variation graph are positioned at the center of their measurement intervals. The time value (x-axis) of the first measurement of the block is (the time from the block arming edge to the first sample of the measurement block) PLUS (half the measurement interval of the first measurement). The x-axis time to the subsequent measurements is always the time from the block holdoff edge to the middle of the measurement interval located by the active marker. Compare the x-axis marker information of the first measurement in Figure 16-23 to the time of the "T" value plus half the gate time of the first measurement in Figure 16-22.



Figure 16-23.  
Data Points are Located at  
the Center of Their  
Measurement Intervals

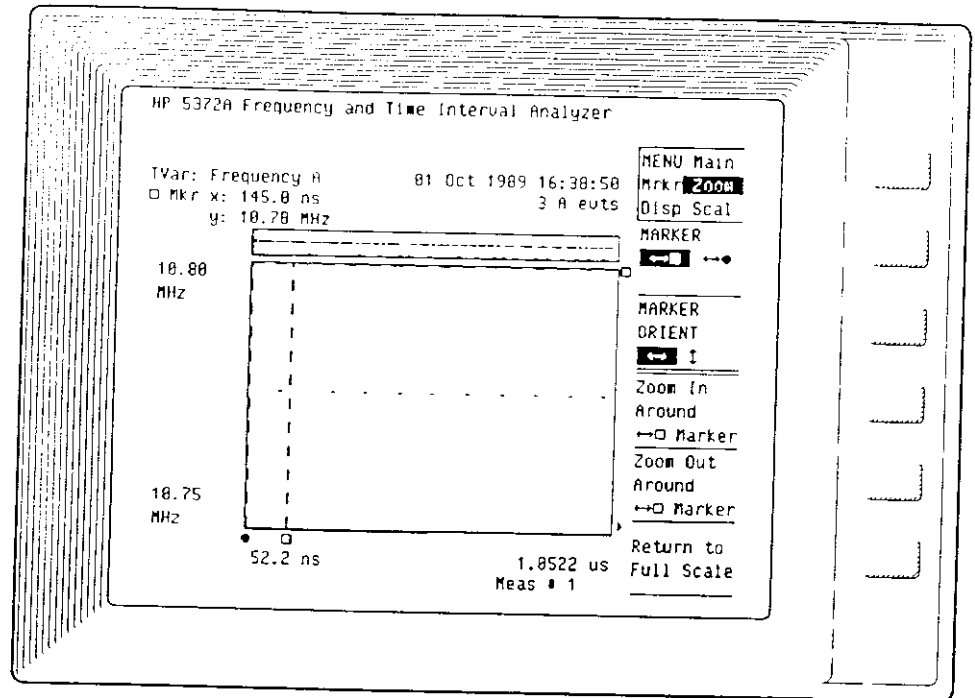

### Limit Lines on Time Variation

Limit lines on Time Variation graphs are two horizontal lines which overlay the graph. Their positions are dictated by the limit values entered on the Math menu. One line marks the low limit, and one marks the high limit. Limit lines are displayed when:

- the Limits feature is enabled on the Math menu for the channel being measured,
- the limit values are within the display range of the graph being viewed.

#### Comments:

If one or both limit lines fail to appear on the graph, check the graph scale to make sure the limit values are within those spanned by the graph.

## PRE-TRIGGER AND TIME VARIATION

When a measurement sequence uses Pre-trigger, the measurement where the pre-trigger event occurred is identified with a "P" on the x-axis (see *Figure 16-24*). For information on how to use Pre-trigger, see chapter 10, "Pre-trigger Menu."

*Figure 16-24.*  
Pre-trigger on the Time Variation graph

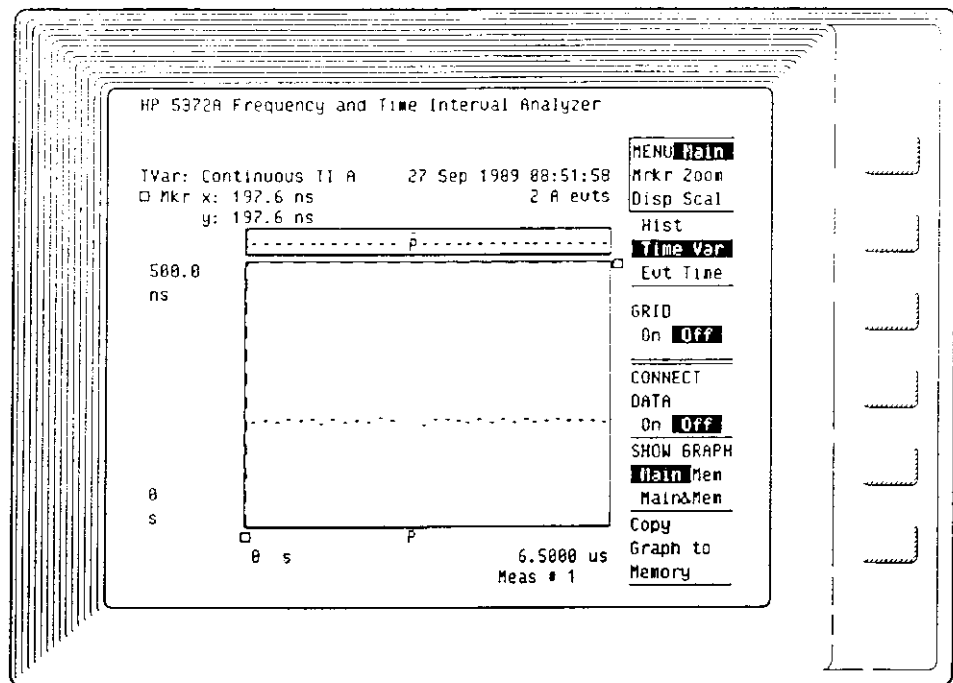

## MEASUREMENT INHIBIT ON TIME VARIATION

The Inhibit feature is used to selectively suppress the storage of measurement data. It is enabled on the Pre-trigger menu. The Inhibit signal polarity and voltage threshold are specified on the Pre-trigger menu. When the Inhibit feature is active, measurement data is not stored in measurement memory. Any input signal activity during Inhibit is not included in the measurement acquisition. The Time Variation graph shows an "I" to indicate measurements preceded or extended by Inhibit. Also, measurement number will have an "I" appended. Any measurements extended by Inhibit are not included in statistical or limit analysis. *Figure 16-25* shows a measurement sequence interrupted by Inhibit. For more on Inhibit, see chapter 10, "Pre-trigger Menu."

Figure 16-25.  
Measurement Inhibit on  
Time Variation Graph

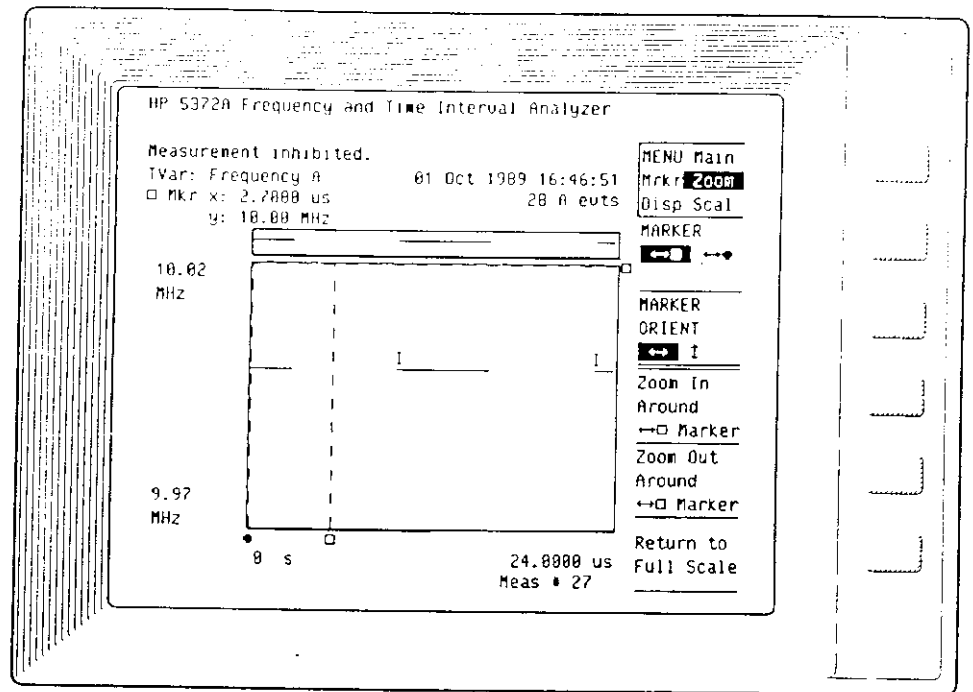

## EVENT TIMING GRAPH

The Event Timing graph plots the measurement start and stop values versus the actual time of the measurements. This graph is only available for time interval measurements (not Frequency, Period, or Totalize). The x-axis covers the time span over which the measurements were acquired. There is no y-axis for this graph; it is one-dimensional.

The graph is drawn as a single horizontal line, with short vertical lines (called ticks) above the horizontal line representing start measurement values, and the ticks below the horizontal line representing stop measurement values. For a given data point, the x-axis value is the actual start or stop time of the measurement relative to the first measurement in the sequence. For any x-axis value, there may be no ticks, a start tick, a stop tick, or both a start and a stop tick. Time-stamps, inhibits, and pre-trigger all appear on the Event Timing graph in the same way as for the Time Variation graph (T, I, P).

Figure 16-26 shows an Event Timing graph with information on the organization of the graph.

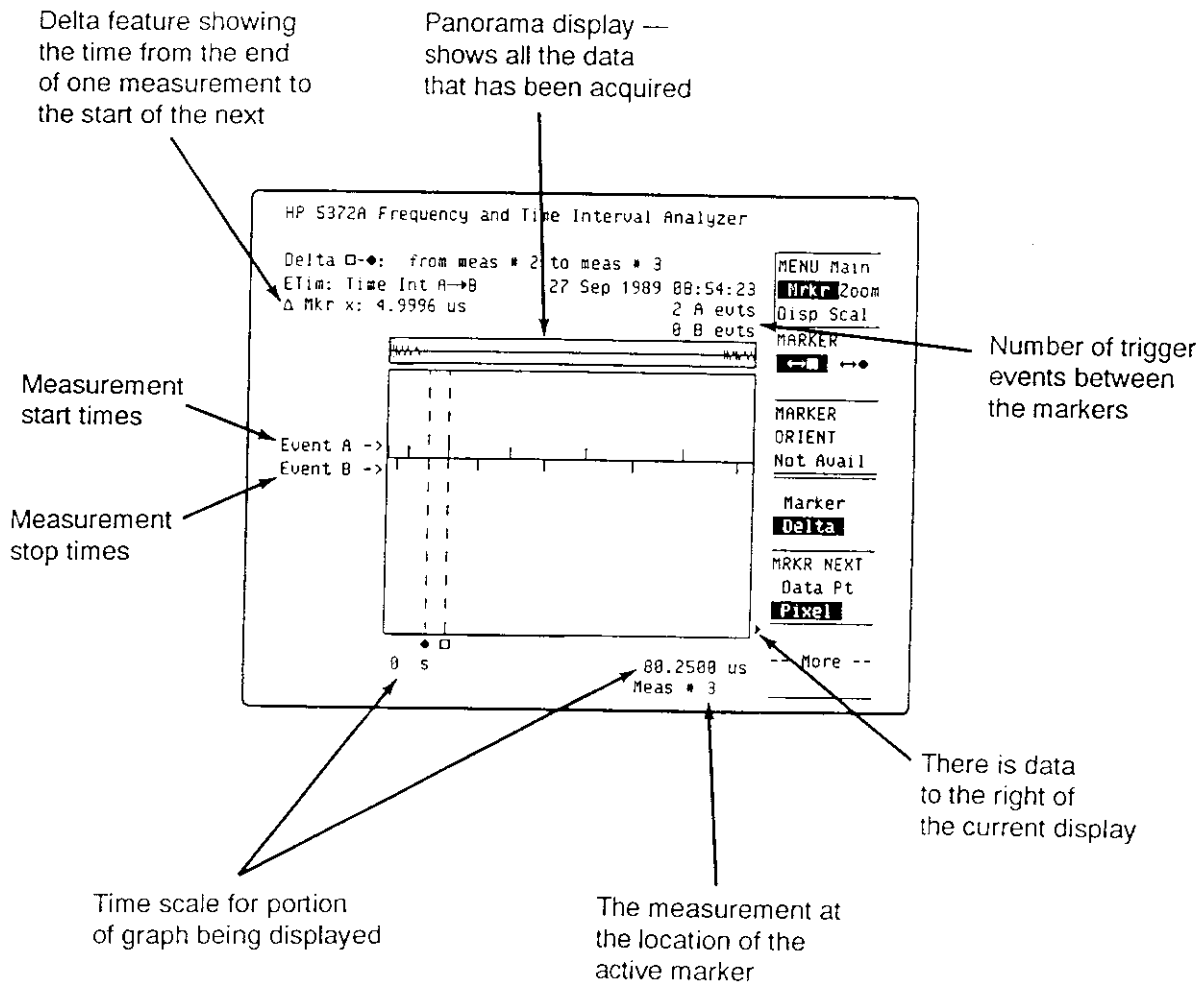

Figure 16-26. Event Timing Graph Organization

## Event Timing Display Options

There are no display options available for Event Timing graphs.

## Event Timing Scaling Options

- Manual Scaling

### AUTOSCALING:

- The x-axis values are determined by the time range delimited by the first and last measurements. The graph will fit within that range on the x-axis.

### MANUAL SCALING:

- For the x-axis, the user may enter a minimum and maximum value. Note that the x-axis is only in terms of actual measurement time. Therefore, the minimum and maximum values must both be greater than, or equal to, zero. If a negative number is entered, it will default to 0.

## PRESET VALUES

The following graphics conditions are set with the Preset key:

### ALL GRAPHS:

- Displayed graph = Histogram
- X- and Y-axis Manual Scaling Off
- Active Marker = ↔ □
- Marker Display Mode = Marker
- GRID Off
- MARKER NEXT = Pixel
- SHOW GRAPH = Main
- Memory Graph cleared

### HISTOGRAM:

- OUTLINE = On
- UPDATE = While
- YSCALE = Linear
- VIEW CHANNEL = A

### TIME VARIATION:

- CONNECT DATA Off
- VIEW CHANNEL = A

## **SAVED PARAMETERS**

The following parameters are stored when the instrument configuration is saved, or when the instrument is switched off:

- Graph type selected (Histogram or Time Variation or Event Timing)
- X- and Y-axis Manual Scaling status
- All Manual Scaling values
- Active marker and its orientation
- Marker Display Mode
- Grid status
- Marker locations
- Yscale mode
- Update mode
- Connect Data mode
- View Channel mode for Histogram and Time Variation

The following values are not saved:

- Memory Graph data
- Main Graph data
- Marker, delta, statistics, and modulation values from the graph data
- Event counts from the graph data
- Measurement number from the graph data
- Histogram underflow/overflow from the graph data
- Axes endpoints from the graph data

## Event Timing Main Options

- Grid

### GRID:

- The graph is divided by nine vertical lines. The spacing of the lines is not referenced to the displayed measurement results.

## Event Timing Marker Options

- Marker
- Delta
- Marker Next

### MARKER:

- Only  $\leftrightarrow\square\leftrightarrow\bullet$  markers are available.
- The  $\leftrightarrow\square\leftrightarrow\bullet$  markers provide an x-axis value that is the start or stop time of a measurement.

### DELTA:

- Delta is the difference in time of the current marker positions.

### MARKER NEXT:

- Data Pt — the active marker moves from measurement to measurement. When many measurements are combined into the 125 data columns, such as for a measurement size of 1,000 results or more, marker movement may appear sluggish because it is moving among multiple measurements within each column. As you zoom in on a graph, the display columns have fewer and fewer data points within them, until only one data point is shown per column, or no data points are contained in a column.
- Pixel — the active marker moves from display column to display column. This can be a faster way of scrolling through the data when the data is concentrated on the display. If multiple measurements are included in a column, the marker will only indicate the first measurement to occur in each column. This is evident from watching the 'Meas #' readout just below the graph x-axis values as the marker is scrolled across the display.

## Event Timing Zoom Options

- Zoom In
- Zoom Out

### ZOOM IN:

- There are 125 display columns across the graph area. When the number of measurements is such that they cannot all be assigned to individual display columns, only one measurement will be graphed per column. The graph must be zoomed in to resolve the overlapped data points into individual display columns.
- Pressing this softkey magnifies a portion of the graph, giving a close-up view of the data. The zoom action takes place around the active marker.
- The panorama display above the main display area always shows all the data that is available for viewing. There is a highlighted line segment under the panorama display that indicates the portion of the whole graph that is currently shown in the main display area.
- Use the **Return to Full Scale** softkey at any time to display all the measurement data that has been graphed.

### ZOOM OUT:

- The **Zoom Out** softkey performs the reverse of the **Zoom In** softkey. Approximately twice as much of the graph will be displayed each time the **Zoom Out** softkey is pressed.

### Comments:

You can zoom in on data of interest between two markers with a feature in the Scaling Options. Use the following steps:

1. Set markers to enclose data of interest.
2. Go to Scaling Options and press **Marker Range Hold X-axis** softkey.
3. Set Manual Scale to On.



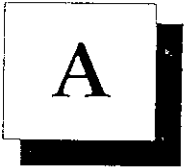

# Contents of Appendix

---

Introduction ..... A-1  
Overview of Menu Maps ..... A-1

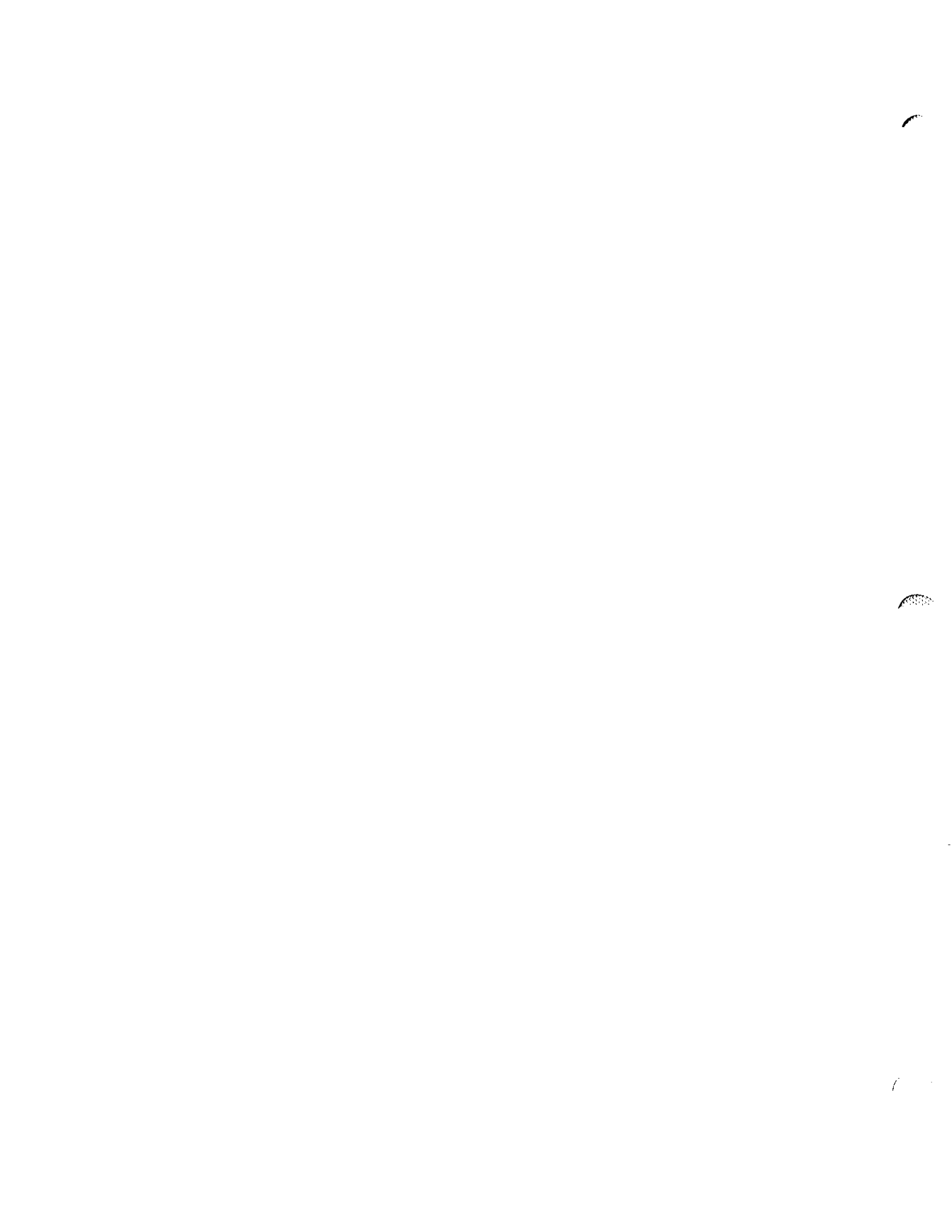

# A GUIDE TO THE FUNCTION MENU

---

## INTRODUCTION

Use this series of three menu maps to help understand the effects of the arming mode and the measurement size on the type of results that are available from the HP 5372A. These menu maps should be used as a guide. They are limited to showing single-channel measurements for the major measurement functions. The principles documented can be applied to the other measurement functions, once you understand the characteristics of those functions.

The following chapters of the Operating Manual should be used as reference material for this guide:

- Chapter 1, Time Interval Measurements
- Chapter 2, Frequency/Period Measurements
- Chapter 7, Function Menu
- Chapter 10, Pre-trigger Menu

## OVERVIEW OF MENU MAPS

The flowchart on the next page directs you to one of the menu maps depending on the size of the measurement and the kind of results you want. The purpose of each map is described briefly here:

- Menu Map A — This menu helps you to select the maximum number of measurements per block for a single-block measurement. All results are available for numeric and graphic analysis.
- Menu Map B — This menu helps you to select the maximum number of measurements per block for a multiple-block measurement so that all results are available for numeric and graphic analysis. It also shows the arming modes that provide averaging of results.

- Menu Map C — This menu covers the situations where measurement memory could be exceeded as a result of the multiple-block measurement size. When all the measurements will not fit in memory, not all results are available for review. There are times when this is preferable to using smaller measurement sizes. Some advantages are:
  - All the measurement values are included in statistics.
  - All the measurement values are included in limit testing.
  - All measurement values are included in Histogram graphs.
  - When averaging, the final block of measurements includes all the measurement values from each of the blocks.
  - Pre-trigger on multiple blocks provides the advantage of repeated execution of the block holdoff condition while waiting for the pre-trigger event. This sets a reference for each block of measurement data.

- For the y-axis, the user may enter a minimum and maximum value. There are no limitations on negative values. If Math features are enabled, it is possible that measurement results will be negative. Also, negative results are possible for  $\pm$  TI, Phase Deviation, Time Deviation, and Difference measurement results for Frequency, Period, and Totalize.

## BLOCK AVERAGING AND TIME VARIATION GRAPH

The HP 5372A has the capability of averaging multiple blocks of measurements. This is valuable for increasing the resolution of measurement sequences that have dynamic, repeating inputs. It is made possible by the ability of the HP 5372A to reference in time the different blocks of measurements. This is done by measuring the time from the event that arms a block of measurements to the first sample of that block. Review chapter 2, "Frequency/Period Measurements" and chapter 5, "Arming," for a description of blocks of measurements, samples, and arming terms. **IT IS IMPORTANT TO REALIZE THAT WHEN BLOCK AVERAGING IS ACTIVE, THE INDIVIDUAL BLOCK RESULTS ARE UNAVAILABLE.**

The measurement configurations that reference the block of measurements to the block arming edge are listed below. This time reference is critical to the ability to "time-relate" multiple acquisitions of a repetitive modulated signal. The arming edge for the block must have a fixed relationship to the modulation on the input (an alignment of modulation vs. time). An example of this is: the reference edge is the voltage tuning step from a VCO and the measured signal is the VCO output.

The approach for averaging multiple blocks of measurements is: using the block arming edge as the time reference for each block that is acquired, the blocks are averaged together in both the x-axis (time) and y-axis (measured value) dimensions.

The averaging feature is selected on the Function menu. It is available for a specific set of measurement functions and arming modes. These setups reference the block of measurements to the block arming edge rather than the first sample of the block. This is necessary to properly time-relate multiple acquisitions of a repetitive input signal.

## Measurements That Provide Averaged Results

Block Averaging is provided for the following measurement configurations:

- A Frequency or Period measurement sequence of multiple blocks with one of the following arming modes:
  - Edge Holdoff
  - Time Holdoff
  - Event Holdoff
  - Edge / Interval
  - Edge / Edge
  - Edge / Cycle
  - Time / Interval
  - Event / Interval
  
- A Continuous Time Interval measurement sequence of multiple blocks with one of the following arming modes:
  - Edge Holdoff
  - Time Holdoff
  - Event Holdoff
  - Edge / Interval
  
- A Phase or Phase Deviation measurement sequence of multiple blocks with one of the following arming modes:
  - Edge Holdoff
  - Edge Interval

If the total number of measurements in the acquisition exceeds the measurement memory, the Time Variation graph can be redrawn after each block. The feature that allows this selection is UPDATE on the Display Options menu. For measurement sequences exceeding the measurement memory size, the Numeric screen always displays a block of averaged results after each additional block is acquired. Each Time Variation graph display shows the average of the blocks accumulated up to that point. The final graph shows the averaged results of all the blocks. (See description of UPDATE under "Time Variation Display Options".)

## Timing Information

The time reference at the beginning of each block is called a "time-stamp" of the block arming edge. The time value is labeled with a letter "T" on the Numeric screen results before the first measurement of a block. A "T" appears on the Time Variation graph only when "All Results" is selected on the Function menu in place of "Averaged Results." (The choice of "All Results" is only available for block averaged acquisitions when the total number of measurements [blocks × measurements per block] will fit in measurement memory.) *Figure 16-21* shows an example of a Time Variation graph with multiple time referenced blocks. Also, if the marker is on the time-stamp, the x-axis time will be displayed, the y-axis shows "(holdoff edge)", and the measurement number = "T".

*Figure 16-21.*  
All Results Selected for  
Measurement Results

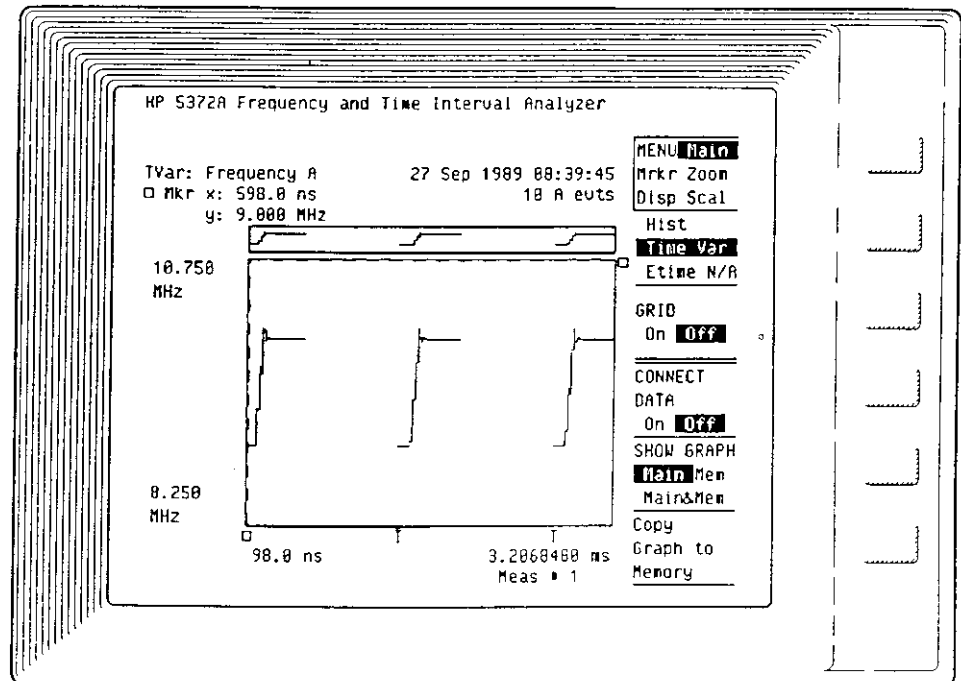

**NUMERIC SCREEN TIMING** The time from the block arming edge to the first sample of the measurement block is displayed on the Numeric screen preceded by the letter "T" (see Figure 16-22).

Figure 16-22.  
T = Time from Block Arming Edge to First Sample

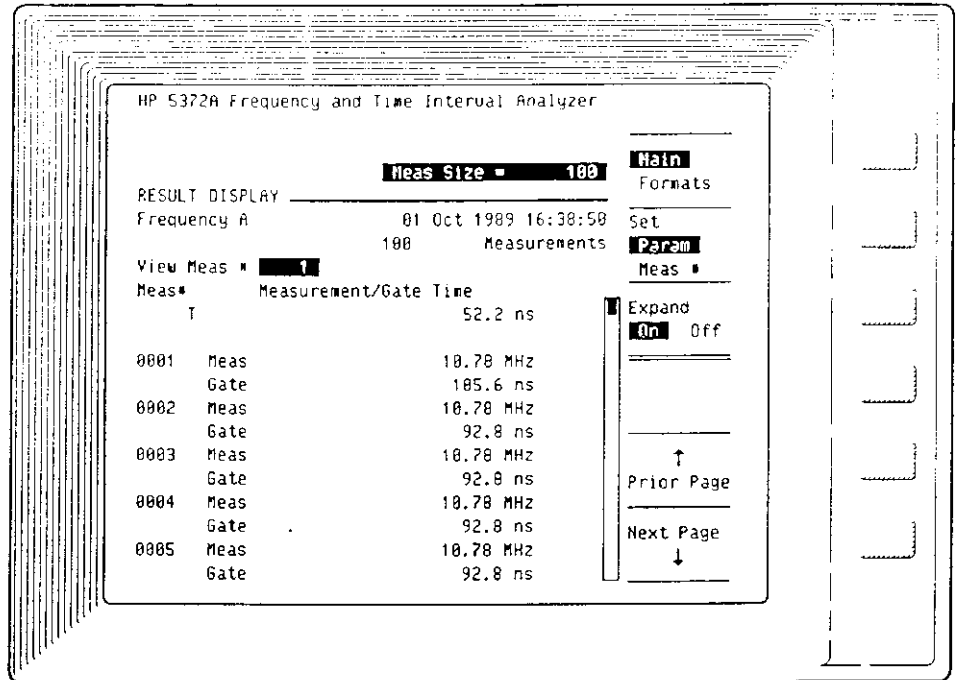

**TIME VARIATION GRAPH TIMING**

The averaged data points on the Time Variation graph are positioned at the center of their measurement intervals. The time value (x-axis) of the first measurement of the block is (the time from the block arming edge to the first sample of the measurement block) PLUS (half the measurement interval of the first measurement). The x-axis time to the subsequent measurements is always the time from the block holdoff edge to the middle of the measurement interval located by the active marker. Compare the x-axis marker information of the first measurement in Figure 16-23 to the time of the "T" value plus half the gate time of the first measurement in Figure 16-22.



Figure 16-23.  
Data Points are Located at  
the Center of Their  
Measurement Intervals

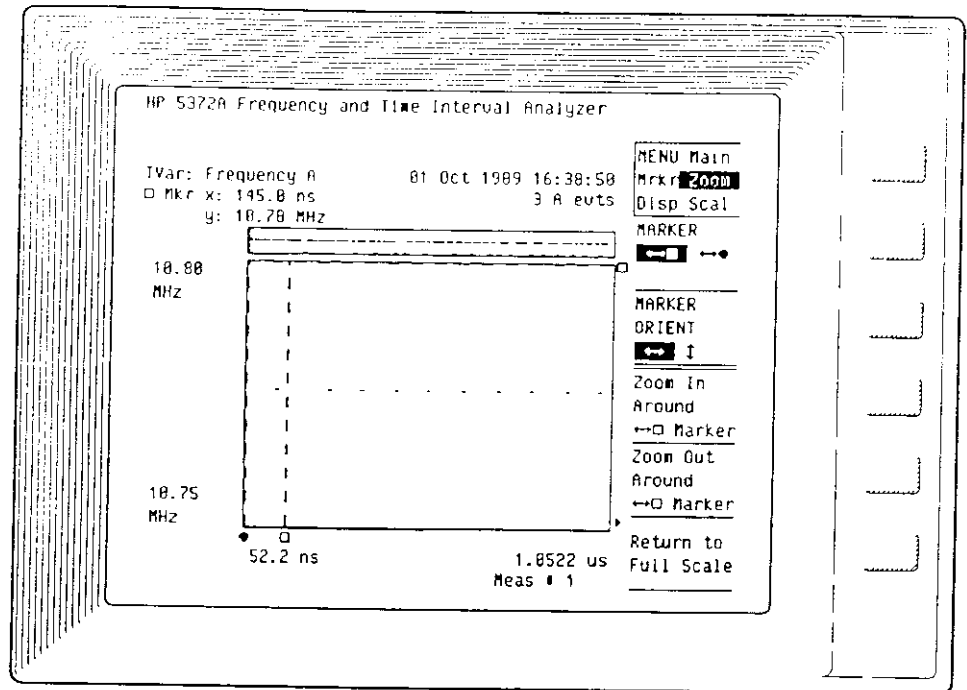

## Limit Lines on Time Variation

Limit lines on Time Variation graphs are two horizontal lines which overlay the graph. Their positions are dictated by the limit values entered on the Math menu. One line marks the low limit, and one marks the high limit. Limit lines are displayed when:

- the Limits feature is enabled on the Math menu for the channel being measured,
- the limit values are within the display range of the graph being viewed.

### Comments:

If one or both limit lines fail to appear on the graph, check the graph scale to make sure the limit values are within those spanned by the graph.

## PRE-TRIGGER AND TIME VARIATION

When a measurement sequence uses Pre-trigger, the measurement where the pre-trigger event occurred is identified with a "P" on the x-axis (see *Figure 16-24*). For information on how to use Pre-trigger, see chapter 10, "Pre-trigger Menu."

*Figure 16-24.*  
Pre-trigger on the Time Variation graph

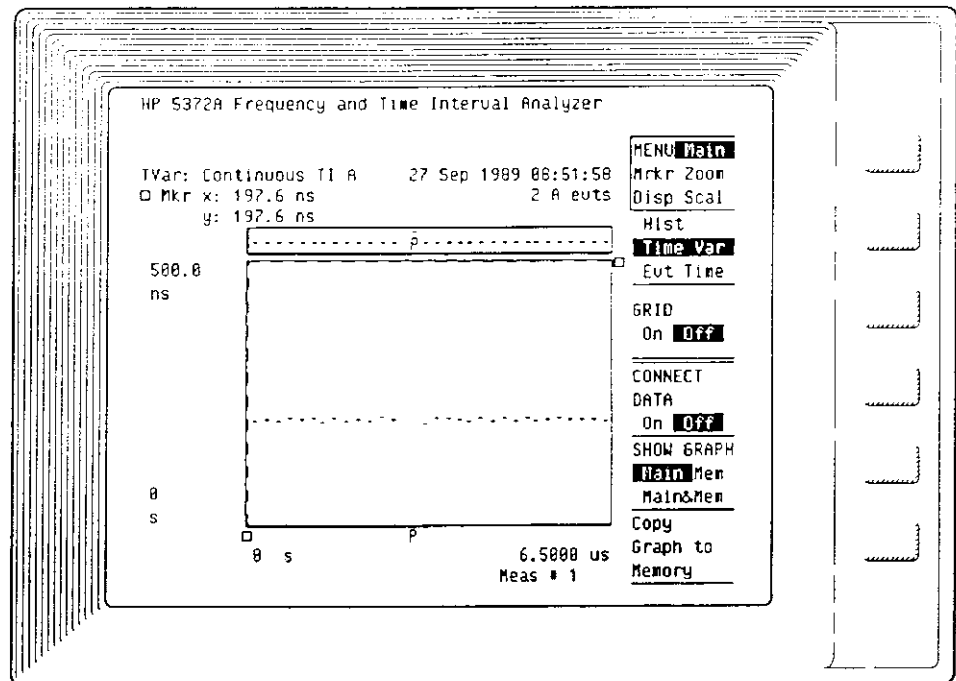

## MEASUREMENT INHIBIT ON TIME VARIATION

The Inhibit feature is used to selectively suppress the storage of measurement data. It is enabled on the Pre-trigger menu. The Inhibit signal polarity and voltage threshold are specified on the Pre-trigger menu. When the Inhibit feature is active, measurement data is not stored in measurement memory. Any input signal activity during Inhibit is not included in the measurement acquisition. The Time Variation graph shows an "I" to indicate measurements preceded or extended by Inhibit. Also, measurement number will have an "I" appended. Any measurements extended by Inhibit are not included in statistical or limit analysis. *Figure 16-25* shows a measurement sequence interrupted by Inhibit. For more on Inhibit, see chapter 10, "Pre-trigger Menu."

Figure 16-25.  
Measurement Inhibit on  
Time Variation Graph

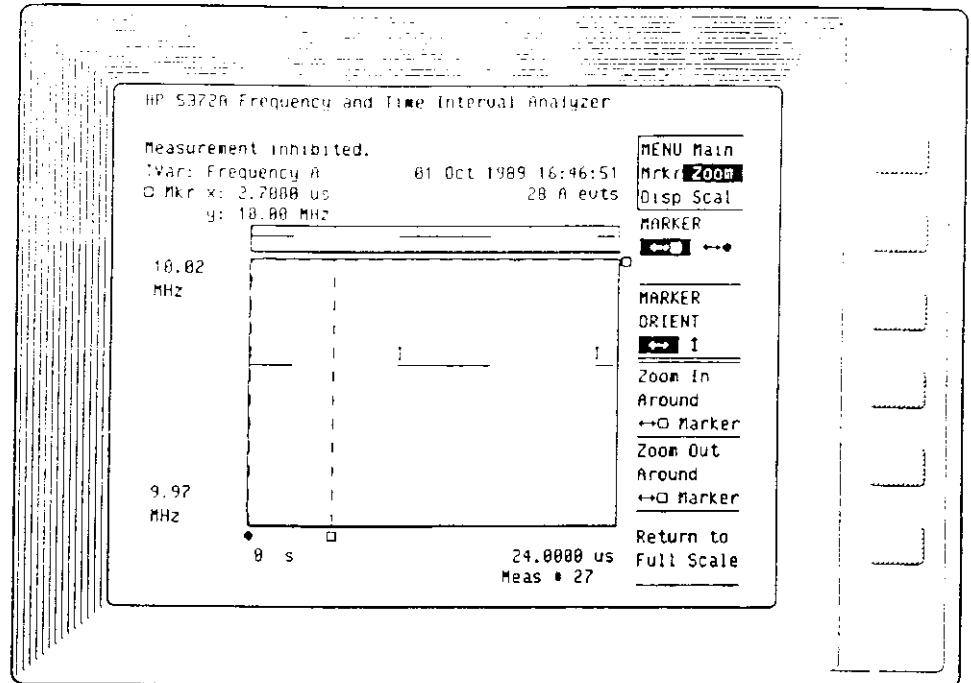

## EVENT TIMING GRAPH

The Event Timing graph plots the measurement start and stop values versus the actual time of the measurements. This graph is only available for time interval measurements (not Frequency, Period, or Totalize). The x-axis covers the time span over which the measurements were acquired. There is no y-axis for this graph; it is one-dimensional.

The graph is drawn as a single horizontal line, with short vertical lines (called ticks) above the horizontal line representing start measurement values, and the ticks below the horizontal line representing stop measurement values. For a given data point, the x-axis value is the actual start or stop time of the measurement relative to the first measurement in the sequence. For any x-axis value, there may be no ticks, a start tick, a stop tick, or both a start and a stop tick. Time-stamps, inhibits, and pre-trigger all appear on the Event Timing graph in the same way as for the Time Variation graph (T, I, P).

Figure 16-26 shows an Event Timing graph with information on the organization of the graph.

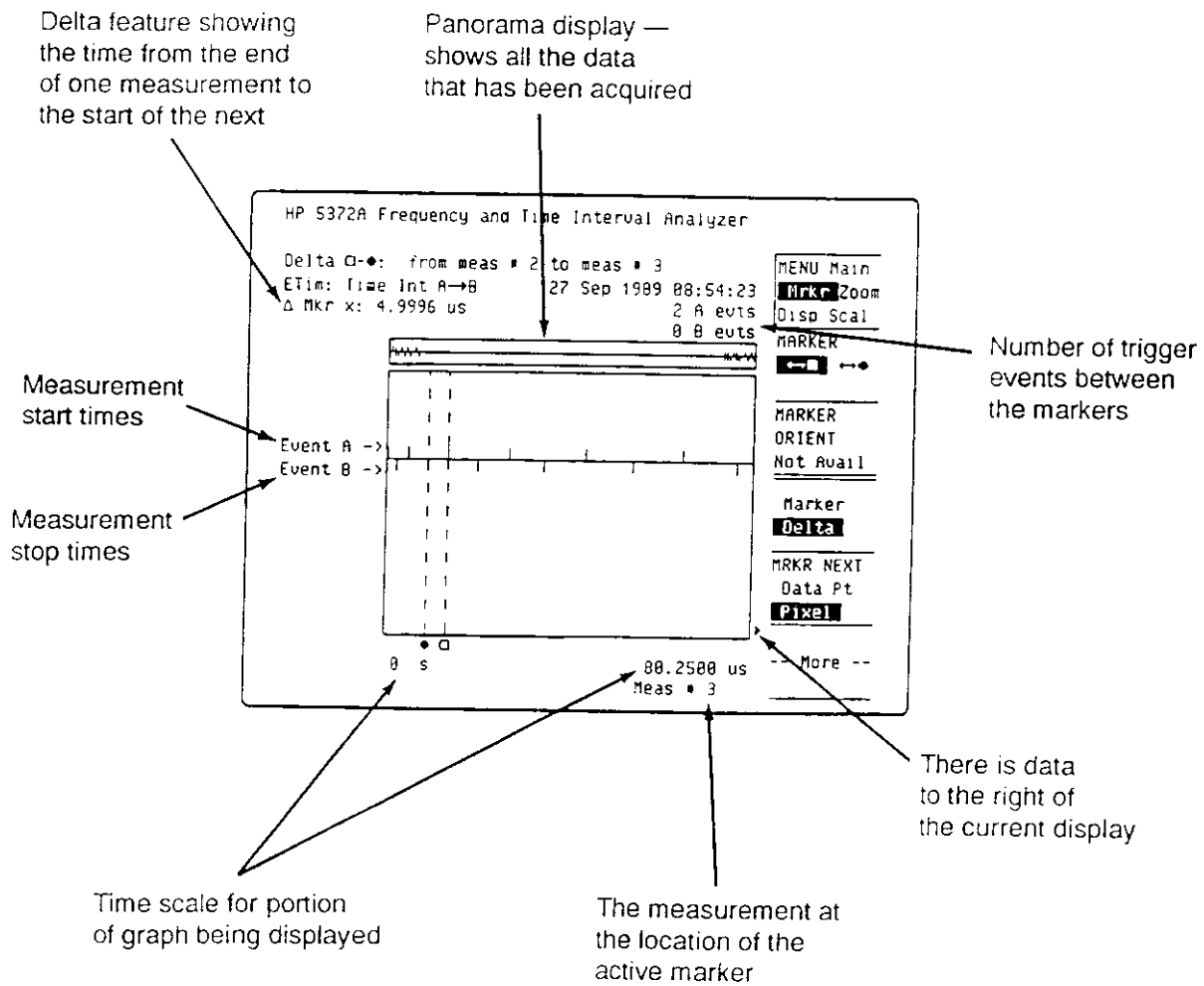

Figure 16-26. Event Timing Graph Organization

## Event Timing Display Options

There are no display options available for Event Timing graphs.

## Event Timing Scaling Options

- Manual Scaling

### AUTOSCALING:

- The x-axis values are determined by the time range delimited by the first and last measurements. The graph will fit within that range on the x-axis.

### MANUAL SCALING:

- For the x-axis, the user may enter a minimum and maximum value. Note that the x-axis is only in terms of actual measurement time. Therefore, the minimum and maximum values must both be greater than, or equal to, zero. If a negative number is entered, it will default to 0.

## PRESET VALUES

The following graphics conditions are set with the Preset key:

### ALL GRAPHS:

- Displayed graph = Histogram
- X- and Y-axis Manual Scaling Off
- Active Marker = ↔ □
- Marker Display Mode = Marker
- GRID Off
- MARKER NEXT = Pixel
- SHOW GRAPH = Main
- Memory Graph cleared

### HISTOGRAM:

- OUTLINE = On
- UPDATE = While
- YSCALE = Linear
- VIEW CHANNEL = A

### TIME VARIATION:

- CONNECT DATA Off
- VIEW CHANNEL = A

## **SAVED PARAMETERS**

The following parameters are stored when the instrument configuration is saved, or when the instrument is switched off:

- Graph type selected (Histogram or Time Variation or Event Timing)
- X- and Y-axis Manual Scaling status
- All Manual Scaling values
- Active marker and its orientation
- Marker Display Mode
- Grid status
- Marker locations
- Yscale mode
- Update mode
- Connect Data mode
- View Channel mode for Histogram and Time Variation

The following values are not saved:

- Memory Graph data
- Main Graph data
- Marker, delta, statistics, and modulation values from the graph data
- Event counts from the graph data
- Measurement number from the graph data
- Histogram underflow/overflow from the graph data
- Axes endpoints from the graph data

## Event Timing Main Options

- Grid

### GRID:

- The graph is divided by nine vertical lines. The spacing of the lines is not referenced to the displayed measurement results.

## Event Timing Marker Options

- Marker
- Delta
- Marker Next

### MARKER:

- Only  $\leftrightarrow\Box\leftrightarrow\bullet$  markers are available.
- The  $\leftrightarrow\Box\leftrightarrow\bullet$  markers provide an x-axis value that is the start or stop time of a measurement.

### DELTA:

- Delta is the difference in time of the current marker positions.

### MARKER NEXT:

- Data Pt — the active marker moves from measurement to measurement. When many measurements are combined into the 125 data columns, such as for a measurement size of 1,000 results or more, marker movement may appear sluggish because it is moving among multiple measurements within each column. As you zoom in on a graph, the display columns have fewer and fewer data points within them, until only one data point is shown per column, or no data points are contained in a column.
- Pixel — the active marker moves from display column to display column. This can be a faster way of scrolling through the data when the data is concentrated on the display. If multiple measurements are included in a column, the marker will only indicate the first measurement to occur in each column. This is evident from watching the 'Meas #' readout just below the graph x-axis values as the marker is scrolled across the display.

## Event Timing Zoom Options

- Zoom In
- Zoom Out

### ZOOM IN:

- There are 125 display columns across the graph area. When the number of measurements is such that they cannot all be assigned to individual display columns, only one measurement will be graphed per column. The graph must be zoomed in to resolve the overlapped data points into individual display columns.
- Pressing this softkey magnifies a portion of the graph, giving a close-up view of the data. The zoom action takes place around the active marker.
- The panorama display above the main display area always shows all the data that is available for viewing. There is a highlighted line segment under the panorama display that indicates the portion of the whole graph that is currently shown in the main display area.
- Use the **Return to Full Scale** softkey at any time to display all the measurement data that has been graphed.

### ZOOM OUT:

- The **Zoom Out** softkey performs the reverse of the **Zoom In** softkey. Approximately twice as much of the graph will be displayed each time the **Zoom Out** softkey is pressed.

### Comments:

You can zoom in on data of interest between two markers with a feature in the Scaling Options. Use the following steps:

1. Set markers to enclose data of interest.
2. Go to Scaling Options and press **Marker Range Hold X-axis** softkey.
3. Set Manual Scale to On.



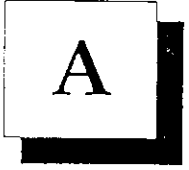

# Contents of Appendix

---

Introduction .....	A-1
Overview of Menu Maps .....	A-1



# A GUIDE TO THE FUNCTION MENU

---

## INTRODUCTION

Use this series of three menu maps to help understand the effects of the arming mode and the measurement size on the type of results that are available from the HP 5372A. These menu maps should be used as a guide. They are limited to showing single-channel measurements for the major measurement functions. The principles documented can be applied to the other measurement functions, once you understand the characteristics of those functions.

The following chapters of the Operating Manual should be used as reference material for this guide:

- Chapter 1, Time Interval Measurements
- Chapter 2, Frequency/Period Measurements
- Chapter 7, Function Menu
- Chapter 10, Pre-trigger Menu

## OVERVIEW OF MENU MAPS

The flowchart on the next page directs you to one of the menu maps depending on the size of the measurement and the kind of results you want. The purpose of each map is described briefly here:

- Menu Map A — This menu helps you to select the maximum number of measurements per block for a single-block measurement. All results are available for numeric and graphic analysis.
- Menu Map B — This menu helps you to select the maximum number of measurements per block for a multiple-block measurement so that all results are available for numeric and graphic analysis. It also shows the arming modes that provide averaging of results.

- Menu Map C — This menu covers the situations where measurement memory could be exceeded as a result of the multiple-block measurement size. When all the measurements will not fit in memory, not all results are available for review. There are times when this is preferable to using smaller measurement sizes. Some advantages are:
  - All the measurement values are included in statistics.
  - All the measurement values are included in limit testing.
  - All measurement values are included in Histogram graphs.
  - When averaging, the final block of measurements includes all the measurement values from each of the blocks.
  - Pre-trigger on multiple blocks provides the advantage of repeated execution of the block holdoff condition while waiting for the pre-trigger event. This sets a reference for each block of measurement data.

*See the  
Following Pages  
for Menu Maps*

# FUNCTION MENU GUIDE

## To Select a Menu Map:

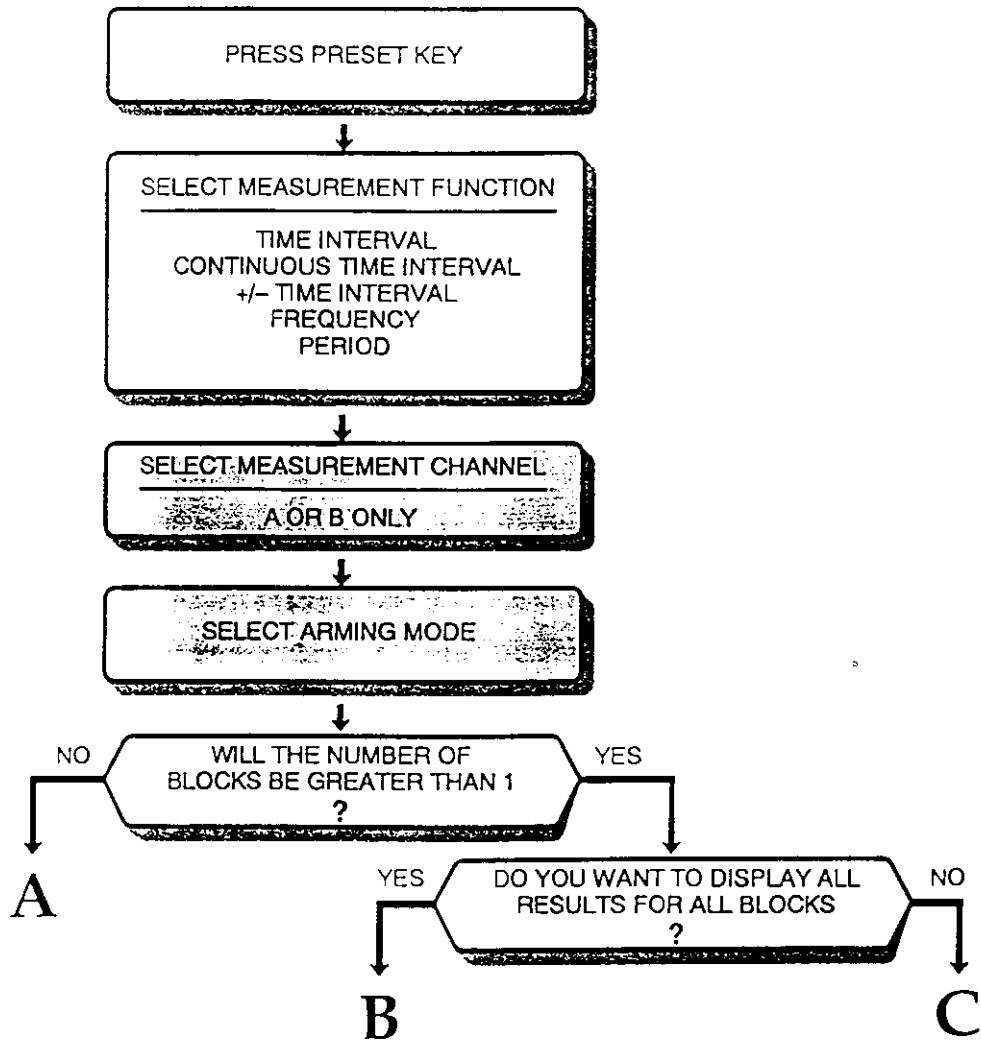

80\_TOPN3M

## PERFORMANCE TESTS

---

### INTRODUCTION

This chapter contains procedures for testing the electrical performance of the HP 5372A Frequency and Time Interval Analyzer, using specifications listed in Appendix E, as performance standards. Three types of testing are described: operation verification, complete performance testing, and HP-IB verification.

### NOTE

---

*If you are unfamiliar with the operation of the HP 5372A, we recommend you review the HP 5372A Getting Started Guide. This document is a "hands-on" tutorial which will help you become familiar with most of the instrument's features. By making the prescribed measurements and analyzing their results, you will be more comfortable pressing the front-panel keys and better understand the organization of the front panel controls.*

---

### OPERATION VERIFICATION

The Operation Verification is a set of tests which may be performed to give a high degree of confidence that the instrument is operating properly, without performing the complete Performance Tests. An Operation Verification is useful for incoming inspection, routine maintenance, and after instrument repair.

### PERFORMANCE TESTS

The complete Performance Tests verify the specifications listed in *Table 17-2*. All tests can be performed without access to the inside of the instrument.

### HP-IB VERIFICATION

The HP-IB Verification program exercises the instrument via the HP-IB interface. The program is written for a Series 200 or 300 HP 9000 as the controller. If the instrument successfully

completes all phases of the verification program, there is a very high probability that the HP-IB interface is working properly. The HP-IB program is available on floppy disks, HP Part Number 05372-13502 (5 1/4 inch LIF formatted disk) and HP Part Number 05372-13501 (3 1/2 inch LIF formatted disk).

**EQUIPMENT  
REQUIRED**

The equipment required for all test procedures in this chapter is listed in *Table 17-1*. Any equipment that satisfies the required characteristics given in the table may be substituted for the recommended models.

**CALIBRATION  
CYCLE**

The HP 5372A requires periodic verification of correct operation. Depending on use and environmental conditions, the HP 5372A should be checked using the Operation Verification and complete Performance Tests at least once a year.

**TEST RECORD**

Results of the Operation Verification, complete Performance Tests, and HP-IB Verification test should be recorded on a copy of the Performance Tests Record, located at the end of this chapter.



## Contents of Chapter

---

Introduction .....	17-1
Operation Verification .....	17-1
Performance Tests .....	17-1
HP-IB Verification .....	17-1
Equipment Required .....	17-2
Calibration Cycle .....	17-2
Test Record .....	17-2
Operation Verification Procedures .....	17-3
HP 5372A Setup .....	17-3
Power-Up Self Test and Diagnostics .....	17-4
Instrument Control .....	17-5
Measurement Functions .....	17-7
Arming Modes .....	17-9
Input Menu .....	17-11
Measurement Control .....	17-12
HP-IB and Print .....	17-16
Performance Test Procedures .....	17-17
Equipment Preliminary Setup .....	17-18
Channel A and B Tests .....	17-19
HP 5372A Configuration Setup .....	17-19
Channel A and B Frequency and Dynamic Ranges Test .....	17-27
Channel A and B Signal Operating Range Test .....	17-29
Channel A and B Manual Trigger Accuracy Test .....	17-30
Channel A and B Auto Trigger Tests .....	17-33
Channel A and B Sensitivity and Minimum Pulse Width Test (optional) .....	17-36
External Arm Input Tests .....	17-39
HP 5372A Configuration Setup .....	17-39
Front Panel External Arm Input Tests .....	17-43
External Arm Input Frequency and Dynamic Ranges Test .....	17-44
External Arm Input Signal Operating Range Test .....	17-46
External Arm Input Trigger Accuracy Test .....	17-47
External Arm Input Sensitivity and Minimum Pulse Width Test ..	17-48
Rear Panel External Arm Input Tests .....	17-49
Rear Panel External Arm Input Frequency and Dynamic Ranges Test .....	17-49
Rear Panel External Arm Input Signal Operating Range Test .....	17-52

Rear Panel External Arm Input Trigger Accuracy Test .....	17-53
Rear Panel External Arm Input Sensitivity and Minimum Pulse Width Test .....	17-54
Channel C Tests .....	17-55
HP 5372A Configuration Setup .....	17-55
Frequency Range/Dynamic Range/Sensitivity Test .....	17-57
HP-IB Verification Program .....	17-60
HP 5372A Performance Test Record .....	17-67

17/ PARODI RIVIANCI FISSI  
SISILIA ONNATA GONIA



Table 17-1. Equipment Required

INSTRUMENT	REQUIRED CHARACTERISTIC	RECOMMENDED MODEL
Synthesizer/Function Generator	DC to 10 MHz Frequency Range -15 mVp-p to 5 Vp-p Amplitude Range -2.5V to +2.5V DC Offset Range	HP 3325A
Synthesized Signal Generator	10 MHz to 2.0 GHz Frequency Range 12.6 mV rms to 707 mV rms Amplitude Range	HP 8663A
Digital Voltmeter	10 nV Resolution	HP 3458A
Pulse Generator	5 ns Pulse Width 280 mV p-p Amplitude 200 ns Period	HP 8161A
Attenuator	DC to 10 MHz Frequency Range 20 dB Attenuation	HP 8495D
Power Meter	100 MHz to 2 GHz	HP 436A
Power Sensor	100 MHz to 2 GHz -25 dBm to +7 dBm	HP 8481A
Power Splitter	100 MHz to 2 GHz	HP 11667A
Adapter	N(m)-to-BNC(f)	HP P/N 1250-0780
Adapter	Banana(m)-to-BNC(f)	HP 1251-2277
Adapter	BNC T-connector	HP 1250-0781
BNC Termination	50 ohm Feedthrough	HP 10100C
Adapters (2)	N(m)-to-SMA(f)	HP 1250-1250
Adapters (2)	N(m)-to-N(m)	HP 1250-0778
Cable	100 MHz to 2 GHz Frequency Range	Gore SN56181
Printer	ThinkJet	HP 2225A
Cable	HP-IB	HP 10833A

## OPERATION VERIFICATION PROCEDURES

### HP 5372A Setup

1. Insert 50  $\Omega$  BNC input pods (HP 54002A) into both Channel A and Channel B input pod slots in the front panel.
2. Attach a BNC T-connector to the HP 5372A rear-panel FREQUENCY STANDARD OUTPUT.
3. Connect a 4-foot BNC cable from the T-connector to the HP 5372A Channel A input pod.
4. Connect a 4-foot BNC cable from the T-connector to the HP 5372A Channel B input pod.

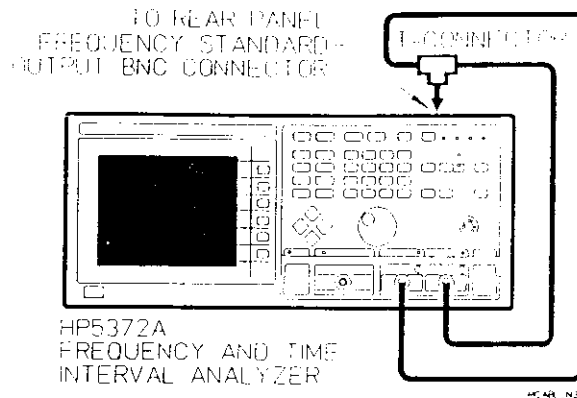

Figure 17-1. HP 5372A Operation Verification Setup

## Power-Up Self Test and Diagnostics

1. Before connecting the power cord and switching on the instrument, be sure that the line voltage selector is properly set, the correct fuse is installed, and all safety precautions have been observed.
2. Connect the HP 5372A power cord to the primary power source, and set the STBY-ON power switch to ON. Verify the Power-up Self Test routine, as follows:
  - a. After 3 seconds, the screen displays the words "Performing Self Test ..."
  - b. After a few more seconds, and if there are no error or failure messages, the Function screen is displayed.
  - c. If the HP 5372A displays an ERROR or FAILURE message, refer to the troubleshooting procedures in chapter 5 of the HP 5372A Service Manual. This chapter contains specific information about diagnostic failures.
3. Press Preset key.
4. Press Single/Repet key. The SINGLE LED should now be illuminated.

5. Press Test key.
6. Press "19" on the DATA ENTRY numeric keypad, and then press the Enter key.
7. Press the **Run** softkey.
8. Press the front-panel keys one at a time and verify the key name corresponds to the Front Panel Test "Key" field.
9. Move the Marker knob in both directions and verify the direction with the Front Panel Test "Key" field.
10. Press "21" on the DATA ENTRY numeric keypad, and then press the Enter key.
11. Press the **Run** softkey.
12. Verify that the CRT pattern covers the CRT display with a medium green color, and then press Test key.
13. Press "23" on the DATA ENTRY numeric keypad, and then press the Enter key.
14. Press the **Run** softkey.
15. After 30 seconds, verify that there are no Randomizer test failures, then press the **Stop** softkey.

## Instrument Control

### PRESET AND SHIFT-PRESET

1. Press Preset key.

#### **NOTE**

---

*Pressing the Preset key at any time resets the HP 5372A parameters (measurement function, channel(s), block and measurement sizes, arming mode, input trigger setting(s), etc.) to a default measurement setup. If the Preset key is pressed by mistake, the last instrument setup can be retrieved by pressing the Recall key and then entering "0" on the DATA ENTRY numeric keypad. The instrument setup at the time Preset is selected is saved in storage register "0".*

---

2. The Function screen should be displayed.

Verify the following fields:

“Measurement” field = Time Interval

“Channel” field = A

“Arming Mode” field = Automatic

3. The GATE LED should be blinking rapidly, while both the Channel A and Channel B trigger LEDs are blinking at a comparatively slower rate. (The TLK LED may be lighted, but will have no effect on the operation verification procedure.)
4. Press Shift and then press Preset key. (From now on this will be referred to as “Shift-Preset”.) This presets the instrument to a set of default values and state.
5. The Default Measurement Setup screen, Numeric screen in Results/Statistics mode, should be displayed.

Verify the following:

Mean = 100.0 ns  $\pm$  200 ps

Std Dev = 0 s up to 200 ps

### **SINGLE/REPET AND RESTART**

1. Press Single/Repet key.
2. The SINGLE LED will light and the GATE LED will turn off.
3. Press Restart key (The HP 5372A will make one block of measurements each time this key is pressed.)
4. The GATE LED should light up briefly each time Restart key is pressed in the single mode. The values displayed are from the block of measurements initiated by pressing Restart key. There may be little or no change in the values shown because the HP 5372A is measuring its FREQUENCY STANDARD OUTPUT, a very precise source.



## MANUAL ARMING

1. Press Preset key.
2. Press the **More** softkey.
3. Press the **Totalize** softkey.
4. Move the cursor to the "Arming Mode" field.
5. Press the top softkey until **Hld/Samp** is highlighted, and then press the **Manual** softkey.
6. Press Manual Arm key, wait about 1 second, and press Manual Arm key again.

### **NOTE**

---

*Press Restart before initializing a new Totalize measurement.*

---

7. The value displayed in the top right of the function screen should be proportional to the amount of time you waited before pressing Manual Arm key the second time in Step 6. For a one second time interval, the result should be 10.000 000 M.

## Measurement Functions

### **NOTE**

---

*The Time Interval measurement function is tested by the Instrument Control Block procedures (performed earlier in the Operation Verification) and therefore is not tested in the following procedures. In addition, Rise Time, Fall Time, Phase, Duty Cycle, Positive Pulse Width, Negative Pulse Width, and Period measurements are also not tested directly since they are variations of the measurements tested below.*

---

### ± TIME INTERVAL MEASUREMENT

1. Disconnect the BNC cable end from the Channel B input pod.
2. Press Preset key.
3. Press the ± Time Interval softkey.
4. Press Input key.
5. Press the **Common** softkey.
6. Press the Single/Repet key. The SINGLE LED should now be illuminated.
7. The result displayed should be  $0 \text{ s} \pm 200 \text{ ps}$ .
8. Reconnect the BNC cable end to the Channel B input pod.

### FREQUENCY MEASUREMENTS

1. Press Function key.
2. Press the **Frequency** softkey.
3. Move the cursor to the "Channel" field.
4. Press the **More** softkey until **A&B** is a menu selection option.
5. Press the **A&B** softkey.
6. The measurements shown at the top of the display should both be between 9.99 MHz and 10.01 MHz.

### PEAK AMPLITUDE MEASUREMENTS

1. Move the cursor to the "Measurement" field.
2. Press the **More** softkey until **Peak Amplitude** is a menu selection option.
3. Press the **Peak Amplitude** softkey.

5. Press Test key.
6. Press "19" on the DATA ENTRY numeric keypad, and then press the Enter key.
7. Press the **Run** softkey.
8. Press the front-panel keys one at a time and verify the key name corresponds to the Front Panel Test "Key" field.
9. Move the Marker knob in both directions and verify the direction with the Front Panel Test "Key" field.
10. Press "21" on the DATA ENTRY numeric keypad, and then press the Enter key.
11. Press the **Run** softkey.
12. Verify that the CRT pattern covers the CRT display with a medium green color, and then press Test key.
13. Press "23" on the DATA ENTRY numeric keypad, and then press the Enter key.
14. Press the **Run** softkey.
15. After 30 seconds, verify that there are no Randomizer test failures, then press the **Stop** softkey.

## Instrument Control

### PRESET AND SHIFT-PRESET

1. Press Preset key.

#### NOTE

---

*Pressing the Preset key at any time resets the HP 5372A parameters (measurement function, channel(s), block and measurement sizes, arming mode, input trigger setting(s), etc.) to a default measurement setup. If the Preset key is pressed by mistake, the last instrument setup can be retrieved by pressing the Recall key and then entering "0" on the DATA ENTRY numeric keypad. The instrument setup at the time Preset is selected is saved in storage register "0".*

---

2. The Function screen should be displayed.

Verify the following fields:

“Measurement” field = Time Interval

“Channel” field = A

“Arming Mode” field = Automatic

3. The GATE LED should be blinking rapidly, while both the Channel A and Channel B trigger LEDs are blinking at a comparatively slower rate. (The TLK LED may be lighted, but will have no effect on the operation verification procedure.)
4. Press Shift and then press Preset key. (From now on this will be referred to as “Shift-Preset”.) This presets the instrument to a set of default values and state.
5. The Default Measurement Setup screen, Numeric screen in Results/Statistics mode, should be displayed.

Verify the following:

Mean = 100.0 ns  $\pm$  200 ps

Std Dev = 0 s up to 200 ps

### **SINGLE/REPET AND RESTART**

1. Press Single / Repet key.
2. The SINGLE LED will light and the GATE LED will turn off.
3. Press Restart key (The HP 5372A will make one block of measurements each time this key is pressed.)
4. The GATE LED should light up briefly each time Restart key is pressed in the single mode. The values displayed are from the block of measurements initiated by pressing Restart key. There may be little or no change in the values shown because the HP 5372A is measuring its FREQUENCY STANDARD OUTPUT, a very precise source.

## MANUAL ARMING

1. Press Preset key.
2. Press the **More** softkey.
3. Press the **Totalize** softkey.
4. Move the cursor to the "Arming Mode" field.
5. Press the top softkey until **Hld/Samp** is highlighted, and then press the **Manual** softkey.
6. Press Manual Arm key, wait about 1 second, and press Manual Arm key again.

### NOTE

---

*Press Restart before initializing a new Totalize measurement.*

---

7. The value displayed in the top right of the function screen should be proportional to the amount of time you waited before pressing Manual Arm key the second time in Step 6. For a one second time interval, the result should be 10.000 000 M.

## Measurement Functions

### NOTE

---

*The Time Interval measurement function is tested by the Instrument Control Block procedures (performed earlier in the Operation Verification) and therefore is not tested in the following procedures. In addition, Rise Time, Fall Time, Phase, Duty Cycle, Positive Pulse Width, Negative Pulse Width, and Period measurements are also not tested directly since they are variations of the measurements tested below.*

---

#### ± TIME INTERVAL MEASUREMENT

1. Disconnect the BNC cable end from the Channel B input pod.
2. Press Preset key.
3. Press the ± Time Interval softkey.
4. Press Input key.
5. Press the **Common** softkey.
6. Press the Single/Repet key. The SINGLE LED should now be illuminated.
7. The result displayed should be  $0 \text{ s} \pm 200 \text{ ps}$ .
8. Reconnect the BNC cable end to the Channel B input pod.

#### FREQUENCY MEASUREMENTS

1. Press Function key.
2. Press the **Frequency** softkey.
3. Move the cursor to the "Channel" field.
4. Press the **More** softkey until **A&B** is a menu selection option.
5. Press the **A&B** softkey.
6. The measurements shown at the top of the display should both be between 9.99 MHz and 10.01 MHz.

#### PEAK AMPLITUDE MEASUREMENTS

1. Move the cursor to the "Measurement" field.
2. Press the **More** softkey until **Peak Amplitude** is a menu selection option.
3. Press the **Peak Amplitude** softkey.

4. The maximum should be above 350 mV. The minimum should be below -400 mV.
5. Move the cursor to the "Channel" field.
6. Press the **B** softkey.
7. The maximum should be above 350 mV. The minimum should be below -400 mV.

## Arming Modes

### NOTE

*An arming mode only needs to be tested in one measurement function to ensure correct operation.*

### FREQUENCY ARMING MODES

1. Press Preset key.
2. Press the **Frequency** softkey.
3. Move the cursor to the "Arming Mode" field.
4. Press the following softkeys and verify that the values displayed at the top of the Function screen are approximately the same as those below:

<b>Edge Holdoff</b>	10.00 MHz
<b>Time Holdoff</b>	10.00 MHz
<b>Event Holdoff</b>	10.00 MHz

5. Press the top softkey until **Sample** is highlighted and continue:

<b>Interval Sampling</b>	10.000 0 MHz
<b>Time Sampling</b>	10.000 000 000 MHz
<b>Cycle Sampling</b>	10.000 MHz
<b>Edge Sampling</b>	10.000 MHz

6. Press the top softkey until **Hld/Samp** is highlighted and continue:

<b>Edge/Interval</b>	10.000 0 MHz
<b>Edge/Time</b>	10.000 000 000 MHz
<b>Edge/Edge</b>	10.000 MHz

7. Press the **More** softkey and continue:

<b>Edge/Cycle</b>	10.000 MHz
<b>Edge/Event</b>	10.000 MHz
<b>Time/Interval</b>	10.000 0 MHz

8. Press the **More** softkey and continue:

<b>Time/Time</b>	10.000 000 000 MHz
<b>Event/Interval</b>	10.000 0 MHz
<b>Event/Event</b>	10.000 MHz
<b>Externally Gated</b>	10.00 MHz

± TIME INTERVAL ARMING MODES

1. Disconnect the BNC cable end from the Channel B input pod.
2. Press Preset key.
3. Press Input key.
4. Press the **Common** softkey.
5. Press Function key.
6. Press the ± **Time Interval** softkey.
7. Move the cursor to the "Arming Mode" field.
8. Press the top softkey until **Sample** is highlighted.
9. Press the following softkeys and verify that the values displayed at the top of the Function screen are approximately the same as those below:

<b>Parity Sampling</b>	0 s ± 200 ps
<b>Repetitive Edge</b>	0 s ± 200 ps

10. Press the **More** softkey and continue:

<b>Repetitive Edge/Parity</b>	0 s ± 200 ps
<b>Random Sampling</b>	0 s ± 200 ps



11. Press the top softkey until **H1d/Samp** is highlighted and continue:

**Edge/Parity**  $0\text{ s} \pm 200\text{ ps}$

12. Press the **More** softkey and continue:

**Edge/Random**  $0\text{ s} \pm 200\text{ ps}$

13. Reconnect the BNC cable end to the Channel B input pod.

## Input Menu

### SEPARATE/COMMON INPUT

1. Press Preset key.
2. The result at the top of the display should be  $100.0 \pm 0.2$  ns.
3. Move the cursor to the Channel field.
4. Press the **A→B** softkey.
5. The result displayed at the top right corner of the screen should be  $100 \pm 2$  ns.
6. Disconnect the BNC cable end from the Channel B input pod.
7. Press Input key.
8. Press the **Common** softkey. The value displayed should be  $100.0 \pm 2$  ns.
9. Reconnect the BNC cable end to the Channel B input pod.

### TRIGGER SLOPE

1. Move the cursor down to the Channel A "Slope" field and press the **Neg** softkey.
2. The result displayed at the top-right corner should now read approximately  $50\text{ ns} \pm 4\text{ ns}$ .

## Measurement Control

### PRE-TRIGGER, TI DETECT OUTPUT, AND MEASUREMENT INHIBIT INPUT

1. Press Preset key.
2. Press Single/Repet key. The SINGLE LED should now be illuminated.
3. Move the cursor to the “meas” field.
4. Press “10” on the DATA ENTRY numeric keypad, and then press the Enter key.
5. Move the cursor to the “Pre-trigger” field.
6. Press the **Pretrigger On** softkey.
7. Press Pre-trigger key.
8. Press the **External Arm** softkey.
9. Connect a BNC cable from the rear panel TI Detect output to the External Arm input.
10. Press Numeric key. The Numeric screen should display 10 measurements with the pre-trigger event (P event on display) at either measurement 5 or 6, as shown in *Figure 17-2*.

Figure 17-2.  
Numeric Display of  
Pre-trigger  
Measurement Result

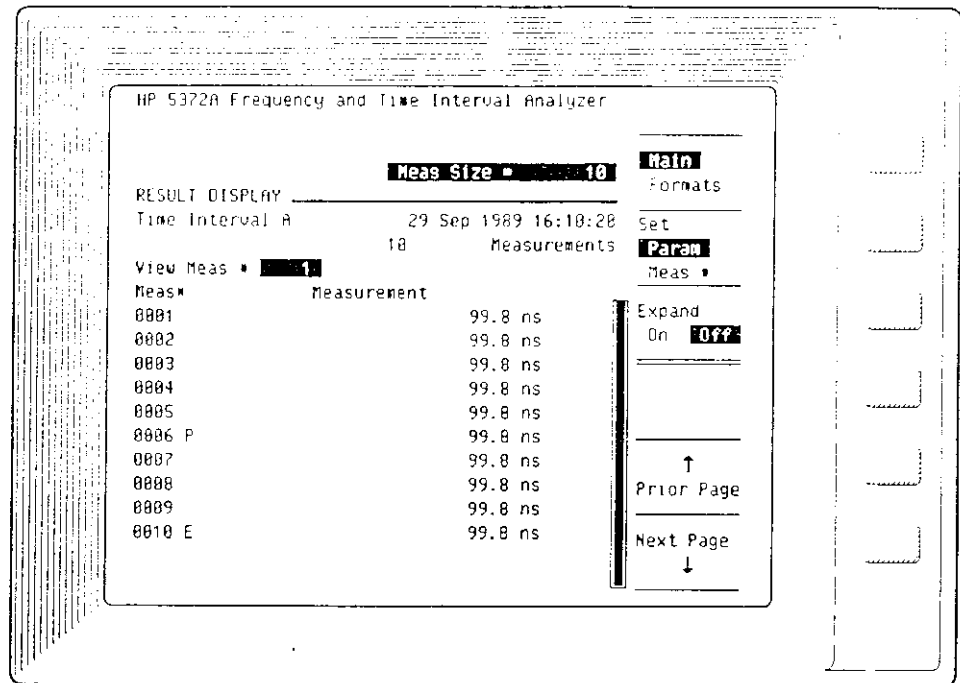

11. Press Pre-trigger key.
12. Press the **Time Interval** softkey.
13. Move the cursor to the TI Detect interval field (the current value of this field should be 0 s).
14. Press "105" on the DATA ENTRY numeric keypad, and then press the **ns** softkey. The top of the display should read "Waiting for pre-trigger..."
15. Press "95" on the DATA ENTRY numeric keypad, and then press the **ns** softkey. The top of the display should momentarily read "Events occurred which were not timed", and a measured result of  $100 \pm 0.2$  ns.
16. Move the cursor to the "Inhibit" field.
17. Press the **On** softkey. The top of the display should momentarily read "Events occurred which were not timed", and a measured result of  $100 \pm 0.2$  ns.

18. Move the cursor to the "inhibit input is" field.
19. Press the **Inhibit Below threshold** softkey. The top of the display should read "Measurement inhibited".
20. Disconnect the BNC cable from the rear panel TI Detect output and the External Arm input.

#### GATE 1 OUTPUT

1. Connect a BNC cable from the rear panel Gate 1 output to the Channel B input pod.
2. Press Preset key.
3. Press the **Frequency** softkey.
4. Move the cursor to the "Channel" field.
5. Press the **More** softkey until **A&B** is a menu selection option.
6. Press the **A&B** softkey.
7. Move the cursor to the "Arming Mode" field.
8. Press the **Interval Sampling** softkey.
9. Press Input key.
10. Move the cursor to the Channel B "Mode" field.
11. Press the **Manual Trig** softkey.
12. Move the cursor to the Channel B "Level" field.
13. Press "500" on the DATA ENTRY numeric keypad, and then press the **mV** softkey.
14. The top of the CRT should display:

Frequency A: 10.000 0 MHz  $\pm$  200 Hz  
Frequency B: 100.000 kHz  $\pm$  2 Hz

### GATE 2 OUTPUT

1. Disconnect the BNC cable end from the rear panel Gate 1 output and connect it to the rear panel Gate 2 output.
2. Press Function key.
3. Move the cursor to the "Channel" field.
4. Press the **More** softkey.
5. Press the **A** softkey.
6. Move the cursor to the Sample Arm "interval" field.
7. Press "1" on the DATA ENTRY numeric keypad, and then press the Enter key. The Channel B input trigger LED should flash once every second.

### ARM DELAY 1 OUTPUT

1. Disconnect the BNC cable end from the rear panel Gate 2 output and connect it to the rear panel Arm Delay 1 output.
2. Move the cursor to the "Arming Mode" field.
3. Press the top softkey until **Holdoff** is highlighted.
4. Press the **Time Holdoff** softkey.
5. Move the cursor to the Block Holdoff "Delay" field.
6. Press "1" on the DATA ENTRY numeric keypad, and then press the Enter key. The Channel B input trigger LED should flash once every second.

### ARM DELAY 2 OUTPUT

1. Disconnect the BNC cable end from the rear panel Arm Delay 1 output and connect it to the rear panel Arm Delay 2 output. The Channel B input trigger LED should flash once every second.

## HP-IB and Print

### NOTE

*Disconnect HP-IB interface cables that may be connected between the HP 5372A and an external controller before proceeding with the "HP-IB and Print" test.*

---

1. Press Preset key.
2. Press Single/Repet key. the SINGLE LED should now be illuminated.
3. Press System key.
4. Press the **Talk Only** softkey.
5. Move the cursor to the "Print" field.
6. Press the **Display** softkey.
7. Connect an HP-IB cable from the HP 5372A rear panel HP-IB Connector to an HP 2225A ThinkJet printer (or other similar HP-IB graphics printer).
8. Locate the row of switches on the rear panel of the printer. Set the switch that will enable the LISTEN ONLY mode for the printer (for the HP 2225A, set switch #2 up).
9. Connect the HP 2225A power cord to the primary power source, and set the power switch to ON.
10. Press HP 5372A Restart key.
11. Press Graphic key.
12. Press Print key. The printer should print a copy of the Graphic screen.

## PERFORMANCE TEST PROCEDURES

Table 17-2 lists a summary of the complete performance tests and the specifications tested.

Table 17-2. Specifications Tested by Performance Tests

PAGE NO.	TEST DESCRIPTION	SPECIFICATIONS TESTED
17-3	Operation Verification	Overall HP 5372A Operation
17-19	CHANNEL A AND B TESTS	
	Frequency Range	125 mHz to 500 MHz
	Dynamic Range	45 mVp-p to 2 Vp-p
	Signal Operating Range	-2 Vdc to +2 Vdc
	Manual Trigger Accuracy	20 mV $\pm$ 1% of setting
	Auto Trigger Tests	
	Frequency Range	1 kHz to 200 MHz
	Accuracy	$\pm$ 20% pk-pk amplitude
	Signal Op. Range	-2 Vdc to +2 Vdc
	Sensitivity	45 mVp-p with min pulse width
	Minimum Pulse Width	1 ns with 45 mVp-p amplitude 1.5 ns with 45 mVp-p amp (Holdoff Arming)
17-39	EXTERNAL ARM TESTS	
	FRONT PANEL TESTS	
	Frequency Range	DC to 100 MHz
	Dynamic Range	140 mVp-p to 5 Vp-p
	Signal Operating Range	-5 Vdc to +5 Vdc
	Trigger Accuracy	$\pm$ 20 mV or $\pm$ 10% of setting, whichever is greater
	Sensitivity	140 mVp-p with 5 ns pulse
	Minimum Pulse Width	5 ns with 140 mVp-p amplitude
	REAR PANEL TESTS	
	Frequency Range	DC to 100 MHz
	Dynamic Range	280 mVp-p to 5 Vp-p (DC to 20 MHz) 280 mVp-p to 2.5 Vp-p (20 MHz to 100 MHz)
	Signal Operating Range	-5 Vdc to +5 Vdc
	Trigger Accuracy	$\pm$ 20 mV or $\pm$ 10% of setting, whichever is greater
	Sensitivity	280 mVp-p with 5 ns pulse
	Minimum Pulse Width	5 ns with 280 mVp-p amplitude
17-55	CHANNEL C TESTS	
	Frequency Range	100 MHz to 2 GHz
	Dynamic Range:	
	100 MHz to 1.5 GHz	-25 dBm to 7 dBm
	>1.5 GHz to 2.0 GHz	-20 dBm to 7 dBm
	Sensitivity:	
	100 MHz to 1.5 GHz	-25 dBm
	>1.5 GHz to 2.0 GHz	-20 dBm
17-60	HP-IB Operation Verification Program	Overall HP-IB Operation

## Equipment Preliminary Setup

### HP 5372A PRELIMINARY SETUP

1. Disconnect any HP-IB cables from the rear panel.
2. Insert 50 $\Omega$  input pods (HP 54002A) into both Channel A and Channel B input pod slots in the front panel.
3. Before connecting the power cord and switching on the instrument, be sure the line voltage selector is properly set, the correct fuse is installed, and all safety precautions have been observed.
4. Connect the HP 5372A power cord to the primary power source, and set the STBY-ON power switch to ON. Verify the Power-Up Self Test routine, as follows:
5. After 3 seconds, the screen displays the words "Performing Self Test ..."
6. After a few more seconds, and if there are no error or failure messages, the Function screen is displayed. The CRT will display the message "Waiting for input signal..." if no input signal is present.
7. If the HP 5372A displays an ERROR or FAILURE message, refer to the troubleshooting procedures in chapter 5 of the HP 5372A Service Manual. This chapter contains specific information about diagnostic failures.
8. Press Instrument State key. If the write protection for any register 1 through 9 is ON, use the **Off** softkey to turn off the write protection.

### TEST EQUIPMENT PRELIMINARY SETUP

1. Disconnect any HP-IB cables from the rear panels.
2. Connect the power cords to the primary power source, and allow at least twenty minutes warmup before using the instruments.
3. Set the power switch from STBY to ON.
4. If the display indicates that there are any errors, refer to the appropriate operating manual.



## CHANNEL A AND B TESTS

### Specifications Tested:

125 mHz to 500 MHz Frequency Range

45 mVp-p to 2 Vp-p Dynamic Range

-2 V to +2 V Signal Operating Range

20 mV  $\pm$  1% of setting Manual Trigger Accuracy

### AUTO TRIGGER TESTS

1 kHz to 200 MHz Frequency Range

200 mVp-p to 2 Vp-p Dynamic Range

$\pm$  20% of pk-pk amplitude Accuracy

-2 V to +2 V Signal Operating Range

45 mVp-p Sensitivity at minimum pulse width

1 ns Minimum Pulse Width at minimum amplitude

1.5 ns Min Pulse Width at minimum amplitude (Holdoff Arming)

### Equipment:

HP 3325A Synthesizer/Function Generator

HP 8663A Synthesized Signal Generator

**Description:** The Channel A and B Tests consists of five separate test procedures, which verify the above specifications. The first test verifies both the frequency range and dynamic range, the second test verifies the signal operating range, the third test verifies the manual trigger accuracy, the fourth test verifies the auto trigger frequency range, dynamic range, accuracy, and signal operating range, and the fifth test (optional) verifies both the sensitivity and minimum pulse width.

## HP 5372A Configuration Setup

### NOTE

---

*This procedure sets the HP 5372A Function and Input menus to specific configurations which will be used in the Channel A and B Tests. The configurations are stored in memory using the Save key, and are then recalled from memory during the Performance Tests using the Recall key.*

---

1. Press Preset key.
2. Press the **F**requency softkey.

3. Move the cursor to the "meas" field.
4. Press "1" on the DATA ENTRY numeric keypad, and then press the Enter key.
5. Move the cursor to the "Arming Mode" field.
6. Press the top softkey until **Sample** is highlighted.
7. Press the **Interval Sampling** softkey.
8. Move the cursor to the Sample Arm "intervals" field.
9. Press "1" on the DATA ENTRY numeric keypad, and then press the Enter key.
10. Press Input key.
11. Move the cursor to the Channel A "Mode" field.
12. Press the **Manual Trig** softkey.
13. Move the cursor to the Channel B "Mode" field.
14. Press the **Manual Trig** softkey.
15. Press Single/Repet key. The SINGLE LED should now be illuminated.
16. Press Save key, and then enter "1" on the DATA ENTRY numeric keypad.
17. Press Function key.
18. Move the cursor to the "Channel" field.
19. Press the **More** softkey.
20. Press the **B** softkey.
21. Press Save key, and then enter "2" on the DATA ENTRY numeric keypad.
22. Press the **More** softkey until **A&B** is a menu selection option.
23. Press the **A&B** softkey.
24. Press Input key.

HP 5372A Frequency and Time Interval Analyzer

Waiting for input signal...

Frequency A:

FUNCTION

Frequency Measurement Channel A  
 Acquire 1 block of 1 meas  
 Pre-trigger Off Total Meas = 1

Interval Sampling Arming Mode

Block Holdoff:

Arm a block of measurements automatically

Sample Arm:

Sampling on meas channel after  
 1.0000000 s intervals

Acquisition Time/Block = 1.0000 s

HP 5372A Frequency and Time Interval Analyzer

Waiting for input signal...

Frequency A:

INPUT

Separate Input Channels

Trigger Event:

	Slope	Mode	Level
Chan A:	Pos	Manual	0 V
Chan B:	Pos	Manual	0 V
Chan C:	POS	MANUAL	0 V
Ext Arm Level	0 V		

	Channel A	Channel B	Channel C
Input Pod	HP 54002A	HP 54002A	----
Impedance	50 $\Omega$	50 $\Omega$	50 $\Omega$
Bias Level	GND	GND	GND
Attenuation	1:1	1:1	0 %
Hysteresis	Min	Min	----
Max Input	2 V peak	2 V peak	+20 dBm

Manual Trig

Single Auto Trig

Repetitive Auto Trig

Figure 17-3. Channel A and B Configuration 1

HP 5372A Frequency and Time Interval Analyzer

Waiting for input signal...

Frequency B:

FUNCTION

Frequency Measurement Channel B  
 Acquire 1 block of 1 meas  
 Pre-trigger Off Total Meas = 1

Interval Sampling Arming Mode

Block Holdoff:

Arm a block of measurements automatically

Sample Arm:

Arm sampling on meas channel after  
 1.0000000 s intervals

Acquisition Time/Block = 1.0000 s

B

B / A

B / C

B - A

B - C

-- More --

HP 5372A Frequency and Time Interval Analyzer

Waiting for input signal...

Frequency B:

INPUT

Separate Input Channels

Trigger Event:

	Slope	Mode	Level
Chan A:	Pos	Manual	0 V
Chan B:	Pos	Manual	0 V
Chan C:	POS	MANUAL	0 V
Ext Arm Level	0 V		

	Channel A	Channel B	Channel C
Input Pod	HP 54002A	HP 54002A	----
Impedance	50 $\Omega$	50 $\Omega$	50 $\Omega$
Bias Level	GND	GND	GND
Attenuation	1:1	1:1	0 %
Hysteresis	Min	Min	----
Max Input	2 V peak	2 V peak	+20 dBm

Manual Trig

Single Auto Trig

Repetitive Auto Trig

Figure 17-4. Channel A and B Configuration 2

```

HP 5372A Frequency and Time Interval Analyzer

Waiting for input signal...
Frequency A:
Frequency B:
FUNCTION
Frequency Measurement Channel A & B
Acquire 1 block of 1 meas
Pre-trigger Off Total Meas = 1

Interval Sampling Arming Mode
Block Holdoff:
Arm a block of measurements automatically

Sample Arm:
Arm sampling on meas channel after
1.0000000 s intervals
Acquisition Time/Block = 1.0000 s
    
```

```

A & B
A & C
B & C
-- More --
    
```

```

HP 5372A Frequency and Time Interval Analyzer

Waiting for input signal...
Frequency A:
Frequency B:
INPUT
Common Input Channels [Ch A -> Ch A & B]
Trigger Event:
Slope Mode Level
Chan A: Pos Manual 0 V
Chan B: Pos Manual 0 V
Chan C: POS MANUAL 0 V
Ext Arm Level 0 V

Channel A Channel B Channel C
Input Pod HP 54002A HP 54002A -----
Impedance 50 Ω 50 Ω 50 Ω
Bias Level GND GND GND
Attenuation 1:1 1:1 0 %
Hysteresis Min Min -----
Max Input 2 V peak 2 V peak +20 dBm
    
```

```

Separate
Common
-----
-----
-----
-----
-----
-----
    
```

Figure 17-5. Channel A and B Configuration 3

```

HP 5372A Frequency and Time Interval Analyzer

Waiting for input signal...
Frequency A:
Frequency B:
FUNCTION
Frequency Measurement Channel A & B
Acquire 1 block of 1 meas
Pre-trigger Off Total Meas = 1

Interval Sampling Arming Mode
Block Holdoff:
Arm a block of measurements automatically

Sample Arm:
Arm sampling on meas channel after
1.0000000 s intervals
Acquisition Time/Block = 1.0000 s
    
```

```

A & B
A & C
B & C
-- More --
    
```

```

HP 5372A Frequency and Time Interval Analyzer

Waiting for input signal...
Frequency A:
Frequency B:
INPUT
Common Input Channels [Ch A -> Ch A & B]
Trigger Event:
Slope Mode Level
Chan A: Pos Manual 1.000 V
Chan B: Pos Manual 1.000 V
Chan C: POS MANUAL 0 V
Ext Arm Level 0 V

Channel A Channel B Channel C
Input Pod HP 54002A HP 54002A -----
Impedance 50 Ω 50 Ω 50 Ω
Bias Level GND GND GND
Attenuation 1:1 1:1 0 %
Hysteresis Min Min -----
Max Input 2 V peak 2 V peak +20 dBm
    
```

```

0 V
TTL Preset [ 1.4 V]
ECL Preset [-1.3 V]
-----
-----
-----
-----
-----
    
```

Figure 17-6. Channel A and B Configuration 4

HP 5372A Frequency and Time Interval Analyzer

```

Waiting for input signal...
Frequency A: A & B
Frequency B:
FUNCTION
Frequency Measurement Channel A & B
Acquire 1 block of 1 meas
Pre-trigger Off Total Meas = 1

Interval Sampling Arming Mode
Block Holdoff:
Arm a block of measurements automatically

Sample Arm:
Arm sampling on meas channel after
1.0000000 s intervals
Acquisition Time/Block = 1.0000 s
    
```

HP 5372A Frequency and Time Interval Analyzer

```

Waiting for input signal...
Frequency A: 0 V
Frequency B:
INPUT Common Input Channels [Ch A -> Ch A & B] TTL Preset [1.4 V]
Trigger Event:
Slope Mode Level
Chan A: Pos Manual -1.000 V ECL Preset [-1.3 V]
Chan B: Pos Manual -1.000 V
Chan C: POS MANUAL 0 V
Ext Arm Level 0 V

Channel A Channel B Channel C
Input Pod HP 54002A HP 54002A -----
Impedance 50 Ω 50 Ω 50 Ω
Bias Level GND GND GND
Attenuation 1:1 1:1 0 %
Hysteresis Min Min -----
Max Input 2 V peak 2 V peak +20 dBm
    
```

Figure 17-7. Channel A and B Configuration 5

HP 5372A Frequency and Time Interval Analyzer

```

Waiting for input signal...
Frequency A: A
FUNCTION
Frequency Measurement Channel A A / B
Acquire 1 block of 1 meas
Pre-trigger Off Total Meas = 1

Interval Sampling Arming Mode
Block Holdoff:
Arm a block of measurements automatically

Sample Arm:
Arm sampling on meas channel after
1.0000000 s intervals
Acquisition Time/Block = 1.0000 s
    
```

HP 5372A Frequency and Time Interval Analyzer

```

Waiting for input signal...
Frequency A: Min
INPUT Separate Input Channels Max
Trigger Event:
Slope Mode Level
Chan A: Pos Manual 998 mV
Chan B: Pos Manual 998 mV
Chan C: POS MANUAL 0 V
Ext Arm Level 0 V

Channel A Channel B Channel C
Input Pod HP 54002A HP 54002A -----
Impedance 50 Ω 50 Ω 50 Ω
Bias Level GND GND GND
Attenuation 1:1 1:1 0 %
Hysteresis Max Max -----
Max Input 2 V peak 2 V peak +20 dBm
    
```

Figure 17-8. Channel A and B Configuration 6 (Repet mode)

```

HP 5372A Frequency and Time Interval Analyzer

Waiting for input signal...
Frequency B: 0

FUNCTION
Frequency Measurement Channel B
Acquire 1 block of 1 meas
Pre-trigger Off Total Meas = 1

Interval Sampling Arming Mode
Block Holdoff:
Arm a block of measurements automatically

Sample Arm:
Arm sampling on meas channel after
1.0000000 s intervals
Acquisition Time/Block = 1.0000 s
    
```

```

HP 5372A Frequency and Time Interval Analyzer

Waiting for input signal...
Frequency B: Min

INPUT
Separate Input Channels Max
Trigger Event:
Slope Mode Level
Chan A: Pos Manual 998 mV
Chan B: Pos Manual 998 mV
Chan C: POS MANUAL 0 V
Ext Arm Level 0 V

Channel A Channel B Channel C
Input Pod HP 54002A HP 54002A -----
Impedance 50 Ω 50 Ω 50 Ω
Bias Level GND GND GND
Attenuation 1:1 1:1 0 %
Hysteresis Max Max -----
Max Input 2 V peak 2 V peak +20 dBm
    
```

Figure 17-9. Channel A and B Configuration 7 (Repet mode)

```

HP 5372A Frequency and Time Interval Analyzer

Max Amplitude A: 2 mV Duty Cycle
Min Amplitude A: 2 mV
FUNCTION
Peak Amplitude Measurement Channel A
Acquire 1 block of 1 meas
Pre-trigger Off Total Meas = 1

Automatic Arming Mode
Block Holdoff:
Arm a block of measurements automatically

Sample Arm:
Arm sampling on meas channel automatically

-- More --
    
```

```

HP 5372A Frequency and Time Interval Analyzer

Max Amplitude A: 2 mV Separate
Min Amplitude A: 2 mV
INPUT
Separate Input Channels Common
Trigger Event:
Slope Mode Level
Chan A: Pos Sgl Auto 50 % = 2 mV
Chan B: Pos Sgl Auto 50 % = 0 V
Chan C: POS MANUAL 0 V
Ext Arm Level 0 V

Channel A Channel B Channel C
Input Pod HP 54002A HP 54002A -----
Impedance 50 Ω 50 Ω 50 Ω
Bias Level GND GND GND
Attenuation 1:1 1:1 0 %
Hysteresis Min Min -----
Max Input 2 V peak 2 V peak +20 dBm
    
```

Figure 17-10. Channel A and B Configuration 8

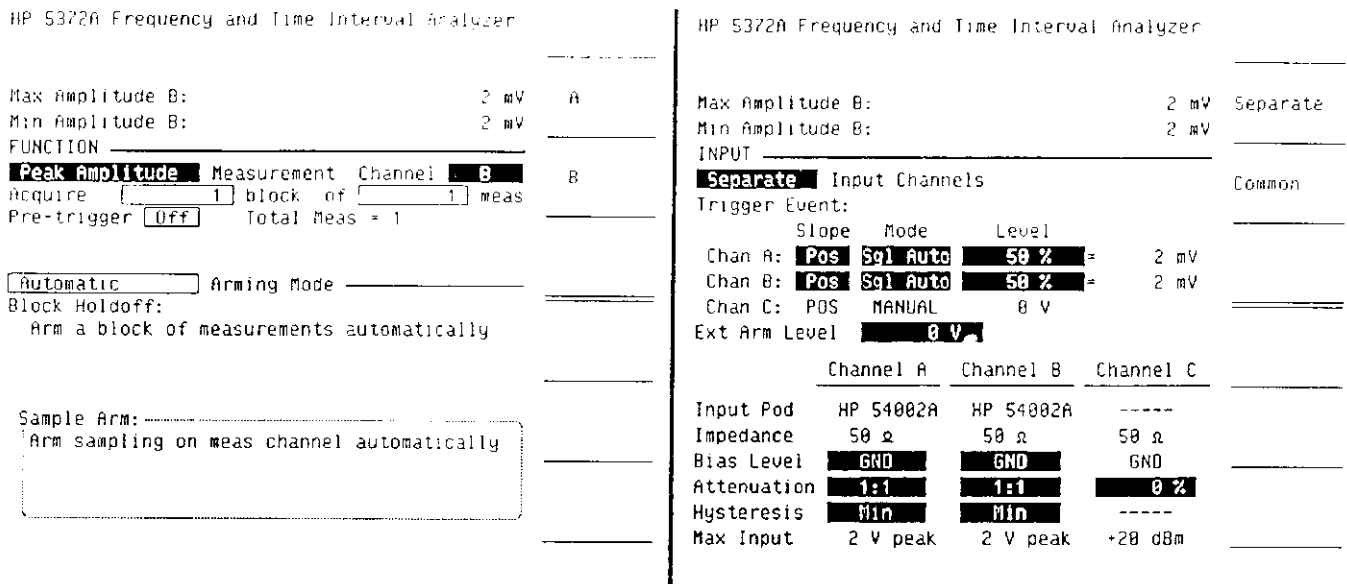

Figure 17-11. Channel A and B Configuration 9

## Channel A and B Frequency and Dynamic Ranges Test

Specifications Tested: 125 MHz to 500 MHz  
45 mVp-p to 2 Vp-p

### HP 3325A SETUP

1. Press the **FREQ** key, enter ".125", and press **Hz** key.
2. Press the **AMPTD** key, enter "45", and press **mV** key.
3. Press the **DC OFFSET** key, enter "0", and press **mV** key.
4. Select the sine wave (20 MHz) function.
5. Connect a BNC cable from the **SIGNAL** output to the HP 5372A Channel A input pod.
6. Connect a BNC cable from the rear panel **EXT REF IN** to the HP 5372A rear panel **FREQUENCY STANDARD OUTPUT** (the HP 3325A front-panel **EXT REF LED** should be illuminated).

### HP 8663A SETUP

1. Press the FREQUENCY key, enter "500", and press MHz key.
2. Press the AMPLITUDE key, enter "15", and press mV key.
3. Attach a N(m)-to-BNC(f) adapter (HP # 1250-0780) to the RF OUTPUT connector.

### FREQUENCY RANGE AND DYNAMIC RANGE TEST PROCEDURE

1. Press Recall key, and then enter "1" on the DATA ENTRY numeric keypad.

#### **NOTE**

---

*The HP 5372A requires 8 seconds to perform each .125 Hz test.*

---

2. After 8 seconds, the top of the HP 5372A CRT should display a result for Channel A. Enter this value on the Performance Test Record.
3. Disconnect the BNC cable from the HP 5372A Channel A input pod and connect it to the HP 5372A Channel B input pod.
4. Press Recall key, and then enter "2" on the DATA ENTRY numeric keypad.
5. After 8 seconds, the top of the HP 5372A CRT should display a result for Channel B. Enter this value on the Performance Test Record.
6. Press the HP 3325A AMPTD key, enter "2", and press VOLT key.
7. Press the HP 3325A square wave (10 MHz) function key.
8. Press HP 5372A Restart key.
9. After 8 seconds, the top of the HP 5372A CRT should display a result for Channel B. Enter this value on the Performance Test Record.



10. Disconnect the BNC cable from the HP 5372A Channel B input pod and connect it to the HP 5372A Channel A input pod.
11. Press Recall key, and then enter "1" on the DATA ENTRY numeric keypad.
12. After 8 seconds, the top of the HP 5372A CRT should display a result for Channel A. Enter this value on the Performance Test Record.
13. Disconnect the BNC cable end from the HP 3325A SIGNAL output, and connect it to the HP 8663A RF OUTPUT.
14. Disconnect the BNC cable end from the HP 3325A rear panel EXT REF IN, and connect it to the HP 8663A rear panel time base input.
15. Press Numeric key.
16. Press Recall key, and then enter "3" on the DATA ENTRY numeric keypad.
17. The HP 5372A CRT should display results for both Channel A and B. Enter these values on the Performance Test Record.
18. Press the HP 8663A AMPLITUDE key, enter "10", and press +dBm key (The +10 dBm amplitude is equivalent to 2 Vp-p).
19. Press HP 5372A Restart key.
20. The HP 5372A CRT should display results for both Channel A and B. Enter these values on the Performance Test Record.

**Channel A and B  
Signal Operating  
Range Test**

Specification Tested:  
-2 Vdc to +2 Vdc

**HP 3325A SETUP**

1. Press the FREQ key, enter "10", and press MHz key.
2. Press the AMPID key, enter "2", and press VOLT key.

3. Press the DC OFFSET key, enter "1", and press VOLT key.
4. Select the sine wave (20 MHz) function key.
5. Connect a BNC cable from the SIGNAL output to the HP 5372A Channel A input pod.
6. Connect a BNC cable from the rear panel EXT REF IN to the HP 5372A rear panel FREQUENCY STANDARD OUTPUT.

#### SIGNAL OPERATING RANGE TEST PROCEDURE

1. Press Recall key, and then enter "4" on the DATA ENTRY numeric keypad.
2. The HP 5372A CRT should display results for both Channel A and B. Enter these values on the Performance Test Record.
3. Press the HP 3325A DC OFFSET key, enter "-1", and press VOLT key.
4. Press Recall key, and then enter "5" on the DATA ENTRY numeric keypad.
5. The HP 5372A CRT should display results for both Channel A and B. Enter these values on the Performance Test Record.

#### Channel A and B Manual Trigger Accuracy Test

Specification Tested:  
20 mV  $\pm$  1% of setting

#### HP 3458A SETUP

1. Connect a Banana-to-BNC adapter to the 2 wire input.

#### HP 3325A SETUP

1. Press the FREQ key, enter "10", and press kHz key.
2. Press the AMP TD key, enter "1.0", and press VOLT key.
3. Connect a BNC T-Connector to the SIGNAL output.

4. Connect a BNC cable from one end of the BNC T-Connector to the HP 5372A Channel A input pod.
5. Connect a BNC cable from one end of the BNC T-Connector to the HP 3458A Multimeter.
6. Connect a BNC cable from the rear panel EXT REF IN to the HP 5372A rear panel FREQUENCY STANDARD OUTPUT.

#### MANUAL TRIGGER ACCURACY TEST PROCEDURE

1. Press Recall key, and then enter "6" on the DATA ENTRY numeric keypad.
2. Press the HP 3325A DC OFFSET key, enter "998", and press mV key.
3. Press HP 5372A Math key.
4. Press the **Set Ch A Reference** softkey.
5. Move the cursor to the Channel A "Limits" field.
6. Press the **On** softkey.
7. Move the cursor to the Channel A "Low Limit" field.
8. Press "-100" on the DATA ENTRY numeric keypad, and then press the Enter key.
9. Move the cursor to the Channel A "High Limit" field.
10. Press "100" on the DATA ENTRY numeric keypad, and then press the Enter key.
11. Press the HP 3325A DC OFFSET key, enter "1.45", and then press VOLT key.
12. Press Numeric key.
13. Using the HP 3325A MODIFY keys, increase the DC OFFSET to the maximum level that allows all measurements to "Pass" the Limit test (The "Limit" test displays either "Pass", "High", or "Low", depending on whether the measurement was within the limits, greater than the high limit, or below the low limit, respectively). Begin the test by incrementing in 10 mV steps until the

“High” or “Low” limit is displayed. Then, decrease the DC OFFSET 10 mV, and finally increase in 1 mV steps to the maximum level that allows all measurements to “Pass”. Record the DC OFFSET value, from the HP 3458A display, on the Performance Test Record.

14. Press the HP 3325A DC OFFSET key, enter “550”, and press mV key.
15. Using the HP 3325A MODIFY keys, decrease the DC OFFSET to the minimum level that allows all measurements to “Pass” the Limit test. Begin the test by decrementing in 10 mV steps until the “High” or “Low” limit is displayed. Then, increase the DC OFFSET 10 mV, and finally decrease in 1 mV steps to the minimum level that allows all measurements to “Pass”. Record the DC OFFSET value, from the HP 3458A display, on the Performance Test Record.
16. Calculate the average of the two recorded DC OFFSET values, and then subtract 998 mV (HP 5372A trigger level) from the average. Record this result on the Performance Test Record.
17. Disconnect the BNC cable end from the HP 5372A Channel A input pod and connect it to the HP 5372A Channel B input pod.
18. Press Recall key, and then enter “7” on the DATA ENTRY numeric keypad.
19. Repeat the above procedure for Channel B (Begin at Step 2).

## Channel A and B Auto Trigger Tests

### Specifications Tested:

- 1 kHz to 200 MHz Frequency Range
- 200 mVp-p to 2 Vp-p Dynamic Range
- ± 20% of pk-pk amplitude Accuracy
- 2 V to +2 V Signal Operating Range

---

### NOTE

*The Peak Amplitude function specifications are tested in the Auto Trigger tests.*

---

### HP 3325A SETUP

1. Press the **FREQ** key, enter "1", and press **kHz** key.
2. Press the **DC OFFSET** key, enter "0", and press **mV** key.
3. Press the **AMPTD** key, enter "200", and press **mV** key.
4. Connect a BNC cable from the **SIGNAL** output to the HP 5372A Channel A input pod.
5. Connect a BNC cable from the rear panel **EXT REF IN** to the HP 5372A rear panel **FREQUENCY STANDARD OUTPUT**.

### HP 8663A SETUP

1. Press the **FREQUENCY** key, enter "200", and press **MHz** key.
2. Press the **AMPLITUDE** key, enter "71", and press **mV** key.

### AUTO TRIGGER TEST PROCEDURE

1. Press **Recall** key, and then enter "8" on the **DATA ENTRY** numeric keypad.
2. The HP 5372A CRT should display maximum and minimum results for Channel A. Enter these values on the Performance Test Record.
3. Disconnect the BNC cable from the HP 5372A Channel A input pod and connect it to the HP 5372A Channel B input pod.
4. Press **Recall** key, and then enter "9" on the **DATA ENTRY** numeric keypad.

5. The HP 5372A CRT should display maximum and minimum results for Channel B. Enter these values on the Performance Test Record.
6. Press the HP 3325A AMPTD key, enter "2", and press VOLT key.
7. Press the HP 3325A DC OFFSET key, enter "1", and press VOLT key.
8. Press HP 5372A Restart key.
9. The HP 5372A CRT should display results for Channel B. Enter these values on the Performance Test Record.
10. Press the HP 3325A DC OFFSET key, enter "-1", and press VOLT key.
11. Press HP 5372A Restart key.
12. The HP 5372A CRT should display results for Channel B. Enter these values on the Performance Test Record.
13. Disconnect the BNC cable from the HP 5372A Channel B input pod and connect it to the HP 5372A Channel A input pod.
14. Press Recall key, and then enter "8" on the DATA ENTRY numeric keypad.
15. The HP 5372A CRT should display results for Channel A. Enter these values on the Performance Test Record.
16. Press the HP 3325A DC OFFSET key, enter "1", and press VOLT key.
17. Press HP 5372A Restart key.
18. The HP 5372A CRT should display results for Channel A. Enter these values on the Performance Test Record.
19. Disconnect the BNC cable end from the HP 3325A SIGNAL output, and connect it to the HP 8663A RF OUTPUT.
20. Disconnect the BNC cable end from the HP 3325A rear panel EXT REF IN, and connect it to the HP 8663A rear panel time base input.

21. Press HP 5372A Restart key.
22. The HP 5372A CRT should display results for Channel A. Enter these value on the Performance Test Record.
23. Disconnect the BNC cable from the HP 5372A Channel A input pod and connect it to the HP 5372A Channel B input pod.
24. Press Recall key, and then enter "9" on the DATA ENTRY numeric keypad.
25. The HP 5372A CRT should display results for Channel B. Enter these values on the Performance Test Record.
26. Press the HP 8663A AMPLITUDE key, enter "10", and press +dBm key (The +10 dBm amplitude is equivalent to 2 Vp-p).
27. Press HP 5372A Restart key.
28. The HP 5372A CRT should display results for Channel B. Enter these values on the Performance Test Record.
29. Disconnect the BNC cable from the HP 5372A Channel B input pod and connect it to the HP 5372A Channel A input pod.
30. Press Recall key, and then enter "8" on the DATA ENTRY numeric keypad.
31. The HP 5372A CRT should display results for Channel A. Enter these values on the Performance Test Record.

**Channel A and B  
Sensitivity  
and Minimum Pulse  
Width Test (optional)**

**NOTE**

*The Sensitivity and Minimum Pulse Width Test is an optional performance test. This test requires a 1 ns pulse generator, which is not required equipment.*

---

**Specifications Tested:**

- 45 mV p-p at minimum pulse width
- 1 ns at minimum amplitude
- 1.5 ns at minimum amp. (Holdoff Arm.)

**HP 8131A SETUP**

1. Press the AUTO/TRIG/GATE key, until the **AUTO LED** is ON.
2. Press the Channel 1 DOUB/DELAY key until both the **DELAY LED** and key LED are ON.
3. Use the vernier keys to input "0 ps".
4. Press the Channel 1 DCYC/WIDTH key until both the **DCYC LED** and key LED are ON.
5. Use the vernier keys to input "1%".
6. Press the Channel 1 DCYC/WIDTH key until both the **WIDTH LED** and key LED are ON.
7. Use the vernier keys to input "1.00 ns".
8. Press the Channel 1 AMPL/HIGH key until both the **AMPL LED** and key LED are ON.
9. Use the vernier keys to input ".45 V".
10. Press the Channel 1 OFFS/LOW key until both the **OFFS LED** and key LED are ON.
11. Use the vernier keys to input "0 V".
12. Press the COUNT/PERIOD key until both the **PERIOD LED** and key LED are ON.
13. Use the vernier keys to input "100 ns".
14. Enable the Channel A output by ensuring the **DISABLE**, **LIMIT**, and **COMP LED**s are off.



15. Connect an SMA cable from the Channel 1 OUTPUT to the HP 8495D Attenuator (set at 0 dB attenuation).
16. Connect an SMA(m)-to-BNC(f) adapter to the HP 8495D output.
17. Connect a BNC cable from the HP 8495D to the HP 5372A Channel A input pod.
18. Connect an SMA(m)-to-BNC(f) adapter to the HP 8131A EXT INPUT.
19. Connect a BNC cable from the HP 8131A EXT INPUT to the HP 5372A FREQUENCY STANDARD OUTPUT.
20. Press the AUTO/TRIG/GATE key until the TRIG LED is ON.
21. Press the Positive Slope EXT INPUT key until the key LED is ON.

#### HP 5372A SETUP

1. Press Preset key.
2. Press the **± Time Interval** softkey.
3. Press Input key.
4. Press the **Common** softkey.
5. Move the cursor to the Channel A "Mode" field.
6. Press the **Manual Trig** softkey.
7. Move the cursor to the Channel B "Mode" field.
8. Press the **Manual Trig** softkey.
9. Press Single/Rept key. The SINGLE LED should now be illuminated.
10. Press Math key.
11. Press the **On** softkey (enables Channel A statistics).
12. Press Restart key.
13. Press the **Set Ch A Reference** softkey.

14. Press Input key.
15. Move the cursor to the Channel B "Slope" field.
16. Press the **Neg** softkey.

#### SENSITIVITY AND MINIMUM PULSE WIDTH TEST PROCEDURE

1. Set the HP 8495D to 20 dB attenuation.
2. Press HP 5372A Restart key.
3. The top of the HP 5372A CRT should display a  $\pm$  Time Interval A $\rightarrow$ B result. Enter the absolute value of this result on the Performance Test Record.
4. Press the HP 8131A Channel 1 DCYC/WIDTH key until both the **WIDTH LED** and key LED are ON.
5. Use the vernier keys to input "1.50 ns".
6. Press Function key.
7. Move the cursor to the "Arming Mode" field.
8. Press the **Edge Holdoff** softkey.
9. Move the cursor to the Block Holdoff "edge" field.
10. Press the **Neg** softkey.
11. The top of the HP 5372A CRT should display a  $\pm$  Time Interval A $\rightarrow$ B result. Enter the absolute value of this result on the Performance Test Record.

## EXTERNAL ARM INPUT TESTS

### HP 5372A Configuration Setup

#### NOTE

---

*This procedure sets the HP 5372A Function and Input menus to specific configurations which will be used in the External Arm Input Tests. The configurations are stored in memory using the Save key, and are then recalled from memory during the Performance Tests using the Recall key.*

---

1. Press Preset key.
2. Press the **Frequency** softkey.
3. Move the cursor to the "meas" field.
4. Press "2" on the DATA ENTRY numeric keypad, and then press the Enter key.
5. Move the cursor to the "Arming Mode" field.
6. Press the top softkey until **Hld/Samp** is highlighted.
7. Press the **Edge/Edge** softkey.
8. Move the cursor to the Block Holdoff "Channel" field.
9. Press the **Ext Arm** softkey.
10. Move the cursor to the Sample Arm "Channel" field.
11. Press the **Ext Arm** softkey.
12. Press Numeric key.
13. Press the **Expand** softkey until **On** is highlighted.
14. Press Single/Repet key. The SINGLE LED should now be illuminated.
15. Press Save key, and then enter "1" on the DATA ENTRY numeric keypad.
16. Press Input key.

17. Move the cursor to the Ext Arm "Level" field.
18. Press "2.5" on the DATA ENTRY numeric keypad, and then press the Enter key.
19. Press Save key, and then enter "2" on the DATA ENTRY numeric keypad.
20. Press "-2.5" on the DATA ENTRY numeric keypad, and then press the Enter key.
21. Press Save key, and then enter "3" on the DATA ENTRY numeric keypad.
22. Press "100" on the DATA ENTRY numeric keypad, and then press the **mV** softkey.
23. Press Function key.
24. Move the cursor to the "Arming Mode" field.
25. Press the top softkey until **Holdoff** is highlighted.
26. Press the **Edge Holdoff** softkey.
27. Press Save key, and then enter "4" on the DATA ENTRY numeric keypad.
28. Move the cursor to the Block Holdoff "edge" field.
29. Press the **Neg** softkey.
30. Press Save key, and then enter "5" on the DATA ENTRY numeric keypad.

**NOTE**

---

*The Function and Input menus for each configuration are presented on the following pages. All configurations are in the single mode (SINGLE LED illuminated).*

---

HP 5372A Frequency and Time Interval Analyzer

Waiting for arming...

Frequency A: Chan A

FUNCTION \_\_\_\_\_

**Frequency** Measurement Channel **A**  
 Acquire **1** block of **2** meas  
 Pre-trigger **Off** Total Meas = 2

**Edge/Edge** Arming Mode \_\_\_\_\_

Block Holdoff:  
 After **Pos** edge of **Ext Arm**,  
 Arm a block of measurements

Sample Arm:  
 Arm sampling on meas channel after  
**Pos** edge of **Ext Arm**

HP 5372A Frequency and Time Interval Analyzer

Waiting for arming...

Frequency A: Separate

INPUT \_\_\_\_\_

**Separate** Input Channels Common

Trigger Event:

	Slope	Mode	Level	
Chan A:	<b>Pos</b>	<b>Sgl Auto</b>	<b>50 %</b>	= 2 mV
Chan B:	<b>Pos</b>	<b>Sgl Auto</b>	<b>50 %</b>	= 0 V
Chan C:	<b>POS</b>	<b>MANUAL</b>	<b>0 V</b>	
Ext Arm Level	<b>0 V</b>			

	Channel A	Channel B	Channel C
Input Pod	HP 54002A	HP 54002A	----
Impedance	50 $\Omega$	50 $\Omega$	50 $\Omega$
Bias Level	<b>GND</b>	<b>GND</b>	GND
Attenuation	<b>1:1</b>	<b>1:1</b>	<b>0 %</b>
Hysteresis	<b>Min</b>	<b>Min</b>	----
Max Input	2 V peak	2 V peak	+20 dBm

Figure 17-12. External Arm Input Configuration 1

HP 5372A Frequency and Time Interval Analyzer

Waiting for arming...

Frequency A: Chan A

FUNCTION \_\_\_\_\_

**Frequency** Measurement Channel **A**  
 Acquire **1** block of **2** meas  
 Pre-trigger **Off** Total Meas = 2

**Edge/Edge** Arming Mode \_\_\_\_\_

Block Holdoff:  
 After **Pos** edge of **Ext Arm**,  
 Arm a block of measurements

Sample Arm:  
 Arm sampling on meas channel after  
**Pos** edge of **Ext Arm**

HP 5372A Frequency and Time Interval Analyzer

Waiting for arming...

Frequency A: 0 V

INPUT \_\_\_\_\_

**Separate** Input Channels TTL Preset [ 1.4 V]

Trigger Event:

	Slope	Mode	Level	
Chan A:	<b>Pos</b>	<b>Sgl Auto</b>	<b>50 %</b>	= 2 mV
Chan B:	<b>Pos</b>	<b>Sgl Auto</b>	<b>50 %</b>	= 0 V
Chan C:	<b>POS</b>	<b>MANUAL</b>	<b>0 V</b>	
Ext Arm Level	<b>2.50 V</b>			

	Channel A	Channel B	Channel C
Input Pod	HP 54002A	HP 54002A	----
Impedance	50 $\Omega$	50 $\Omega$	50 $\Omega$
Bias Level	<b>GND</b>	<b>GND</b>	GND
Attenuation	<b>1:1</b>	<b>1:1</b>	<b>0 %</b>
Hysteresis	<b>Min</b>	<b>Min</b>	----
Max Input	2 V peak	2 V peak	+20 dBm

Figure 17-13. External Arm Input Configuration 2

HP 5372A Frequency and Time Interval Analyzer

Waiting for arming...  
 Frequency A: \_\_\_\_\_  
 Chan A \_\_\_\_\_  
 Chan B \_\_\_\_\_  
 Ext Arm \_\_\_\_\_

FUNCTION \_\_\_\_\_  
**Frequency** \_\_\_\_\_ Measurement Channel **A**  
 Acquire **1** block of **2** meas  
 Pre-trigger **Off** Total Meas = 2

**Edge/Edge** \_\_\_\_\_ Arming Mode \_\_\_\_\_  
 Block Holdoff:  
 After **Pos** edge of **Ext Arm**,  
 Arm a block of measurements

Sample Arm: \_\_\_\_\_  
 Arm sampling on meas channel after  
**Pos** edge of **Ext Arm**

HP 5372A Frequency and Time Interval Analyzer

Waiting for arming...  
 Frequency A: \_\_\_\_\_  
 Chan A \_\_\_\_\_  
 Chan B \_\_\_\_\_  
 Ext Arm \_\_\_\_\_

INPUT \_\_\_\_\_  
**Separate** Input Channels  
 Trigger Event: \_\_\_\_\_  
 Slope Mode Level  
 Chan A: **Pos Sgl Auto 50 %** = 2 mV  
 Chan B: **Pos Sgl Auto 50 %** = 0 V  
 Chan C: **POS MANUAL 0 V**  
 Ext Arm Level **-2.50 V**

TTL Preset [ 1.4 V]  
 ECL Preset [-1.3 V]

	Channel A	Channel B	Channel C
Input Pod	HP 54002A	HP 54002A	-----
Impedance	50 $\Omega$	50 $\Omega$	50 $\Omega$
Bias Level	<b>GND</b>	<b>GND</b>	GND
Attenuation	<b>1:1</b>	<b>1:1</b>	<b>0 %</b>
Hysteresis	<b>Min</b>	<b>Min</b>	-----
Max Input	2 V peak	2 V peak	+20 dBm

Figure 17-14. External Arm Input Configuration 3

HP 5372A Frequency and Time Interval Analyzer

Waiting for arming...  
 Frequency A: \_\_\_\_\_  
 Chan A \_\_\_\_\_  
 Chan B \_\_\_\_\_  
 Ext Arm \_\_\_\_\_

FUNCTION \_\_\_\_\_  
**Frequency** \_\_\_\_\_ Measurement Channel **A**  
 Acquire **1** block of **2** meas  
 Pre-trigger **Off** Total Meas = 2

**Edge Holdoff** \_\_\_\_\_ Arming Mode \_\_\_\_\_  
 Block Holdoff:  
 After **Pos** edge of **Ext Arm**,  
 Arm a block of measurements

Sample Arm: \_\_\_\_\_  
 Arm sampling on meas channel automatically

Default [Auto]

HP 5372A Frequency and Time Interval Analyzer

Waiting for arming...  
 Frequency A: \_\_\_\_\_  
 Chan A \_\_\_\_\_  
 Chan B \_\_\_\_\_  
 Ext Arm \_\_\_\_\_

INPUT \_\_\_\_\_  
**Separate** Input Channels  
 Trigger Event: \_\_\_\_\_  
 Slope Mode Level  
 Chan A: **Pos Sgl Auto 50 %** = 2 mV  
 Chan B: **Pos Sgl Auto 50 %** = 0 V  
 Chan C: **POS MANUAL 0 V**  
 Ext Arm Level **100 mV**

TTL Preset [ 1.4 V]  
 ECL Preset [-1.3 V]

	Channel A	Channel B	Channel C
Input Pod	HP 54002A	HP 54002A	-----
Impedance	50 $\Omega$	50 $\Omega$	50 $\Omega$
Bias Level	<b>GND</b>	<b>GND</b>	GND
Attenuation	<b>1:1</b>	<b>1:1</b>	<b>0 %</b>
Hysteresis	<b>Min</b>	<b>Min</b>	-----
Max Input	2 V peak	2 V peak	+20 dBm

Figure 17-15. External Arm Input Configuration 4

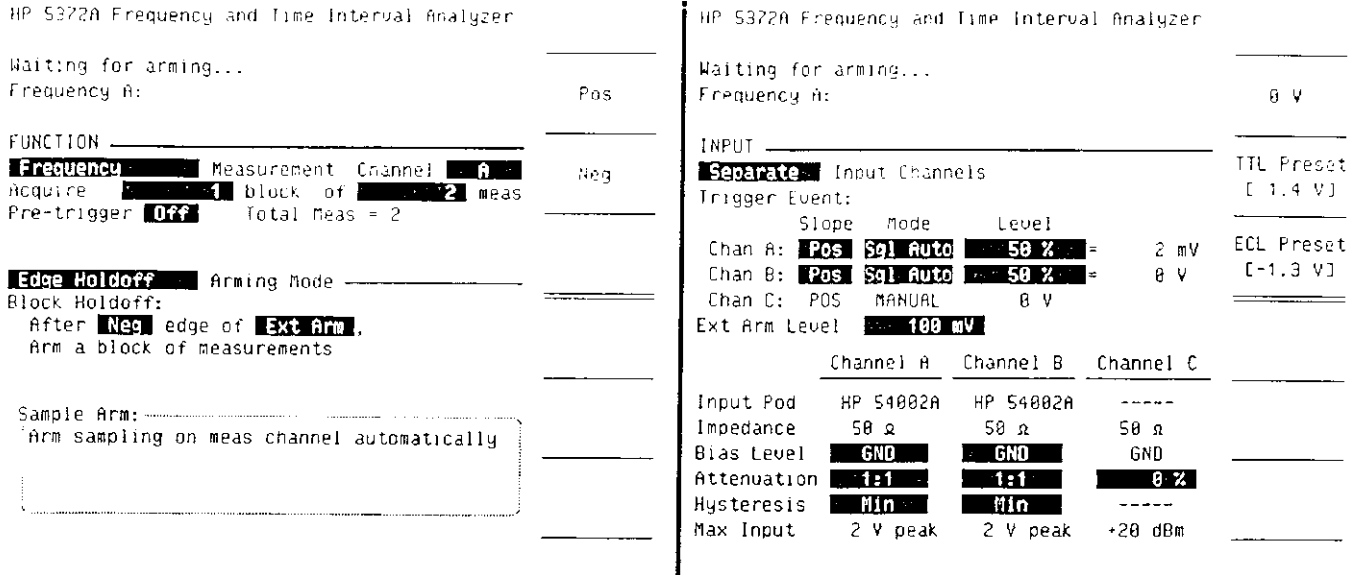

Figure 17-16. External Arm Input Configuration 5

**NOTE**

The rear panel External Arm Input specifications (option 060 and 090) are different than the front panel specifications. The complete front-panel performance tests are listed first, followed by the complete rear-panel performance tests.

**Front Panel External Arm Input Tests**

**Specifications Tested:**

- DC to 100 MHz Frequency Range
- 140 mV p-p to 5 Vp-p Dynamic Range
- 5 V to +5 V Signal Operating Range
- $\pm 20$  mV or  $\pm 10\%$  of setting Trigger Accuracy
- 140 mV p-p Sensitivity at min pulse width
- 5 ns Minimum Pulse Width at min amplitude

**Equipment:**

- HP 3325B Synthesizer/Function Generator
- HP 8663A Synthesized Signal Generator
- HP 8161A Pulse Generator

**Description:** The External Arm Input Tests consists of four separate test procedures, which verify the above specifications. The first test verifies both the frequency range and dynamic range, the second test verifies the signal operating range, the third test verifies the trigger accuracy, and the fourth test verifies both the sensitivity and minimum pulse width.

**External Arm Input  
Frequency and  
Dynamic Ranges Test**

**Specifications Tested:**

DC to 100 MHz  
140 mVp-p to 5 Vp-p

**NOTE**

---

*The low frequency range (DC) specification is tested in the trigger accuracy test.*

---

**HP 5372A SETUP**

1. Connect a 50 ohm feedthrough termination to the External Arm input.
2. Connect a BNC T-connector to the rear-panel FREQUENCY STANDARD OUTPUT.
3. Connect a BNC cable from one end of the T-connector to the Channel A input pod.

**HP 3325A SETUP**

1. Press the FREQ key, enter "1", and press Hz key.
2. Press the DC OFFSET key, enter "0", and press mV key.
3. Press the AMPTD key, enter "140", and press mV key.
4. Select the sine wave (20 MHz) function.
5. Connect a BNC cable from the SIGNAL output to the HP 5372A External Arm input.
6. Connect a BNC cable from the rear panel EXT REF IN to the HP 5372A rear panel FREQUENCY STANDARD OUTPUT (the HP 3325A front-panel EXT REF LED should be illuminated).



### HP 8663A SETUP

1. Press the FREQUENCY key, enter "100", and press MHz key.
2. Press the AMPLITUDE key, enter "50", and press mV key.
3. Attach a N(m)-to-BNC(f) adapter (HP # 1250-0780) to the RF OUTPUT connector.

### FREQUENCY RANGE AND DYNAMIC RANGE TEST PROCEDURE

1. Press Recall key, and then enter "1" on the DATA ENTRY numeric keypad.
2. Press Numeric key.
3. Move the cursor to the "View Meas #" field.
4. Press "3" on the DATA ENTRY numeric keypad, and then press the Enter key.
5. The HP 5372A CRT should display both a frequency result and a gate time for Channel A. Record the gate time on the Performance Test Record.
6. Press the HP 3325A AMPTD key, enter "5", and press VOLT key.
7. Press the HP 3325A square wave (10 MHz) function key.
8. Press HP 5372A Restart key.
9. The HP 5372A CRT should display both a frequency result and a gate time for Channel A. Record the gate time on the Performance Test Record.
10. Disconnect the BNC cable end from the HP 3325A SIGNAL output, and connect it to the HP 8663A RF OUTPUT.
11. Disconnect the BNC cable end from the HP 3325A rear panel EXT REF IN, and connect it to the HP 8663A rear panel time base input.
12. Press Restart key.

13. The HP 5372A CRT should display both a frequency result and a gate time for Channel A. Record the gate time on the Performance Test Record.

**External Arm Input  
Signal Operating  
Range Test**

**Specification Tested:**

-5 Vdc to +5 Vdc

**HP 3325A SETUP**

1. Press the **FREQ** key, enter "10", and press **MHz** key.
2. Press the **AMPTD** key, enter "5", and press **VOLT** key.
3. Press the **DC OFFSET** key, enter "2.5", and press **VOLT** key.
4. Select the sine wave (20 MHz) function.
5. Connect a BNC cable from the **SIGNAL** output to the HP 5372A External Arm input.
6. Connect a BNC cable from the rear panel **EXT REF IN** to the HP 5372A rear panel **FREQUENCY STANDARD OUTPUT**.

**SIGNAL OPERATING RANGE TEST PROCEDURE**

1. Press **Recall** key, and then enter "2" on the **DATA ENTRY** numeric keypad.
2. The HP 5372A CRT should display both a frequency result and a gate time for Channel A. Record the gate time on the Performance Test Record.
3. Press the HP 3325A **DC OFFSET** key, enter "-2.5", and press **VOLT** key.
4. Press **Recall** key, and then enter "3" on the **DATA ENTRY** numeric keypad.
5. The HP 5372A CRT should display both a frequency result and a gate time for Channel A. Record the gate time on the Performance Test Record.

**External Arm Input  
Trigger Accuracy Test**

**Specifications Tested:**

$\pm 20$  mV or 10% of setting, whichever is greater.

**NOTE**

---

*This test also verifies the low frequency range (DC) specification.*

---

**HP 3458A SETUP**

1. Connect a Banana-to-BNC adapter to the 2 wire input.

**HP 3325A SETUP**

1. Press the sine wave (20 MHz) function (enables the DC only mode).
2. Press the DC OFFSET key, enter "80, and press mV key.
3. Connect a BNC T-connector to the SIGNAL output.
4. Connect a BNC cable from one end of the T-connector to the HP 5372A External Arm input.
5. Connect a BNC cable from one end of the T-connector to the HP 3458A Multimeter.
6. Connect a BNC cable from the rear panel EXT REF IN to the HP 5372A rear panel FREQUENCY STANDARD OUTPUT.

**TRIGGER ACCURACY TEST PROCEDURE**

1. Press Recall key, and then enter "4" on the DATA ENTRY numeric keypad.
2. Using the HP 3325A MODIFY keys, increase the DC OFFSET in 1 mV increments until the GATE LED goes off. Record the DC OFFSET value, from the HP 3458A display, on the Performance Test Record.
3. Press the HP 3325A DC OFFSET key, enter "120", and press mV key.
4. Press Recall key, and then enter "5" on the DATA ENTRY numeric keypad.

5. Using the HP 3325A MODIFY keys, decrease the DC OFFSET in 1 mV increments until the GATE LED goes off. Record the DC OFFSET value, from the HP 3458A display, on the Performance Test Record.
6. Calculate the average of the two recorded DC OFFSET values, and then subtract 100 mV (HP 5372A Ext Arm trigger level) from the average. Record this result on the Performance Test Record.

**External Arm Input  
Sensitivity and  
Minimum Pulse  
Width Test**

**Specifications Tested:**

- 140 mVp-p at minimum amplitude
- 5 ns at minimum amplitude

**HP 8161A SETUP**

1. Press the PERIOD key, enter "200" on the CHANNEL/DATA keys, and then press ns key.
2. Press the DELAY key, press CHANNEL A key, enter "0" on the CHANNEL/DATA keys, then press ns key.
3. Press the WIDTH key, press CHANNEL A key, enter "5" on the CHANNEL/DATA keys, and then press ns key.
4. Press the LEE key, press CHANNEL A key, enter "1.3" on the CHANNEL/DATA keys, and then press ns key.
5. Press the TRE key, press CHANNEL A key, enter "1.3" on the CHANNEL/DATA keys, and then press ns key.
6. Press the HIL key, press CHANNEL A key, enter ".07" on the CHANNEL/DATA keys, and then press V key.
7. Press the LOL key, press CHANNEL A key, enter "-.07" on the CHANNEL/DATA keys, and then press V key.
8. Enable the Channel A output by ensuring the DISABLE LED is off.
9. Connect a BNC cable from OUTPUT A to the HP 5372A External Arm Input.

**SENSITIVITY AND MINIMUM  
PULSE WIDTH TEST PROCEDURE**

1. Press Recall key, and then enter "1" on the DATA ENTRY numeric keypad.
2. The HP 5372A CRT should display both a frequency result and a gate time for Channel A. Record the gate time on the Performance Test Record.

**Rear Panel External  
Arm Input Tests**

**Specifications Tested:**

DC to 100 MHz Frequency Range  
280 mV p-p to 5 Vp-p Dynamic Range (DC to 20 MHz)  
280 mV p-p to 2.5 Vp-p Dynamic Range  
(20 MHz to 100 MHz)

-5 V to +5 V Signal Operating Range

± 20 mV or 10% of setting Trigger Accuracy

280 mV p-p Sensitivity at min pulse width  
5 ns Minimum Pulse Width at min amplitude

**Equipment:**

HP 3325B Synthesizer/Function Generator  
HP 8663A Synthesized Signal Generator  
HP 8161A Pulse Generator

**Description:** The External Arm Input Tests consists of four separate test procedures, which verify the above specifications. The first test verifies both the frequency range and dynamic range, the second test verifies the signal operating range, the third verifies the trigger accuracy, and the fourth test verifies both the sensitivity and minimum pulse width.

**Rear Panel  
External Arm Input  
Frequency and  
Dynamic Ranges Test**

**Specifications Tested:**

DC to 100 MHz  
280 mVp-p to 5 Vp-p (DC to 20 MHz)  
280 mVp-p to 2.5 Vp-p (20 MHz to 100 MHz)

**NOTE**

*The low frequency range (DC) specification is tested in the trigger accuracy test.*

---

**HP 5372A SETUP**

1. Connect a 50 ohm feedthrough termination to the External Arm input.
2. Connect a T-connector to the rear-panel FREQUENCY STANDARD OUTPUT.
3. Connect a BNC cable from one end of the T-connector to the Channel A input.

**HP 3325A SETUP**

1. Press the **FREQ** key, enter "1", and press **Hz** key.
2. Press the **DC OFFSET** key, enter "0", and press **mV** key.
3. Press the **AMPTD** key, enter "280", and press **mV** key.
4. Select the sine wave (20 MHz) function.
5. Connect a BNC cable from the **SIGNAL** output to the HP 5372A External Arm input.
6. Connect a BNC cable from the rear panel **EXT REF IN** to the HP 5372A rear panel **FREQUENCY STANDARD OUTPUT** (the HP 3325A front-panel **EXT REF LED** should be illuminated).

**HP 8663A SETUP**

1. Press the **FREQUENCY** key, enter "100", and press **MHz** key.
2. Press the **AMPLITUDE** key, enter "100", and press **mV** key.
3. Attach a N(m)-to-BNC(f) adapter (HP # 1250-0780) to the **RF OUTPUT** connector.

## FREQUENCY RANGE AND DYNAMIC RANGE TEST PROCEDURE

1. Press Recall key, and then enter "1" on the DATA ENTRY numeric keypad.
2. Press Numeric key.
3. Move the cursor to the "View Meas #" field.
4. Press "2" on the DATA ENTRY numeric keypad, and then press the Enter key.
5. The HP 5372A CRT should display both a frequency result and a gate time for Channel A. Record the gate time on the Performance Test Record.
6. Press the HP 3325A AMPTD key, enter "5", and press VOLT key.
7. Press the HP 3325A square wave (10 MHz) function key.
8. Press HP 5372A Restart key.
9. The HP 5372A CRT should display both a frequency result and a gate time for Channel A. Record the gate time on the Performance Test Record.
10. Disconnect the BNC cable end from the HP 3325A SIGNAL output, and connect it to the HP 8663A RF OUTPUT.
11. Disconnect the BNC cable end from the HP 3325A rear panel EXT REF IN, and connect it to the HP 8663A rear panel time base input.
12. Press Restart key.
13. The HP 5372A CRT should display both a frequency result and a gate time for Channel A. Record the gate time on the Performance Test Record.

**Rear Panel  
External Arm Input  
Signal Operating  
Range Test**

**Specification Tested:**  
-5 Vdc to +5 Vdc

**HP 3325A SETUP**

1. Press the **FREQ** key, enter "10", and press **MHz** key.
2. Press the **AMPTD** key, enter "5", and press **VOLT** key.
3. Press the **DC OFFSET** key, enter "2.5", and press **VOLT** key.
4. Select the sine wave (20 MHz) function.
5. Connect a BNC cable from the **SIGNAL** output to the HP 5372A External Arm input.
6. Connect a BNC cable from the rear panel **EXT REF IN** to the HP 5372A rear panel **FREQUENCY STANDARD OUTPUT**.

**SIGNAL OPERATING RANGE TEST PROCEDURE**

1. Press **Recall** key, and then enter "2" on the **DATA ENTRY** numeric keypad.
2. The HP 5372A CRT should display both a frequency result and a gate time for Channel A. Record the gate time on the Performance Test Record.
3. Press the HP 3325A **DC OFFSET** key, enter "-2.5", and press **VOLT** key.
4. Press **Recall** key, and then enter "3" on the **DATA ENTRY** numeric keypad.
5. The HP 5372A CRT should display both a frequency result and a gate time for Channel A. Record the gate time on the Performance Test Record.



**Rear Panel  
External Arm Input  
Trigger Accuracy Test**

**Specifications Tested:**

$\pm 20$  mV or 10% of setting, whichever is greater.

**NOTE**

---

*This test also verifies the low frequency range (DC) specification.*

---

**HP 3458A SETUP**

1. Connect a Banana-to-BNC adapter to the 2 wire input.

**HP 3325A SETUP**

1. Press the sine wave (20 MHz) function (enables the DC only mode).
2. Press the DC OFFSET key, enter "80", and press mV key.
3. Connect a BNC T-connector to the SIGNAL output.
4. Connect a BNC cable from one end of the T-connector to the HP 5372A External Arm input.
5. Connect a BNC cable from one end of the T-connector to the HP 3458A Multimeter.
6. Connect a BNC cable from the rear panel EXT REF IN to the HP 5372A rear panel FREQUENCY STANDARD OUTPUT.

**TRIGGER ACCURACY TEST PROCEDURE**

1. Press Recall key, and then enter "4" on the DATA ENTRY numeric keypad.
2. Using the HP 3325A MODIFY keys, increase the DC OFFSET in 1 mV increments until the GATE LED goes off. Record the DC OFFSET value, from the HP 3458A display, on the Performance Test Record.
3. Press the HP 3325A DC OFFSET key, enter "120", and press mV key.
4. Press Recall key, and then enter "5" on the DATA ENTRY numeric keypad.

5. Using the HP 3325A MODIFY keys, decrease the DC OFFSET in 1 mV increments until the GATE LED goes off. Record the DC OFFSET value, from the HP 3458A display, on the Performance Test Record.
6. Calculate the average of the two recorded DC OFFSET values, and then subtract 100 mV (HP 5372A Ext Arm trigger level) from the average. Record this result on the Performance Test Record.

**Rear Panel  
External Arm Input  
Sensitivity and  
Minimum Pulse  
Width Test**

**Specifications Tested:**

280 mVp-p at minimum amplitude  
5 ns at minimum amplitude

**HP 8161A SETUP**

1. Press the PERIOD key, enter "200" on the CHANNEL/DATA keys, and then press ns key.
2. Press the DELAY key, press CHANNEL A key, enter "0" on the CHANNEL/DATA keys, and then press ns key.
3. Press the WIDTH key, press CHANNEL A key, enter "5" on the CHANNEL/DATA keys, and then press ns key.
4. Press the LEE key, press CHANNEL A key, enter "1.3" on the CHANNEL/DATA keys, and then press ns key.
5. Press the TRE key, press CHANNEL A key, enter "1.3" on the CHANNEL/DATA keys, and then press ns key.
6. Press the HIL key, press CHANNEL A key, enter ".14" on the CHANNEL/DATA keys, and then press V key.
7. Press the LOL key, press CHANNEL A key, enter "-.14" on the CHANNEL/DATA keys, and then press V key.
8. Enable the Channel A output by ensuring the DISABLE LED is off.
9. Connect a BNC cable from OUTPUT A to the HP 5372A External Arm Input.

## SENSITIVITY AND MINIMUM PULSE WIDTH TEST PROCEDURE

1. Press Recall key, and then enter "1" on the DATA ENTRY numeric keypad.
2. The HP 5372A CRT should display both a frequency result and a gate time for Channel A. Record the gate time on the Performance Test Record.

## CHANNEL C TESTS

### Specifications Tested:

100 MHz to 2.0 GHz Frequency Range  
-25 dBm to 7 dBm Dynamic Range  
-25 dBm Sensitivity

### Equipment:

HP 8663A Synthesized Signal Generator  
HP 436A Power Meter  
HP 8481A Power Sensor  
HP 11667A Power Splitter  
2 HP 1250-1250 N(m)-to-SMA(f) Adapters  
2 HP 1250-0778 N(m)-to-N(m) Adapters  
SMC cable (Gore SN 56181)

**Description:** The Channel C Tests consists of one test procedure, which verifies the above specifications. This test procedure is for the option 030 or 090 2 GHz C-Channel.

### **NOTE**

*Perform the calibration procedures on the HP 436A.*

## HP 5372A Configuration Setup

1. Press Preset key.
2. Press **F**requency softkey.
3. Move the cursor to the "Channel" field.
4. Press the **M**ore softkey until C is a menu selection option.
5. Press the **C** softkey.

6. Move the cursor to the "meas" field.
7. Press "1" on the DATA ENTRY numeric keypad, and then press the Enter key.
8. Move the cursor to the "Arming Mode" field.
9. Press the top softkey until **Sample** is highlighted.
10. Press the **Interval Sampling** softkey.
11. Move the cursor to the Sample Arm "intervals" field.
12. Press "1" on the DATA ENTRY numeric keypad, and then press the Enter key.
13. Press Single/Repet key. The SINGLE LED should now be illuminated.

HP 5372A Frequency and Time Interval Analyzer

Waiting for input signal...

Frequency C:

FUNCTION

**Frequency** Measurement Channel **C**  
 Acquire **1** block of **1** meas  
 Pre-trigger **Off** Total Meas = 1

**Interval Sampling** Arming Mode

Block Holdoff:  
 Arm a block of measurements automatically

Sample Arm:

Arm sampling on meas channel after  
**1.0000000 s** intervals

Acquisition Time/Block \* 1.0000 s

HP 5372A Frequency and Time Interval Analyzer

Waiting for input signal...

Frequency C:

Separate

INPUT

**Separate** Input Channels

Common

Trigger Event:

	Slope	Mode	Level	
Chan A:	<b>Pos</b>	<b>SqI Auto</b>	<b>50 %</b>	= 2 mV
Chan B:	<b>Pos</b>	<b>SqI Auto</b>	<b>50 %</b>	= 0 V
Chan C:	<b>POS</b>	<b>MANUAL</b>	<b>0 V</b>	
Ext Arm Level			<b>0 V</b>	

	Channel A	Channel B	Channel C
Input Pod	HP 54002A	HP 54002A	----
Impedance	50 $\Omega$	50 $\Omega$	50 $\Omega$
Bias Level	<b>GND</b>	<b>GND</b>	GND
Attenuation	<b>1:1</b>	<b>1:1</b>	<b>0 %</b>
Hysteresis	<b>Min</b>	<b>Min</b>	----
Max Input	2 V peak	2 V peak	+20 dBm

Figure 17-17. Channel C Configuration

## Frequency Range/ Dynamic Range/ Sensitivity Test

### HP 5372A SETUP

1. Set up the HP 5372A as shown in Figure 17-18.

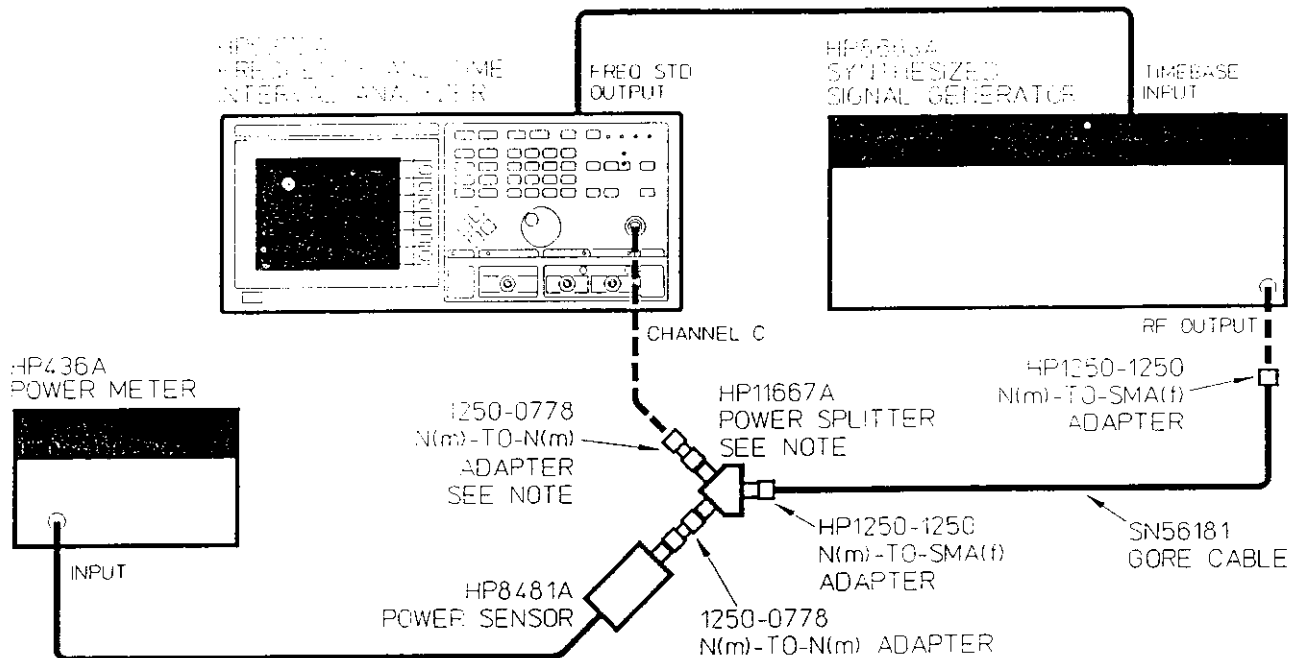

NOTE: CONNECT THE N(m)-TO-N(m) ADAPTER AND POWER SPLITTER DIRECTLY TO THE CHANNEL C INPUT. DO NOT USE A CABLE EXTENSION.

1501.NM

Figure 17-18. Channel C Test Setup

### HP 8663A SETUP

1. Press the FREQUENCY key, enter "100", and press MHz key.
2. Press the AMPLITUDE key, enter "25", and press -dBm key.

### FREQUENCY RANGE/DYNAMIC RANGE/SENSITIVITY TEST PROCEDURE

1. Adjust the HP 8663A amplitude until the HP 436A display reads -25 dBm.
2. Press HP 5372A Numeric key.

3. Press HP 5372A Restart key.
4. The HP 5372A CRT should display a result for Channel C. Enter this value on the Performance Test Record.
5. Adjust the HP 8663A amplitude until the HP 436A display reads +7 dBm.
6. Press HP 5372A Restart key.
7. The HP 5372A CRT should display a result for Channel C. Enter this value on the Performance Test Record.
8. Recalibrate the HP 436A Power Meter with a calibration factor of 99%.
9. Press the HP 8663A FREQUENCY key, enter "1.5", and press GHz key.
10. Adjust the HP 8663A amplitude until the HP 436A display reads -25 dBm.
11. Press HP 5372A Restart key.
12. The HP 5372A CRT should display a result for Channel C. Enter this value on the Performance Test Record.
13. Adjust the HP 8663A amplitude until the HP 436A display reads +7 dBm.
14. Press HP 5372A Restart key.
15. The HP 5372A CRT should display a result for Channel C. Enter this value on the Performance Test Record.
16. Press the HP 8663A FREQUENCY key, enter "1.55", and press GHz key.
17. Adjust the HP 8663A amplitude until the HP 436A display reads -20 dBm.
18. Press HP 5372A Restart key.
19. The HP 5372A CRT should display a result for Channel C. Enter this value on the Performance Test Record.
20. Adjust the HP 8663A amplitude until the HP 436A display reads +7 dBm.

21. Press HP 5372A Restart key.
22. The HP 5372A CRT should display a result for Channel C. Enter this value on the Performance Test Record.
23. Recalibrate the HP 436A Power Meter with a calibration factor of 98%.
24. Press the HP 8663A FREQUENCY key, enter "2.0", and press GHz key.
25. Adjust the HP 8663A amplitude until the HP 436A display reads -20 dBm.
26. Press HP 5372A Restart key.
27. The HP 5372A CRT should display a result for Channel C. Enter this value on the Performance Test Record.
28. Adjust the HP 8663A amplitude until the HP 436A display reads +7 dBm.
29. Press HP 5372A Restart key.
30. The HP 5372A CRT should display a result for Channel C. Enter this value on the Performance Test Record.

THE HP 5372A PERFORMANCE TESTS ARE NOW COMPLETE.

## HP-IB VERIFICATION PROGRAM

The HP-IB Operation Verification Program checks the HP 5372's ability to transmit and receive HP-IB messages. During this verification program, the analyzer's HP-IB data input/output bus, control, and handshake lines are checked. Only the HP 5372A, an HP Series 200 or 300 Computer, and applicable HP-IB interface cable are required for the test setup. The validity of the test results is based on the following assumptions:

- The HP 5372A operates correctly from the front panel. This can be verified by performing the "HP 5372A Operation Verification Tests" found earlier in this chapter.
- The controller being used can properly execute HP-IB commands.

The HP 5372A's device address (primary address) is 03 and may be changed from the front panel through the System menu. The address setting applies to both the Talk/Listen and Talk Only modes. For the HP Series 200 or 300 Computers the HP-IB interface select code is 7.

### **NOTE**

---

*The device address is retained in non-volatile memory. If the address is not recallable due to a battery or memory failure, a default value of 3 will be selected. The user can not alter the default address.*

---

If all of the checks performed by the program listed in *Table 17-3* are successful, the HP 5372A's HP-IB capability can be considered to be performing properly. This program does not check to see if ALL of the analyzer's program commands are being properly interpreted and executed by the HP 5372A. However, if the front panel operation is confirmed to be working properly and its HP-IB capability operates correctly, then there is high probability that the analyzer will respond properly to all of its program commands.

After successful completion of the HP-IB Operation Verification Test presented in *Table 17-3*, mark "PASS" or "FAIL" on the "HP 5372A Performance Test Record" located at the end of this chapter.

THE HP 5372A HP-IB OPERATION VERIFICATION IS NOW COMPLETE.



Table 17-3. HP-IB Operation Verification Program

```

10  !!!!!!!!!!!!!!!!!!!!!!!!!!!!!!!!!!!!!!!!!!!!!!!!!!!!!!!!!!!!!!!!!!!!!!!
20  !                               "VERI72A                               !
30  !                               hp-ib verification program           9/15/89 B.K. !
40  !                               !                               !
50  ! Connect the 5372A to a series 200/300 computer with BASIC loaded. !
60  ! Load and run this program to verify operation of the bus.       !
70  !                               !                               !
80  !!!!!!!!!!!!!!!!!!!!!!!!!!!!!!!!!!!!!!!!!!!!!!!!!!!!!!!!!!!!!!!!!!!!!!!
90  OUTPUT 2;"*K";END
100 CLEAR SCREEN
110 PRINT "HP 5372A FREQUENCY AND TIME INTERVAL ANALYZER HP-IB FUNCTIONS TEST
PROGRAM"
120 PRINT "REVISION A.00.00  DATE: 19 SEP 1989  BY:BK"
130 PRINT
140 PRINT "This program verifies the operation of the HP 5372A HP-IB."
150 PRINT
160 PRINT "Date of this test: ";DATE$(TIMEDATE)
170 OPTION BASE 1
180 DIM Result$(25)
190 ON TIMEOUT 7,5 GOTO To_long
200 DISP "Turn 5372A power OFF--press continue when done"
210 PAUSE
220 DISP "Connect rear-panel 10MHz output to A channel input--press continue"
230 PAUSE
240 DISP "Turn 5372A power ON, wait until FUNCTION screen is displayed";
250 DISP "--press continue"
260 PAUSE
270 DISP "Select SYSTEM menu, choose Talk/Listen, and set address to 3--press
continue"
280 PAUSE
290 GOSUB Test1 !self test status
300 GOSUB Test2 !bus integrity
310 GOSUB Test3 !status registers
320 GOSUB Test4 !data transfer
330 PRINT "PASSED HP-IB VERIFICATION."
340 DISP " "
350 OUTPUT 703;"DSP, " "PASSED HP-IB VERIFICATION" ";LOC"
360 STOP
370 To_long: !
380 PRINT "HP-IB TIMEOUT, TESTING ABORTED"
390 PRINT "CHECK:"
400 PRINT "      1.CABLES"
410 PRINT "      2.OTHER INSTRUMENTS ON BUS"
420 PRINT "      3.ADDRESS SETTINGS"
430 PRINT "      4.CHECK HP-IB ISC =7  "
440 PRINT "      5.HANDSHAKE SIGNALS WITH BUS ANALYZER"
450 STOP
460 Test1: !!!!!!!!!!!!!!!!!!!!!!!!!!!!!!!!!!!!!!!!!!!!!!!!!!!!!!!!!!!!!!!!!!!!!!!
470 !                               TEST 1                               !
480 !                               self-test status                       !
490 !5372A must pass self test before continuing this verification       !
500 !!!!!!!!!!!!!!!!!!!!!!!!!!!!!!!!!!!!!!!!!!!!!!!!!!!!!!!!!!!!!!!!!!!!!!!
510 Analyzer=703

```

Table 17-3. HP-IB Operation Verification Program (Continued)

```

520 OUTPUT Analyzer;"CLE;PRES"
530 OUTPUT Analyzer;"DSP,""HP-IB VERIFICATION TEST 1""
540 DISP "HP-IB VERIFICATION TEST 1 SELF TEST",
550 OUTPUT Analyzer;"DIAG;TEST,1"
560 DISP " WAIT 20 SECONDS ..."
570 WAIT 20 ! WAIT FOR SELF-TEST TO COMPLETE
580 OUTPUT Analyzer;"TEST?"
590 WAIT .2
600 ENTER Analyzer;Result$
610 IF Result$=" 0 [ ] No new test data" THEN GOTO 580 !Query again,not ready
620 IF Result$<>" 1 {P} Self Test PASSED" THEN ! Self Test FAILED
630 PRINT "TEST 1 FAILED, TEST ABORTED"
640 PRINT "' 1 {P} Self Test PASSED' SHOULD BE RETURNED"
650 PRINT "RESULT IS: ";Result$
660 BEEP
670 STOP
680 END IF
690 PRINT "TEST 1 Self-Test Status : PASSED"
700 OUTPUT Analyzer;"STOP;DSP,""TEST 1 PASSED""
710 BEEP
720 WAIT 1
730 RETURN
740 Test2: !!!!!!!!!!!!!!!!!!!!!!!!!!!!!!!!!!!!!!!!!!!!!!!!!!!!!!!!!!!!!!!!!!!!!!!
750 ! TEST 2 !
760 ! bus integrity !
770 !Ability of the bus to send and receive data is tested. !
780 !!!!!!!!!!!!!!!!!!!!!!!!!!!!!!!!!!!!!!!!!!!!!!!!!!!!!!!!!!!!!!!!!!!!!!!
790 DIM Send$(200)
800 Analyzer=703
810 OUTPUT Analyzer;"CLE;PRES"
820 OUTPUT Analyzer;"MEAS;FUNC FREQ"
830 DISP "HP-IB VERIFICATION TEST 2"
840 OUTPUT Analyzer;"DSP,""HP-IB VERIFICATION TEST 2""
850 WAIT 2
860 FOR Number=40 TO 127
870 Send$="DSP,""&CHR$(Number)&" TESTING"&"""&" ;DSP?"
880 OUTPUT Analyzer;Send$
890 WAIT .2
900 ENTER 703;Result$
910 IF Result$<>CHR$(Number)&" TESTING" THEN
920 PRINT "TEST 2 FAILED, TEST ABORTED"
930 OUTPUT Analyzer;"DSP,""TEST 2 FAILED, TEST ABORTED""
940 PRINT "CHARACTER RETURNED IS ";Result$
950 PRINT "SHOULD BE: ";CHR$(Number)
960 STOP
970 END IF
980 NEXT Number
990 PRINT "TEST 2 Bus Integrity : PASSED"
1000 OUTPUT Analyzer;"DSP,""TEST 2 PASSED""
1010 BEEP
1020 WAIT .2
1030 BEEP
1040 WAIT 1

```

Table 17-3. HP-IB Operation Verification Program (Continued)

```

1050 RETURN
1060 Test3: !!!!!!!!!!!!!!!!!!!!!!!!!!!!!!!!!!!!!!!!!!!!!!!!!!!!!!!!!!!!!!!!!!!!!!!
1070 ! TEST 3 !
1080 ! status registers !
1090 !The operation of the status registers is verified !
1100 !!!!!!!!!!!!!!!!!!!!!!!!!!!!!!!!!!!!!!!!!!!!!!!!!!!!!!!!!!!!!!!!!!!!!!!
1110 INTEGER Value, Twopower
1120 Analyzer=703
1130 OUTPUT Analyzer;"CLE;PRES"
1140 DISP "HP-IB VERIFICATION TEST 3.1"
1150 OUTPUT Analyzer;"DSP,""HP-IB VERIFICATION TEST 3.1""
1160 FOR Value=0 TO 7
1170 Twopower=2^Value
1180 Send$="*ESE,"&VAL$(Twopower)&";*ESE?"
1190 OUTPUT Analyzer;Send$
1200 WAIT .2
1210 ENTER Analyzer;Result
1220 IF Twopower<>Result THEN
1230 PRINT "FAILED TEST 3.1, TEST ABORTED"
1240 OUTPUT Analyzer;"DSP,""FAILED TEST 3.1, TEST ABORTED"
1250 PRINT "RETURNED VALUE OF EVENT STATUS REG IS:"
1260 PRINT Result
1270 PRINT "IT SHOULD BE:"
1280 PRINT Twopower
1290 STOP
1300 END IF
1310 NEXT Value
1320 DISP "HP-IB VERIFICATION TEST 3.2"
1330 OUTPUT Analyzer;"DSP,""HP-IB VERIFICATION TEST 3.2""
1340 FOR Value=0 TO 9
1350 Twopower=2^Value
1360 Send$="*HSE,"&VAL$(Twopower)&";*HSE?"
1370 OUTPUT Analyzer;Send$
1380 WAIT .2
1390 ENTER Analyzer;Result
1400 IF Result<>Twopower THEN
1410 PRINT "TEST 3.2 FAILED, TEST ABORTED"
1420 OUTPUT Analyzer;"DSP,""TEST 3.2 FAILED, TEST ABORTED"
1430 PRINT "RETURNED VALUE OF H.W. STATUS IS:"
1440 PRINT Result
1450 PRINT "IT SHOULD BE:"
1460 PRINT Twopower
1470 STOP
1480 END IF
1490 NEXT Value
1500 DISP "HP-IB VERIFICATION TEST 3.3"
1510 OUTPUT Analyzer;"DSP,""HP-IB VERIFICATION TEST 3.3""
1520 OUTPUT Analyzer;"*HSR?"
1530 WAIT .2
1540 ENTER Analyzer;Result
1550 IF Result<>0 AND Result<>32 AND Result<>1024 AND Result<>1056 THEN
1560 PRINT "TEST 3.3 FAILED, TEST ABORTED"
1570 OUTPUT Analyzer;"DSP,""TEST 3.3 FAILED, TEST ABORTED""

```

Table 17-3. HP-IB Operation Verification Program (Continued)

```

1580 PRINT "H.W. STATUS REG SHOULD RETURN 0,32,1024, OR 1056. IT IS: ";Result
1590 STOP
1600 END IF
1610 DISP "HP-IB VERIFICATION TEST 3.4"
1620 OUTPUT Analyzer;"DSP, ""HP-IB VERIFICATION TEST 3.4""
1630 OUTPUT Analyzer;"*ESR?"
1640 WAIT .2
1650 ENTER Analyzer;Result
1660 IF Result<>128 AND Result<>64 AND Result<>0 THEN
1670 PRINT "TEST 3.4 FAILED, TEST ABORTED"
1680 OUTPUT Analyzer;"DSP, ""TEST 3.4 FAILED, TEST ABORTED""
1690 PRINT "EVENT STATUS REG. SHOULD RETURN 128, 64, OR 0; IT IS: ";Result
1700 STOP
1710 END IF
1720 DISP "HP-IB VERIFICATION TEST 3.5"
1730 OUTPUT Analyzer;"DSP, ""HP-IB VERIFICATION TEST 3.5""
1740 OUTPUT Analyzer;"INT;MTV,1;INP;SOUR,A;TRIG,MAN;LEV,2"
1750 WAIT 3
1760 OUTPUT Analyzer;"*HSR?"
1770 WAIT .2
1780 ENTER Analyzer;Result
1790 IF Result<>256 AND Result<>1056 THEN
1800 PRINT "TEST 3.5 FAILED, TEST ABORTED"
1810 OUTPUT Analyzer;"DSP, ""TEST 3.5 FAILED, TEST ABORTED""
1820 PRINT "H.W. STATUS REG SHOULD RETURN 256 OR 1056, IT IS: ";Result
1830 STOP
1840 END IF
1850 DISP "HP-IB VERIFICATION TEST 3.6"
1860 OUTPUT Analyzer;"DSP, ""HP-IB VERIFICATION TEST 3.6""
1870 OUTPUT Analyzer;"LOC"
1880 OUTPUT Analyzer;"*ESR?"
1890 WAIT .2
1900 ENTER Analyzer;Result
1910 OUTPUT Analyzer;"CLE;PRES"
1920 IF Result<>64 THEN
1930 PRINT "TEST 3.6 FAILED, TEST ABORTED"
1940 OUTPUT Analyzer;"DSP, ""TEST 3.6 FAILED, TEST ABORTED""
1950 PRINT "EVENT STATUS REGISTER SHOULD RETURN 64, IT IS: ";Result
1960 STOP
1970 END IF
1980 PRINT "TEST 3 Status Registers : PASSED"
1990 OUTPUT Analyzer;"DSP, ""TEST 3 PASSED""
2000 BEEP
2010 WAIT .2
2020 BEEP
2030 WAIT .2
2040 BEEP
2050 RETURN
2060 Test4: !!!!!!!!!!!!!!!!!!!!!!!!!!!!!!!!!!!!!!!!!!!!!!!!!!!!!!!!!!!!!!!!!!!!!!!
2070 ! TEST 4 !
2080 ! data transfer !
2090 !Tests the ability of the 5372A to transmit and receive data. !

```



Table 17-3. HP-IB Operation Verification Program (Continued)

```
2100 !!!!!!!!!!!!!!!!!!!!!!!!!!!!!!!!!!!!!!!!!!!!!!!!!!!!!!!!!!!!!!!!!!!!!
2110 Analyzer=703
2120 OUTPUT Analyzer;"CLE;PRES"
2130 OUTPUT Analyzer;"MEAS;FUNC FREQ"
2140 DISP "HP-IB VERIFICATION      TEST 4"
2150 OUTPUT Analyzer;"DSP,""HP-IB VERIFICATION      TEST 4""
2160 OUTPUT Analyzer;"NUM;DISP,BOLD;MENU,NUM"
2170 OUTPUT Analyzer;"DSP,""HP-IB VERIFICATION      TEST 4""
2180 OUTPUT Analyzer;"*TRG"
2190 ENTER Analyzer USING "#,K";Read_it
2200 IF Read_it<9.9E+6 OR Read_it>1.1E+7 THEN
2210     PRINT "TEST 5 FAILED, TEST ABORTED"
2220     OUTPUT Analyzer;"DSP,""TEST 4 FAILED, TEST ABORTED""
2230     PRINT "VALUE RETURNED IS ";Read_it
2240     STOP
2250 END IF
2260 PRINT "TEST 4 Data Transfer      : PASSED"
2270 WAIT 3
2280 OUTPUT Analyzer;"DSP,""TEST 4 PASSED"";LOC"
2290 FOR J=1 TO 4
2300     BEEP
2310     WAIT .1
2320 NEXT J
2330 RETURN
2340 END
```



## HP 5372A PERFORMANCE TEST RECORD (Page 1 of 6)

HEWLETT-PACKARD MODEL 5372A  
 FREQUENCY AND TIME INTERVAL ANALYZER

Repair/Work Order No. \_\_\_\_\_

Serial Number: \_\_\_\_\_

Temperature: \_\_\_\_\_

Test Performed By: \_\_\_\_\_

Relative Humidity: \_\_\_\_\_

Date: \_\_\_\_\_

Post-Calibration Test:

Notes: \_\_\_\_\_

Pre-Calibration Test:

Recommended Instrument	Test	Results		
		Minimum	Actual	Maximum
	Operation Verification	Pass _____ Fail _____		
	HP-IB Verification	Pass _____ Fail _____		
	<b>CHANNEL A AND B TESTS</b>			
	<b>Frequency Range/ Dynamic Range</b>			
3325A	.125 Hz 45 mVp-p 0 V Offset  Freq: Chan A Chan B	121.000 000 000 mHz 121.000 000 000 mHz	_____	129.000 000 000 mHz 129.000 000 000 mHz
3325A	.125 Hz 2 Vp-p 0 V Offset (Square Wave)  Freq: Chan A Chan B	124.930 000 000 mHz 124.930 000 000 mHz	_____	125.070 000 000 mHz 125.070 000 000 mHz
8663A	500 MHz 15 mVrms (45 mVp-p) 0 V Offset  Freq: Chan A Chan B	499.999 999 90 MHz 499.999 999 90 MHz	_____	500.000 000 10 MHz 500.000 000 10 MHz
8663A	500 MHz 10 dBm (2 Vp-p) 0 V Offset  Freq: Chan A Chan B	499.999 999 90 MHz 499.999 999 90 MHz	_____	500.000 000 10 MHz 500.000 000 10 MHz
	<b>Signal Operating Range</b>			
3325A	10 MHz 2 Vp-p 1 V Offset  Freq: Chan A Chan B	9.999 999 800 MHz 9.999 999 800 MHz	_____	10.000 000 200 MHz 10.000 000 200 MHz
3325A	10 MHz 2 Vp-p 1 V Offset  Freq: Chan A Chan B	9.999 999 800 MHz 9.999 999 800 MHz	_____	10.000 000 200 MHz 10.000 000 200 MHz



## HP 5372A PERFORMANCE TEST RECORD (Page 3 of 6)

HEWLETT-PACKARD MODEL 5372A FREQUENCY AND TIME INTERVAL ANALYZER				
Recommended Instrument	Test	Results		
		Minimum	Actual	Maximum
<b>CHANNEL A AND B TESTS (Continued)</b>				
3325A	1 KHz 2 Vp-p -1 V Offset	PkAmp Chan A		
		Max. -400 mV		+400 mV
	Min. -2.4 V		-1.6 V	
	PkAmp Chan B			
		Max. -400 mV		+400 mV
		Min. -2.4 mV		-1.6 mV
8663A	200 MHz 71 mVrms (200 mVp-p) 0 V Offset	PkAmp Chan A		
		Max. +60 mV		+140 mV
	Min. -140 mV		-60 mV	
	PkAmp Chan B			
		Max. +60 mV		+140 mV
		Min. -140 mV		-60 mV
8663A	200 MHz 10 dBm (2 Vp-p) 0 V Offset	PkAmp Chan A		
		Max. +600 mV		+1.4 V
	Min. -1.4 V		-600 mV	
	PkAmp Chan B			
		Max. +600 mV		+1.4 V
		Min. -1.4 V		-600 mV
<b>Sensitivity/ Minimum Pulse Width (optional)</b>				
8131A	1.0 ns Pulse 100.0 ns Period 45 mVp-p 0 V Offset	± TI Chan A	700 ps	
				1.3 ns
8131A	1.5 ns Pulse 100.0 ns Period 45 mVp-p 0 V Offset	± TI Chan A	1.2 ns	
				1.8 ns

## HP 5372A PERFORMANCE TEST RECORD (Page 4 of 6)

HEWLETT-PACKARD MODEL 5372A FREQUENCY AND TIME INTERVAL ANALYZER				
Recommended Instrument	Test	Results		
		Minimum	Actual	Maximum
	<b>EXTERNAL ARM TESTS*</b>			
	<b>Frequency Range/ Dynamic Range</b>			
3325A	1 Hz 140 mVp-p 0 V Offset	Gate Time	993.000 000 0 ms	1.007 000 000 0 s
3325A	1 Hz 5 Vp-p 0 V Offset (Square Wave)	Gate Time	993.000 000 0 ms	1.007 000 000 0 s
8663A	100 MHz 50 mVrms (140 mVp-p) 0 V Offset	Gate Time	99.8 ns	100.2 ns
	<b>Signal Operating Range</b>			
3325A	10 MHz 5 Vp-p 2.5 V Offset	Gate Time	199.8 ns	200.2 ns
3325A	10 MHz 5 Vp-p -2.5 V Offset	Gate Time	199.8 ns	200.2 ns
	<b>Trigger Accuracy</b>			
3325A	Variable Offset	Ext Arm	Max. Trigger Level _____ Min. Trigger Level _____	
		Ext Arm Trigger Level Accuracy†	-20 mV	+20 mV
	<b>Sensitivity/Minimum Pulse Width</b>			
8161A	5.0 ns Pulse 200.0 ns Period 140 mVp-p 0 V Offset (Square Wave)	Gate Time	199.8 ns	200.2 ns

\* A 50Ω feedthrough termination must be connected to the External Arm input.

† TRIGGER LEVEL ACCURACY =  $\left[ \frac{\text{MAX. TRIGGER LEVEL} - \text{MIN. TRIGGER LEVEL}}{2} \right] \times 100\text{mV}$

## HP 5372A PERFORMANCE TEST RECORD (Page 5 of 6)

HEWLETT-PACKARD MODEL 5372A FREQUENCY AND TIME INTERVAL ANALYZER				
Recommended Instrument	Test	Results		
		Minimum	Actual	Maximum
	<b>OPTION 060/090 REAR PANEL EXTERNAL ARM TESTS*</b>			
	<b>Frequency Range/Dynamic Range</b>			
3325A	1 Hz 280 mVp-p 0 V Offset	Gate Time	993.000 000 0 ms	1.007 000 000 0 s
3325A	1 Hz 5 Vp-p 0 V Offset (Square Wave)	Gate Time	993.000 000 0 ms	1.007 000 000 0 s
8663A	100 MHz 100 mVrms (280 mVp-p) 0 V Offset	Gate Time	99.8 ns	100.2 ns
	<b>Signal Operating Range</b>			
3325A	10 MHz 5 Vp-p 2.5 V Offset	Gate Time	199.8 ns	200.2 ns
3325A	10 MHz 5 Vp-p -2.5 V Offset	Gate Time	199.8 ns	200.2 ns
	<b>Trigger Accuracy</b>			
3325A	Variable Offset	Ext Arm	Max. Trigger Level _____ Min. Trigger Level _____	
		Ext Arm Trigger Level Accuracy†	-20 mV	+20 mV
	<b>Sensitivity/ Minimum Pulse Width</b>			
8161A	5.0 ns Pulse 200.0 ns Period 280 mVp-p 0 V Offset (Square Wave)	Gate Time	199.8 ns	200.2 ns

\* A 50Ω feedthrough termination must be connected to the External Arm input.

$$† \text{ TRIGGER LEVEL ACCURACY} = \frac{\text{MAX TRIGGER LEVEL} + \text{MIN TRIGGER LEVEL}}{2} - 100\text{mV}$$

HP 5372A PERFORMANCE TEST RECORD (Page 6 of 6)

HEWLETT-PACKARD MODEL 5372A FREQUENCY AND TIME INTERVAL ANALYZER				
Recommended Instrument	Test	Results		
		Minimum	Actual	Maximum
8663A	OPTION 030/090 CHANNEL C TESTS			
	Frequency Range/ Dynamic Range/ Sensitivity			
	100 MHz -25 dBm	Freq: Chan C	99.999 999 96 MHz	100.000 000 04 MHz
	100 MHz +7 dBm	Freq: Chan C	99.999 999 98 MHz	100.000 000 02 MHz
	1.5 GHz -25 dBm	Freq: Chan C	1.499 999 999 7 GHz	1.500 000 000 3 GHz
	1.5 GHz +7 dBm	Freq: Chan C	1.499 999 999 7 GHz	1.500 000 000 3 GHz
	1.55 GHz -20 dBm	Freq: Chan C	1.549 999 999 7 GHz	1.550 000 000 3 GHz
	1.55 GHz +7 dBm	Freq: Chan C	1.549 999 999 7 GHz	1.550 000 000 3 GHz
2.0 GHz -20 dBm	Freq: Chan C	1.999 999 999 6 GHz	2.000 000 000 4 GHz	
2.0 GHz +7 dBm	Freq: Chan C	1.999 999 999 6 GHz	2.000 000 000 4 GHz	

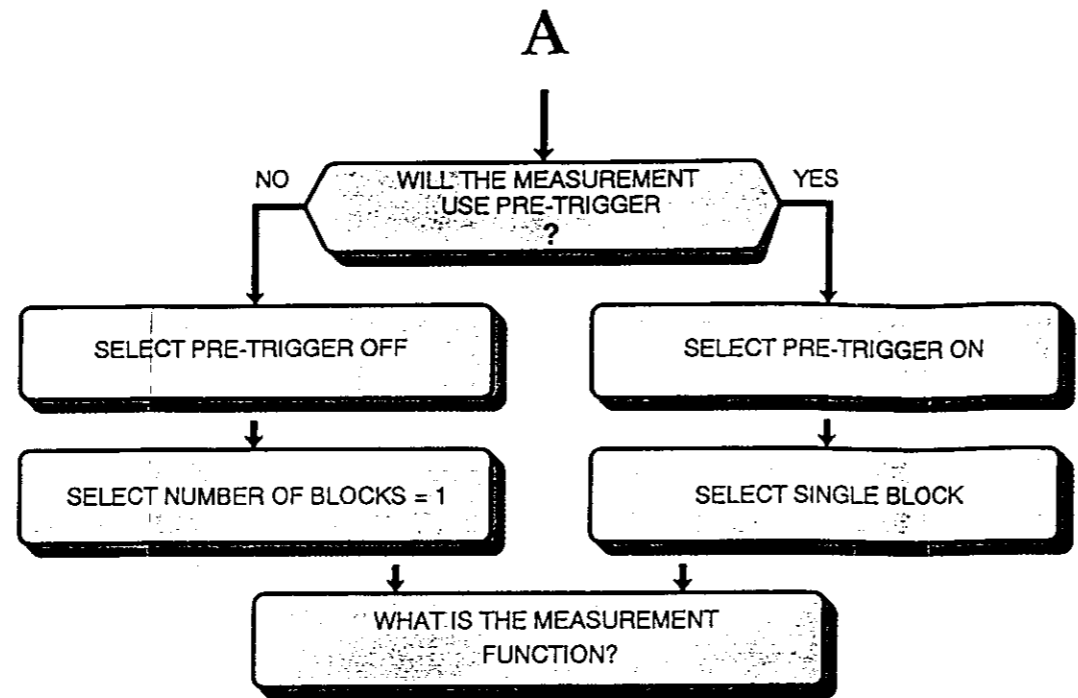

NOTE

PRE-TRIGGER IS NOT AVAILABLE FOR THE FOLLOWING ARMING MODES: TIME SAMPLING, EDGE / TIME, EDGE / EVENT, TIME / TIME, AND EVENT / EVENT.

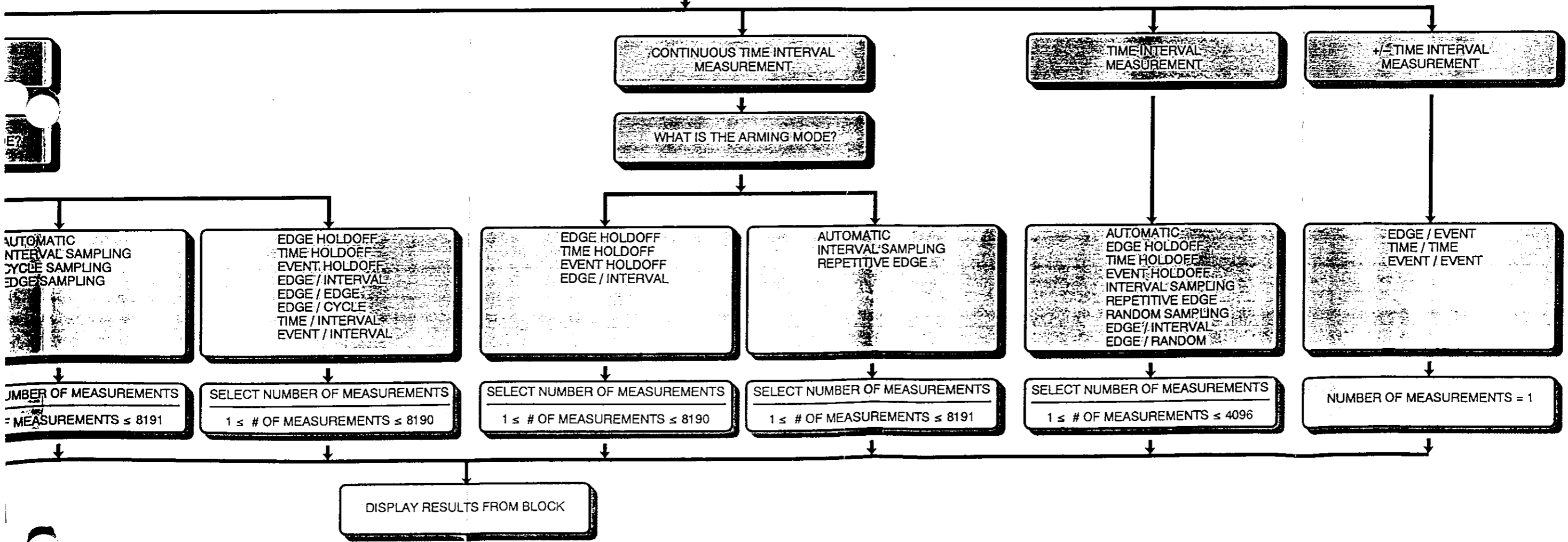



## FUNCTION MENU GUIDE

To Select a Menu Map:

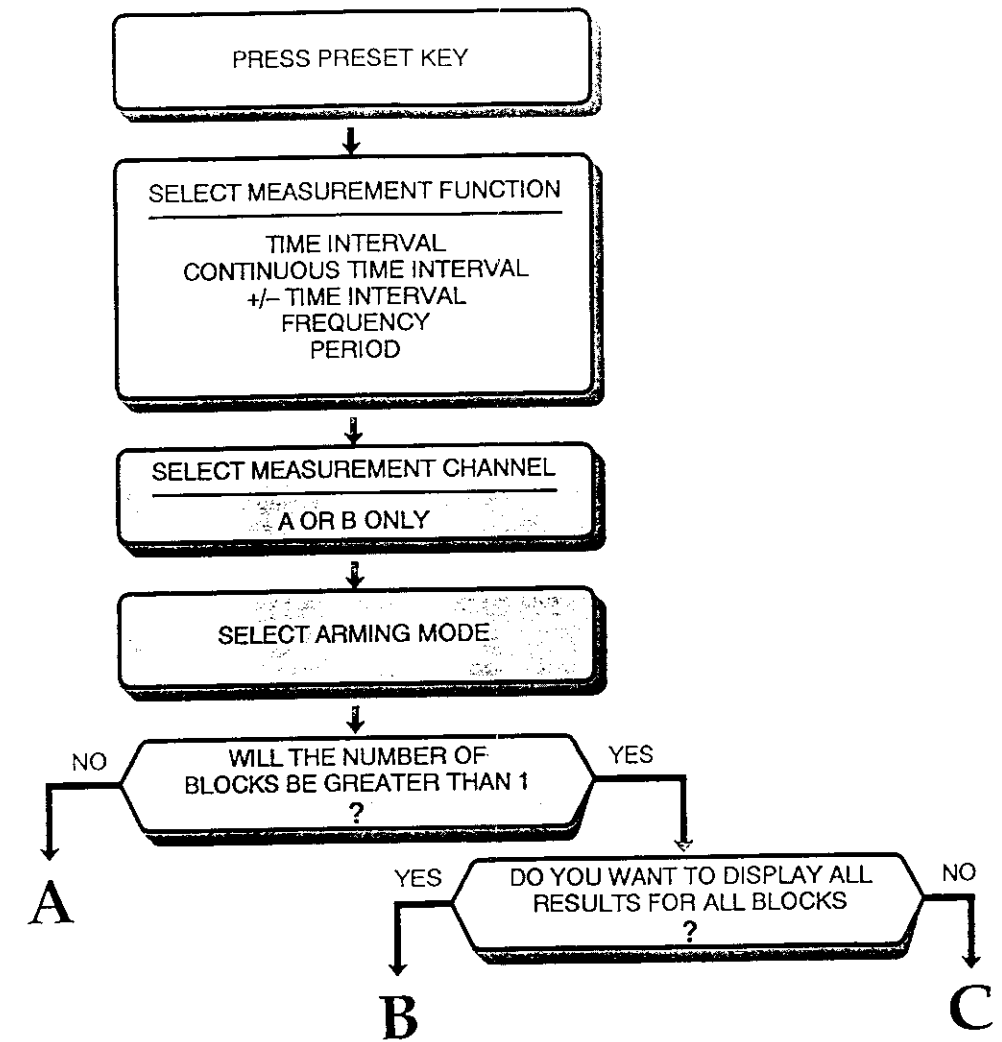

BD\_TOPN3M





# FUNCTION MENU MAP A

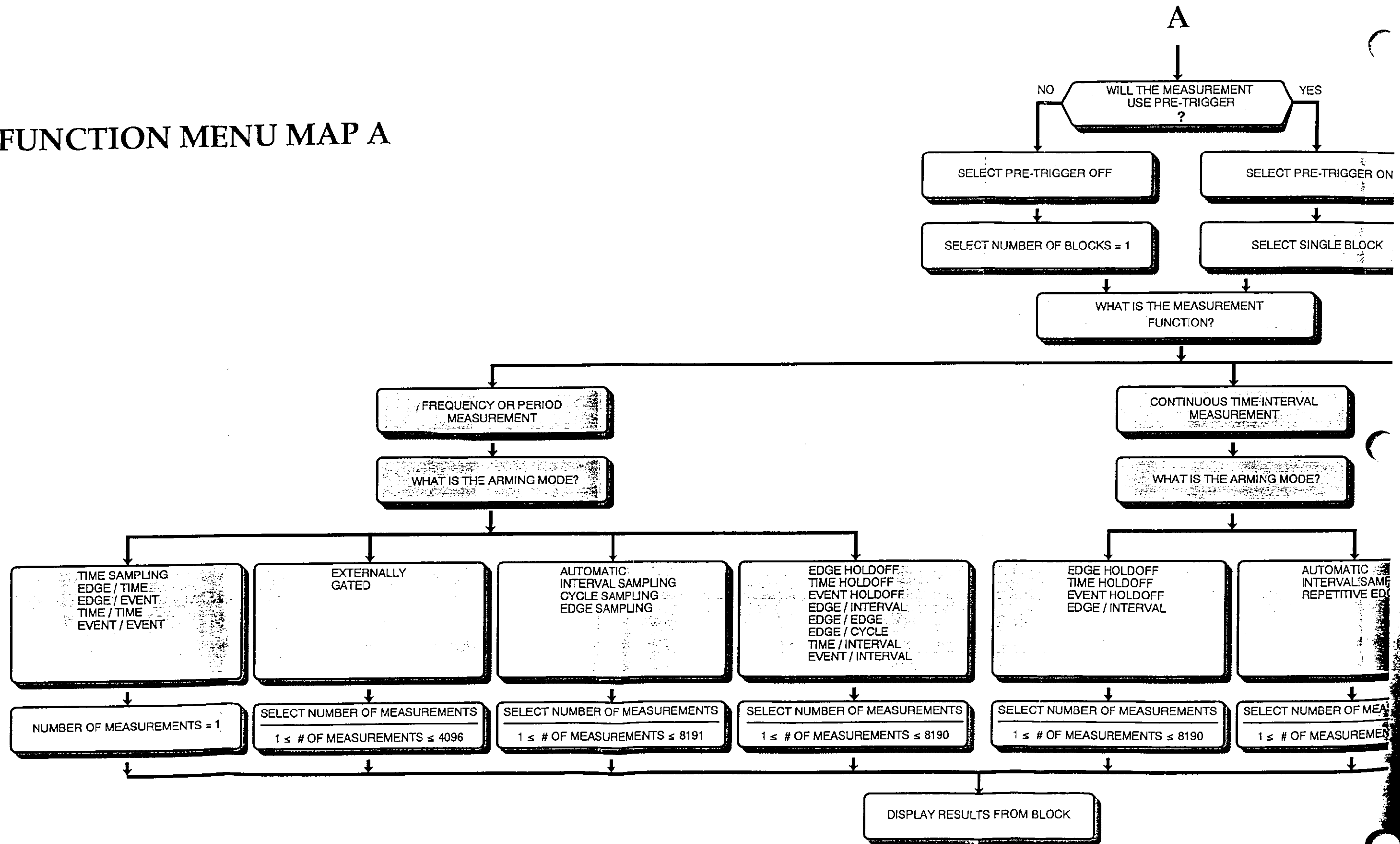



## FUNCTION MENU GUIDE

To Select a Menu Map:

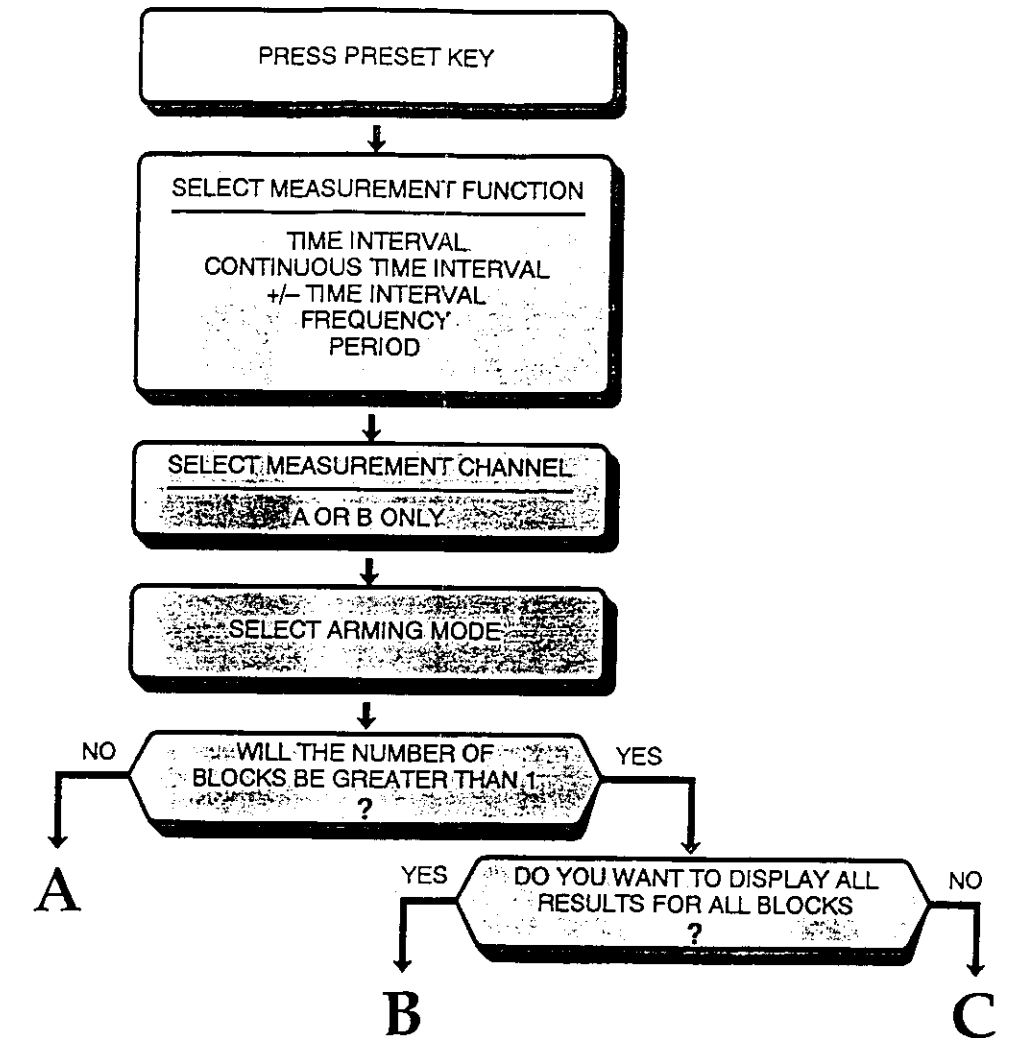

BD\_TOPN3M



**B**

SELECT PRE-TRIGGER OFF

WHAT IS THE MEASUREMENT FUNCTION?

CONTINUOUS TIME INTERVAL MEASUREMENT

WHAT IS THE ARMING MODE?

TIME INTERVAL MEASUREMENT

+/-TIME INTERVAL MEASUREMENT

EDGE HOLDOFF  
TIME HOLDOFF  
EVENT HOLDOFF  
EDGE / INTERVAL  
EDGE / EDGE  
EDGE / CYCLE  
TIME / INTERVAL  
EVENT / INTERVAL

AUTOMATIC  
INTERVAL SAMPLING  
REPETITIVE EDGE

EDGE HOLDOFF  
TIME HOLDOFF  
EVENT HOLDOFF  
EDGE / INTERVAL

AUTOMATIC  
EDGE HOLDOFF  
TIME HOLDOFF  
EVENT HOLDOFF  
INTERVAL SAMPLING  
REPETITIVE EDGE  
RANDOM SAMPLING  
EDGE / INTERVAL  
EDGE / RANDOM

EDGE / EVENT  
TIME / TIME  
EVENT / EVENT

SELECT NUMBER OF BLOCKS  
 $1 < \# \text{ OF BLOCKS} \leq 2730$

SELECT NUMBER OF BLOCKS  
 $1 < \# \text{ OF BLOCKS} \leq 4096$

SELECT NUMBER OF BLOCKS  
 $1 < \# \text{ OF BLOCKS} \leq 2730$

SELECT NUMBER OF BLOCKS  
 $1 < \# \text{ OF BLOCKS} \leq 4096$

SELECT NUMBER OF BLOCKS  
 $1 < \# \text{ OF BLOCKS} \leq 4096$

SELECT NUMBER OF MEASUREMENTS  
 $1 \leq \# \text{ OF MEAS} \leq \frac{8192 - [2 \times \# \text{ OF BLOCKS}]}{\# \text{ OF BLOCKS}}$

SELECT NUMBER OF MEASUREMENTS  
 $1 \leq \# \text{ OF MEAS} \leq \frac{8192 - \# \text{ OF BLOCKS}}{\# \text{ OF BLOCKS}}$

SELECT NUMBER OF MEASUREMENTS  
 $1 \leq \# \text{ OF MEAS} \leq \frac{8192 - [2 \times \# \text{ OF BLOCKS}]}{\# \text{ OF BLOCKS}}$

SELECT NUMBER OF MEASUREMENTS  
 $1 \leq \# \text{ OF MEAS} \leq \frac{8192 - [2 \times \# \text{ OF BLOCKS}]}{[2 \times \# \text{ OF BLOCKS}]}$

NUMBER OF MEASUREMENTS = 1

DISPLAY AVERAGED RESULTS FOR ALL BLOCKS

DISPLAY ALL RESULTS FOR ALL BLOCKS

DISPLAY AVERAGED RESULTS FOR ALL BLOCKS

DISPLAY ALL RESULTS FOR ALL BLOCKS



# FUNCTION MENU MAP B

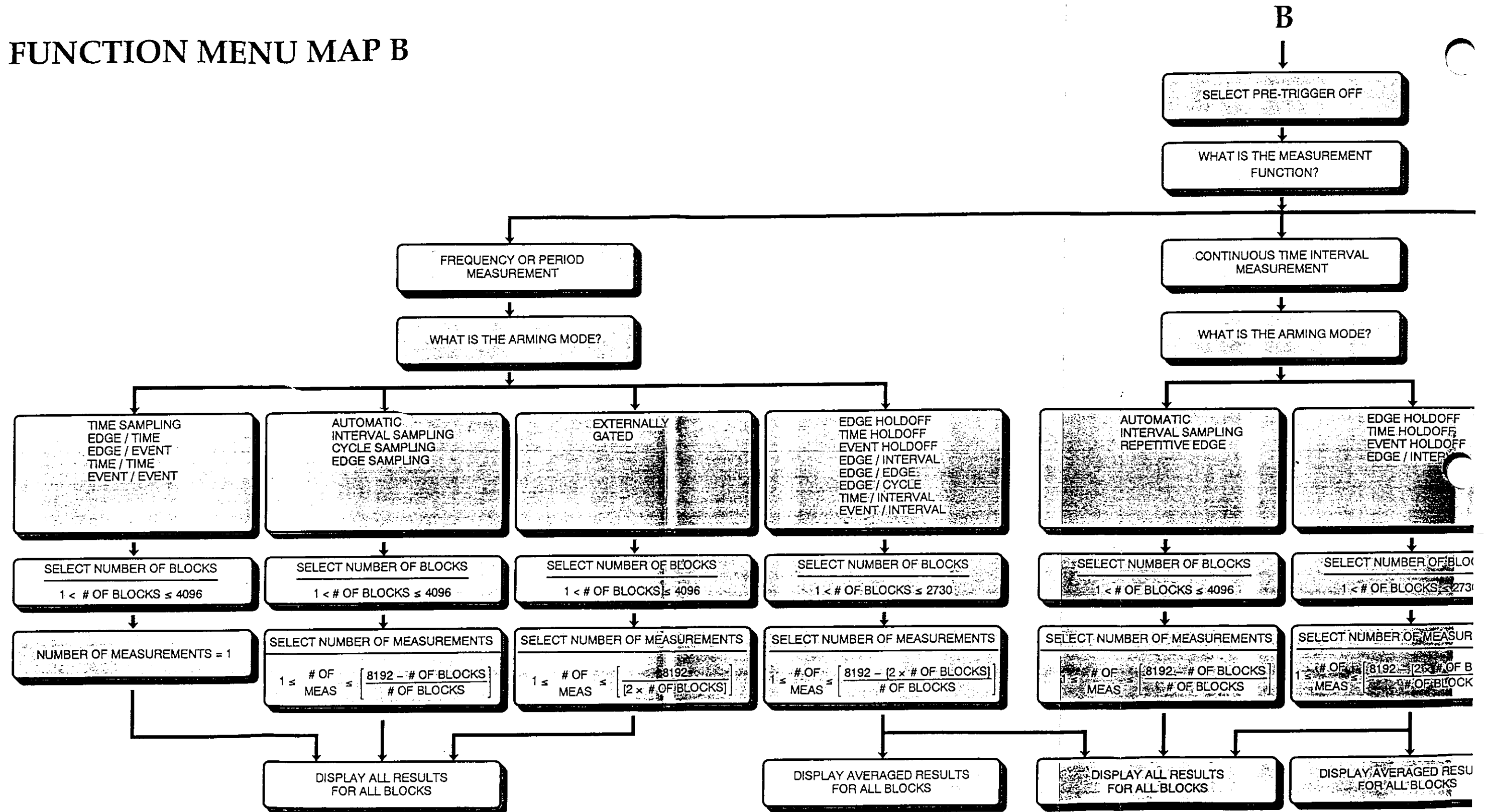





B

SELECT PRE-TRIGGER OFF

WHAT IS THE MEASUREMENT FUNCTION?

CONTINUOUS TIME INTERVAL MEASUREMENT

WHAT IS THE ARMING MODE?

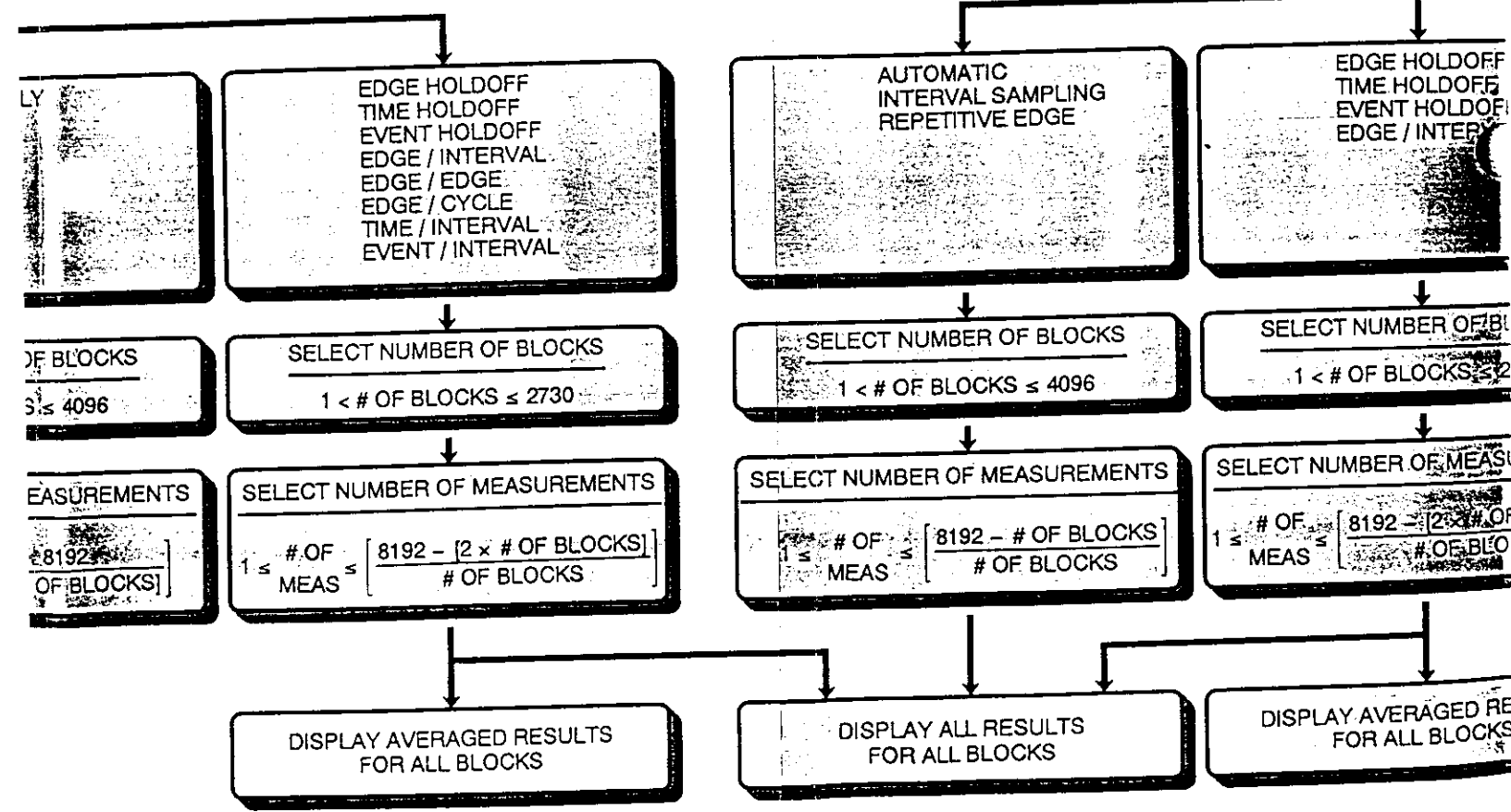



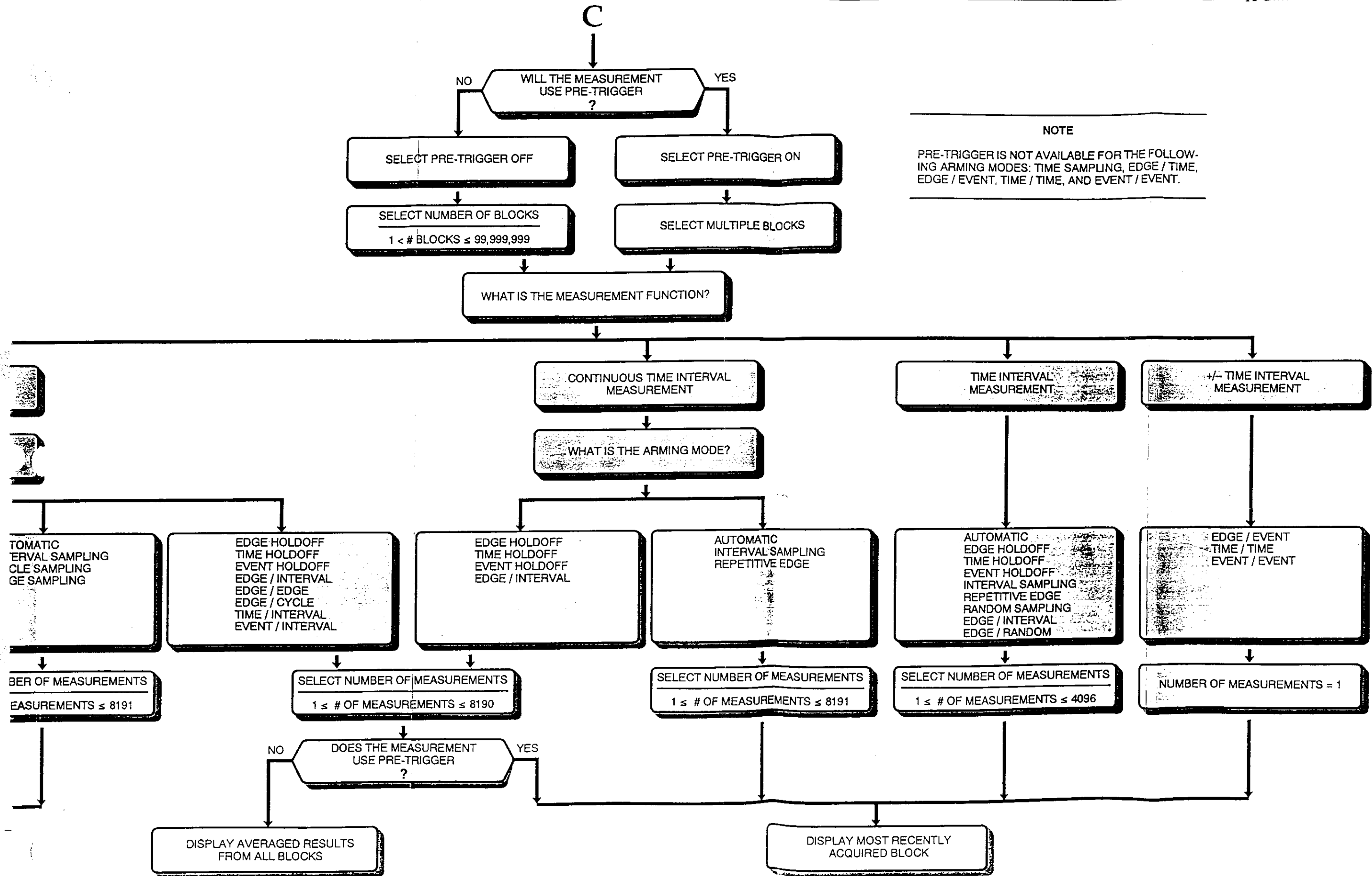

**NOTE**  
PRE-TRIGGER IS NOT AVAILABLE FOR THE FOLLOWING ARMING MODES: TIME SAMPLING, EDGE / TIME, EDGE / EVENT, TIME / TIME, AND EVENT / EVENT.



# FUNCTION MENU MAP C

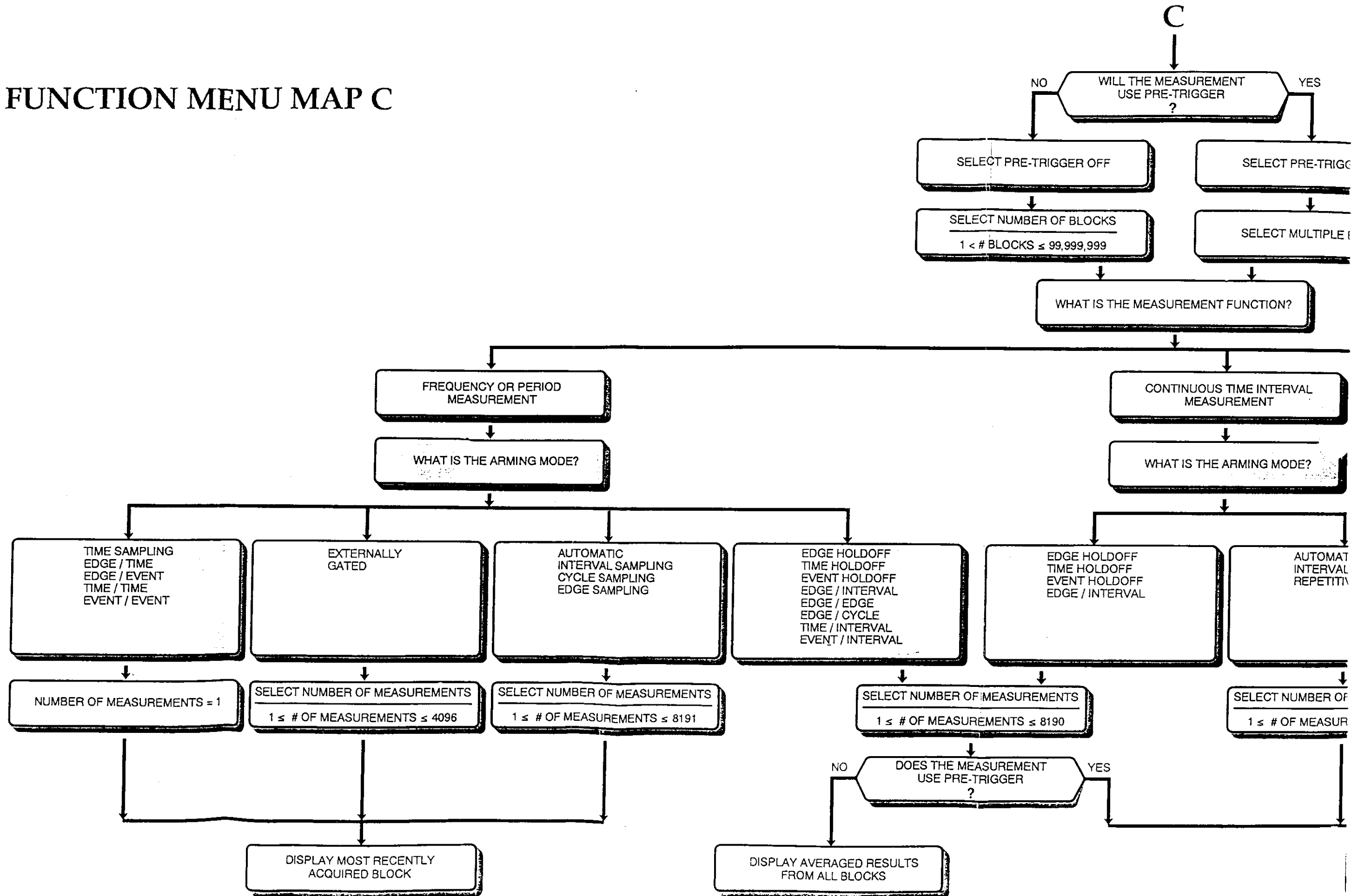



## UNPACKING AND INSTALLING

---

### INTRODUCTION

This section provides installation instructions including unpacking, initial inspection, storage, and shipment information for the HP 5372A Frequency and Time Interval Analyzer.

### UNPACKING AND INSPECTION

#### **WARNING**

---

**TO AVOID HAZARDOUS ELECTRIC SHOCK, DO NOT PERFORM ELECTRICAL TESTS WHEN THERE ARE SIGNS OF SHIPPING DAMAGE TO ANY PORTION OF THE OUTER ENCLOSURE (COVERS, PANELS, CONNECTORS, LEADS, ETC.).**

---

Inspect the shipping container and cushioning material for damage. If damage is evident, keep the packing materials until the contents of the shipment have been checked for completeness and the instrument has been checked mechanically and electrically. If the contents are incomplete, if there is mechanical damage or defect, or if the instrument or some component fails the performance tests, notify the nearest Hewlett-Packard office. If the shipping container is damaged, or the cushioning material shows signs of stress, notify the carrier as well as the Hewlett-Packard office. Keep the shipping materials for the carrier's inspection. The HP office will arrange for repair or replacement at HP's option without waiting for a claim settlement.

### PREPARATION FOR USE

#### **Operating Environment**

**TEMPERATURE.** The instrument may be operated in temperatures from 0° C to 40° C.





## Contents of Appendix

---











Introduction .....	B-1
Unpacking and Inspection .....	B-1
Preparation For Use .....	B-1
Operating Environment .....	B-1
Bench Operation .....	B-2
 Power Requirements .....	B-2
 Line Voltage and Fuse Selection .....	B-3
Power Cable .....	B-4
Hewlett-Packard Interface Bus (HP-IB) .....	B-6
HP-IB Interconnections .....	B-6
HP-IB Address Selection .....	B-8
HP-IB Descriptions .....	B-8
Rack Mounting Kits .....	B-8
Storage and Shipment .....	B-9
Environment .....	B-9
Packaging .....	B-9
Original Packaging .....	B-9
Other Packaging .....	B-9

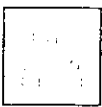

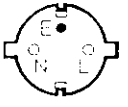
Table B-1. AC Power Cables Available

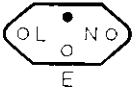
Plug Type	Cable HP Part No.	*C D	Plug Description	Cable Length (Inches)	Cable Color	For Use In Country
250V 	8120-1351 8120-1703	0 6	Straight **BS1363A 90°	90 90	Mint Gray Mint Gray	United Kingdom, Cyprus, Nigeria, Rhodesia, Singapore
250V 	8120-1369 8120-0696	0 4	Straight **NZSS198/ASC112 90°	79 87	Gray Gray	Australia, New Zealand
250V 	8120-1689 8120-1692	7 2	Straight **CEE7-Y11 90°	79 79	Mint Gray Mint Gray	East and West Europe, Egypt, (Unpolarized in many nations)
125V 	8120-1348 8120-1398 8120-1754 8120-1378 8120-1521 8120-1676 8120-4753	5 5 7 1 6 2	Straight **NEMA5-15P 90° Straight **NEMA5-15P Straight **NEMA5-15P 90° Straight **NEMA5-15P Straight **NEMA5-15P	80 80 36 80 80 30 90	Black Black Black Jade Gray Jade Gray Jade Gray Dark Gray	United States, Canada, 100V or 200V, Mexico, Philippines, Taiwan, Saudi Arabia, Japan
250V 	8120-2104	3	Straight **SEV1011 1959-24507 Type 12	79	Gray	Switzerland
250V 	8120-0698	6	Straight **NEMA6-15P			United States, Canada
220V 	8120-2956 8120-2957	2 3	Straight **DHCK 107 90°	79 79	Gray Gray	Denmark
220V 	8120-4211 8120-4600		Straight 90°		Gray Gray	South Africa, India
<p>*CD - Check Digit (refer to Replaceable Parts in Service Manual).</p> <p>**Part number shown for plug is industry identifier for plug only. Number shown for cable is HP Part Number for complete cable including plug.</p> <p>E - Earth Ground    L - Line    N - Neutral</p>						

## HEWLETT-PACKARD INTERFACE BUS (HP-IB)

### HP-IB Interconnections

HEWLETT-PACKARD INTERFACE BUS. Interconnection data concerning the rear panel HP-IB connector is provided in *Figure B-2*. This connector is compatible with the HP10833A/B/C/D HP-IB cables. The HP-IB system allows interconnection of up to 15 (including the controller) HP-IB compatible instruments. The HP-IB cables have identical "piggy-back" connectors on both ends so that several cables can be connected to a single source without special adapters or switch boxes. System components and devices may be connected in virtually any configuration desired. There must, of course, be a path from the controller to every device operating on the bus. As a practical matter, avoid stacking more than three or four cables on any one connector. If the stack gets too large, the force on the stack produces great leverage which can damage the connector mounting. Be sure each connector is firmly (finger tight) screwed in place to keep it from working loose during use.

**CABLE LENGTH RESTRICTIONS.** To achieve design performance with the HP-IB, proper voltage levels and timing relationship must be maintained. If the system cable is too long, the lines cannot be driven properly. Therefore, when interconnecting an HP-IB system, it is important to observe the following rules:

- a. The total cable length for the system must be equal to or less than 2 meters (6.6 feet) times the total number of devices connected to the bus.
- b. The total cable length for the system must be less than or equal to 20 meters (65.6 feet).
- c. The total number of instruments connected to the bus must not exceed 15.

PIN	LINE
1	DIO1
2	DIO2
3	DIO3
4	DIO4
13	DIO5
14	DIO6
15	DIO7
16	DIO8
5	EOI
17	REN
6	DAV
7	NRFD
8	NDAC
9	IFC
10	SRQ
11	ATN
12	SHIELD-CHASSIS GROUND
18	P/O TWISTED PAIR WITH PIN 6
19	P/O TWISTED PAIR WITH PIN 7
20	P/O TWISTED PAIR WITH PIN 8
21	P/O TWISTED PAIR WITH PIN 9
22	P/O TWISTED PAIR WITH PIN 10
23	P/O TWISTED PAIR WITH PIN 11
24	ISOLATED DIGITAL GROUND

THESE PINS  
ARE  
INTERNALLY  
GROUNDED

**CAUTION**

The 5372A contains metric threaded HP-IB cable mounting studs as opposed to English threads. Metric threaded HP 10833A, B, C, or D HP-IB cable lock screws must be used to secure the cable to the instrument. Identification of the two types of mounting studs and lock screws is made by their color. English threaded fasteners are colored silver and metric threaded fasteners are colored black. DO NOT mate silver and black fasteners to each other or the threads of either or both will be destroyed. Metric threaded HP-IB cable lock screw illustration and part number follow.

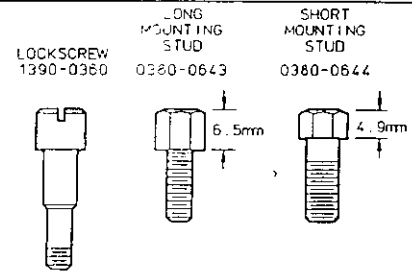

**Logic Levels**

The Hewlett-Packard Interface Bus logic levels are TTL compatible, i.e., the true (1) state is 0.0V dc to 0.4V dc and the false (0) state is +2.5V dc to +5.0V dc.

**Mating Connector**

HP 1251-0293; Amphenol 57-30240.

**Mating Cables Available**

HP 10631A, 1 metre (3.3 ft.), HP 10631B, 2 metres (6.6 ft.),  
HP 10631C, 4 metres (13.2 ft.), HP 10631D, 1/2 metre (1.5 ft.).

**Cabling Restrictions**

1. A Hewlett-Packard Interface Bus System may contain no more than 2 metres (6.6 ft.) of connecting cable per instrument.
2. The maximum accumulative length of connecting cable for any Hewlett-Packard Interface Bus System is 20.0 metres (65.6 ft.)
3. The maximum number of instruments in one system is fifteen.

Figure B-2. Hewlett-Packard Interface Bus Connection.

### **HP-IB Address Selection**

The HP-IB device address of the HP 5372A is selected from the front panel through the System menu. The address applies to both the talk and listen functions. The selectable addresses are from 0 to 30. Instructions for selecting the address are provided in chapter 12, "System Menu," of the *Operating Manual*.

The device address is retained in non-volatile memory. If the battery or memory fails, the address defaults to "3".

### **HP-IB Descriptions**

A description of the Hewlett-Packard Interface Bus (HP-IB) is provided in the *HP5372A Programming Manual*. Study of the information in the Programming Manual is necessary if you are not familiar with HP-IB concepts. Additional information concerning the design criteria and operation of the bus is available in IEEE Standard 488-1987, titled *Standard Digital Interface for Programming Instrumentation*.

### **RACK MOUNTING KITS**

The available rack mount kits are:

- Option 908 Rack Mount Flange Kit — without front carrying handles
- Option 913 Rack Mount Flange Kit — with front carrying handles

In the Option 908 rack mount kit, handles are not supplied; thus, this rack mount kit supplies the hardware required to mount the HP 5372A in a standard rack with the flanges only. In the Option 913 rack mount kit, handles are supplied; thus, this rack mount kit supplies the hardware required to mount the HP 5372A in a standard rack with flanges and handles.

The rack mounting contents and detailed installation instructions are provided with each rack mount kit. If a kit was not ordered with the instrument, it can be ordered through your nearest HP Sales and Support Office by using the following part numbers: HP Part Number 5061-9678 for Option 908 or HP Part Number 5061-9772 for Option 913.

A Rack Slide-Mount Kit (HP Part Number 1494-0059) is also available. The rack slide lessens the need to lift the HP 5372A, which weighs 25.5 kg (56 lbs).

## STATUS AND ERROR MESSAGES

---

### INTRODUCTION

Five types of messages appear on the CRT Status Line of the HP 5372A to indicate errors, failures, and general information. This appendix contains a complete list of all messages in alphabetical order. The messages have a priority order; from the lowest to the highest priority, they are:

- Static Status Messages
- Momentary Status Messages
- Momentary Warning Messages
- Static Error Messages
- Static Failure Messages

These messages are acknowledged in different ways, depending on whether the instrument can continue operating and making measurements. Some messages are only warnings, and normal operation can continue without user response. Others are intended to notify the user that operation has been suspended until the error condition is acknowledged and/or corrected.

Displayed messages are replaced with ones of higher priority. For example, a Static Error Message will overwrite a Momentary Warning Message. If another message occurs with the same priority as the current message, overwriting occurs only if both are Status or if both are Momentary messages. Otherwise, the second message will be ignored.

### STATIC STATUS MESSAGES

These are information messages to inform you of the condition of the instrument. Static Status Messages are cleared when the condition in the instrument changes, or when the RESTART key is pressed.

**MOMENTARY  
STATUS MESSAGES**

These are information messages to alert you to a particular condition in the instrument. They will clear automatically after three seconds.

**MOMENTARY  
WARNING  
MESSAGES**

These are warning messages to alert you to an illegal operation that was attempted. They will clear automatically after three seconds. Examples of actions that generate a Momentary Warning Message are: pressing an undefined softkey, or pressing a non-numeric key while entering a numeric value. An error number will be placed in the Error Queue for each Momentary Warning Message.

**STATIC ERROR  
MESSAGES**

Static errors convey improper operating states or errors generated by HP-IB. Pressing a valid key clears these errors. HP-IB errors are cleared on the transition from REMOTE to LOCAL. Examples of Static Errors are: sending an invalid HP-IB command, or attempting to query the instrument while it is in Binary output mode. An error number will be placed in the Error Queue for each Static Error Message.

**STATIC FAILURE  
MESSAGES**

These are failures which prevent the instrument from operating properly. They convey "catastrophic" hardware-related failure conditions. Static failures must be acknowledged by pressing the RESTART key or by correcting the failure condition. Examples of Static Failures are: applying too much voltage to the Channel A or B input pods, or neglecting to power-down the instrument before removing one of the input pods. An error number will be placed in the Error Queue for each Static Failure Message.

**ERROR QUEUE  
QUERY COMMAND**

The Error Queue query command ("ERR?") allows an HP-IB system controller to request the contents of the HP 5372A's Error Queue. The Error Queue contains a maximum of 16 error numbers, represented by integer values, which identify operator or hardware errors. If more than 16 errors have been queued but not queried, then the 16th one is replaced with Error -350 (which is the HP standard error number indicating that "too many errors have occurred"). Successively sending the query "ERR?" returns error numbers in the order that they occurred, until the queue is empty. Additional queries return an error of "0" until another error condition is generated. Only messages of the type Momentary Warning, Static Error and Static Failure have error numbers that are entered into the Error Queue.



**STATUS AND  
ERROR MESSAGE  
DESCRIPTIONS**

The following list describes the HP 5372A system-wide status and error messages in alphabetical order. HP standard numbers, which are consistently defined for all HP instruments, are listed under "Error", and are preceded with a minus sign (for example, "Error -120: Numeric argument error"). All of the other error messages with positive numbers are unique to the HP 5372A. Messages with numbers are used to indicate actual events which have occurred which should be logged in the Error Queue. Messages without error numbers are intended for status information only.

Note that there are also some localized messages in the Graphics screens which are not covered here in detail. Those messages are intended to give the user feedback on the current Graph status, but are not generally considered errors of global concern, and do not generate error number entries in the Error Queue. Examples are: the number of measurements between the markers, the status indication while the graph display is being recalculated (due to a GRAPHic command), or an indication that some action has completed (such as a Graph copy to memory). These messages are considered to be self-explanatory and therefore are not listed here.

**Abort only  
allowed in Single**

*Type:* Momentary  
Status

*Associated With:* Measurement

This message occurs when the "ABORT" HP-IB command is received or the Abort (MANUAL ARM) key is pressed while the HP 5372A is in the Repetitive Sample mode. The Abort command is valid only when the HP 5372A is in Single Sample mode, so no action takes place.

**Acquiring  
measurement data**

*Type:* Static Status

*Associated With:* System Operation

This message occurs while the HP 5372A is acquiring measurement data. It is erased when the acquisition process is complete.

**Alternate Timebase  
selected. Press  
RESTART.**

*Type:* Static Failure

*Associated With:* Rear Panel External  
Reference Input

*Error Number:* 105

The HP 5372A will display this message and stop the measurement process when an external timebase reference is connected to, or disconnected from, the rear panel EXTERNAL

INPUT connector. Press the front panel RESTART key or send the HP-IB "RESTART" command to restart measurements. If the message was caused by connecting the external reference, the restarted measurements will be based on that external reference, otherwise, they will be based on the Internal Timebase.

**Arming has changed.**

*Type:* Momentary Status      *Associated With:* Parameter Coupling

This message occurs when the Arming selection has been changed to resolve conflict with another parameter that has been entered (such as changing Measurement Function).

**Arming parameter changed.**

*Type:* Momentary Status      *Associated With:* Parameter Coupling

This message occurs when an Arming parameter has been changed to resolve conflict with another parameter that has been entered. Examples of Arming parameters that might be changed are: Arming channel or delay value.

**Arming value changed by Fast Meas mode.**

*Type:* Momentary Status      *Associated With:* Parameter Coupling

This message occurs when an Arming value has been changed to accomodate the Fast Measurement mode. This mode restricts arming to occur within 131  $\mu$ sec.

**Arming, input parameters changed.**

*Type:* Momentary Status      *Associated With:* Parameter Coupling

This message occurs when both the Arming selection and one or more Input menu parameters have been changed to resolve conflict with another parameter that has been entered. Examples of Input menu parameters that might change are: Trigger Mode, Trigger Slope or Trigger Level.

**Arming, measurement source have changed.**

*Type:* Momentary Status      *Associated With:* Parameter Coupling

This message occurs when both the Arming selection and Measurement Source channel have been changed to resolve conflict with the Measurement Function that has been entered.

**Binary output  
turned off.**

*Type:* Momentary  
Status

*Associated With:* Parameter  
Coupling

This message occurs when the instrument is in the Binary output mode, and the Peak Amplitude function has been selected. Binary output mode is not supported for Peak Amplitude measurements. The instrument defaults to ASCII output mode.

**Block or Measurement  
size changed.**

*Type:* Momentary  
Status

*Associated With:* Parameter  
Coupling

This message occurs if a Block Size or Measurement Size is entered which causes the total number of measurements to exceed  $2E+15$ . This is applicable to Histogram TI modes in particular. When this happens, the entered parameter is allowed, but the other is defaulted to keep the total acquisition size less than  $2E+15$  measurements. For example, if the Measurement Size is 20,000,000 measurements, the maximum Block Size enterable is 99,999,999 (to insure that the total is less than  $2E+15$ ). If the Measurement Size is increased (so that it is greater than 20,000,000), the corresponding Block Size is decreased to keep the total less than  $2E+15$  measurements.

**Calculating  
measurements.**

*Type:* Static Status

*Associated With:* System Operation

This message is displayed while the HP 5372A is calculating the measurement results. It is erased when the calculation process is complete.

**Decimal point entry  
disallowed.**

*Type:* Momentary  
Status

*Associated With:* Numeric Entry

This message occurs when a decimal point is not allowed at this point in the current numeric entry sequence, because the exponent value has already been specified (e.g. the value currently being entered is "1.2E+01").

**Decimal point  
previously entered.**

*Type:* Momentary  
Status

*Associated With:* Numeric Entry

This message occurs when a decimal point is not allowed at this point in the current numeric entry sequence, because a decimal point has already been entered (e.g. the value currently being entered is "1.2").

Enter register number.

Type: Static Status

This message appears when you press the function keys, prompting configuration.

Binary output  
turner

**Error -100:  
Unrecognized  
command.**

Type: Static Error

This message occurs when you enter a command via HP-IB. Examples are: command not currently specified subsystem, command not currently measurement setup, or command not supported errors.

Block or

**Error -120:  
Numeric Argument  
error.**

Type: Static Error

Associated With: Standard HP Error

This message occurs when an attempt has been made to enter a Stop arming value less than the corresponding Start arming value in TIME/TIME or EVENT/EVENT Arming modes. Examples are: entering a Start time greater than a Stop time, or entering a Start event count greater than a Stop event count.

**Error -151:  
Query not allowed.  
Binary format.**

Type: Static Error

Associated With: Standard HP Error

This message occurs when output data is requested from the HP 5372A while it is in the Binary output mode. The HP 5372A cannot be queried or send formatted numeric data via HP-IB while in Binary output mode. To process queries, switch to ASCII or Floating Point output modes.

**Error 100:  
No Listeners on bus.**

Type: Momentary  
Warning

Associated With: HP-IB

This message occurs when there are no listeners present on the bus, and an attempt has been made to have the HP 5372A send output. This is specific to the Talk/Listen mode of operation.

**Error 101:  
Talker, no listeners.**

Type: Momentary  
Warning

Associated With: HP-IB

This message occurs when the HP 5372A is addressed to talk,

but there are no listeners present on the bus. This is specific to the Talk-only mode of operation.

**Error 102:  
Bus conflict:  
Talk-only.**

*Type:* Static Error      *Associated With:* HP-IB

This message occurs when an attempt is made to send HP-IB commands to the HP 5372A while it is in Talk-Only mode. The instrument cannot accept commands via HP-IB while in this mode. To allow the HP 5372A to accept commands, return to Talk/Listen mode.

**Error 103:  
Key ignored in  
Remote.**

*Type:* Momentary      *Associated With:* HP-IB  
Warning

This message occurs when a front panel key is pressed while the HP 5372A is in Remote mode. While in Remote, all front panel keys except LOCAL are disabled.

**Error 104:  
Key ignored in LLO.**

*Type:* Momentary      *Associated With:* HP-IB  
Warning

This message occurs when the LOCAL key is pressed while the HP 5372A is in Remote, and in Local Lockout mode. In Local Lockout mode, the LOCAL key is disabled.

**Error 107:  
Timebase unlocked.  
Press RESTART.**

*Type:* Static Failure      *Associated With:* Hardware Error

This message occurs when the oscillator is out of lock. Any measurements made while this message is on the screen may not be accurate.

**Error 108:  
Ch A and B  
Overvoltage.**

*Type:* Static Failure      *Associated With:* Hardware Error

This message occurs when an overvoltage condition is present on both Input Channels A and B. To correct this error, change the signal Trigger Level, Bias or Attenuation on the Input menu.

**Error 109:  
Ch A Overvoltage.**

*Type:* Static Failure      *Associated With:* Hardware Error

This message occurs when an overvoltage condition is present on Input Channel A. To correct this error, change the signal Bias or Attenuation on the Input menu.

**Error 110:**      *Type:* Static Failure      *Associated With:* Hardware Error  
**Ch B Overvoltage.**

This message occurs when an overvoltage condition is present on Input Channel B. To correct this error, change the signal Bias or Attenuation on the Input menu.

**Error 111:**      *Type:* Static Failure      *Associated With:* Hardware Error  
**Power-down before  
removing pods.**

This message occurs when an input pod is removed while the HP 5372A is powered on. The instrument should be powered down before input pods are removed.

**Error 130:**      *Type:* Momentary      *Associated With:* Plot  
**Only graphs can be**  
**Warning**  
**plotted.**

This message occurs when an attempt is made to plot a display other than Graphics. Plots are only allowed of Graphic displays. To get a hardcopy of any other menu, use the PRINT function, which outputs the current display to an attached printer.

**Error 131:**      *Type:* Momentary      *Associated With:* Plot  
**Plot/meas data**  
**Warning**  
**conflict.**

This message occurs when the PLOT key is pressed while Graphics are available, but the output source chosen on the System menu is Measurement instead of Display. In this case, the HP 5372A has been configured to output measurement results instead of display data. Set the output source to Display before plotting.

**Error 140:**      *Type:* Momentary      *Associated With:* Save/Recall  
**Register protected.**  
**Warning**

This message occurs when an attempt was made to save the current instrument configuration to a register that is protected. Save to another register, or unprotect the desired register on the Instrument State Menu.

**Error 141:**      *Type:* Momentary      *Associated With:* Save/Recall  
**Register not saved yet.**  
**Warning**

This message occurs when an attempt has been made to recall a saved instrument configuration from a register that has not yet been saved.

**Error 142: Register  
out of range.**

*Type:* Momentary  
Warning

*Associated With:* Save/Recall

This message occurs when a register number outside the valid range has been entered. Valid register numbers are 0-9 for RECALL, and 1-9 for SAVE or ERASE.

**Error 150:  
Parameter conflict.**

*Type:* Static Error

*Associated With:* HP-IB

This message occurs when an HP-IB command was sent which conflicts with the current instrument configuration.

**Error 160:  
Out of sensitivity cal.**

*Type:* Static Failure

*Associated With:* Hardware Error

This message occurs when the HP 5372A has lost its battery-stored memory and the sensitivity calibration factors have been lost. When this occurs, the factors are set to defaults, and the HP 5372A needs calibration.

**Events occurred  
which were not timed.**

*Type:* Momentary  
Status

*Associated With:* Measurement

This message occurs when the measurement acquisition process is not able to timestamp every event sample individually. All measurement results displayed are still valid in this case; no user-intervention is required.

**Exponent entry  
disallowed.**

*Type:* Momentary  
Status

*Associated With:* Numeric Entry

This message occurs for one of two reasons: an attempt was made to enter an integer parameter using exponent format, but the menu field is too small to adequately handle that format (not enough space to specify digits plus the "E+00" notation), or the EXP key was pressed without having entered any digits in the current numeric entry sequence.

**Exponent disallowed  
due to mantissa.**

*Type:* Momentary  
Status

*Associated With:* Numeric Entry

This message occurs if there is not enough space left in the numeric entry field to show "E+00" when the EXP key is pressed. In this case, the exponent entry mode is valid for the parameter in question, but there is not enough space left in the field because too many digits have already been entered.

There must be at least four character spaces available to show "E+xx" in the field. The BACKSPACE key may be used to clear enough character spaces to allow exponent entry.

**Gate open.**            *Type:* Static Status            *Associated With:* Manual Totalize Measurement

This message appears while the manually controlled gate is open during a Manually armed Totalize measurement. When the gate is closed to complete the measurement, the message is erased and the measurement result is displayed.

**Graphics not allowed for this meas.**            *Type:* Momentary Status            *Associated With:* Manual Totalize and Peak Amplitude Measurements

Graphics displays are not allowed when the HP 5372A is making Manually armed Totalize or Peak Amplitude measurements.

**HP 5372A Graphics command no longer used.**            *Type:* Momentary Warning            *Associated With:* HP-IB            *Error Number:* 120

This message occurs if an unsupported HP 5371A Graphics command is sent via HP-IB. See Appendix F for details on how HP 5371A commands may be translated into equivalent HP 5372A commands.

**Inhibit usage may distort results.**            *Type:* Momentary Status            *Associated With:* Inhibit function

When the Inhibit function is activated, the requested number of measurements will be made, but not all results may be valid. The Numeric screen and Graphics displays indicate which measurements have been inhibited during the measurement sequence.

**Input line truncated to first 80 chars.**            *Type:* Momentary Status            *Associated With:* HP-IB

This message occurs when an HP-IB string of more than 80 characters is entered from the controller. The parser truncates the string to the first 80 characters, and continues processing.



**Input parameters may have changed.**

*Type:* Momentary Status

*Associated With:* Parameter Coupling

This message occurs when parameters on the Input menu have been changed to resolve conflict with another parameter that has been entered. In this case, no Arming mode or Arming parameter changes have occurred.

**Interval sample value changed to 131  $\mu$ s.**

*Type:* Momentary Status

*Associated With:* Parameter Coupling

This message occurs when Fast Measurement mode is selected, causing an out-of-limits condition for the interval sample value. 131  $\mu$ sec is the maximum interval sample value allowed in Fast Measurement mode.

**Measurement Aborted.**

*Type:* Momentary Status

*Associated With:* Measurement

This message occurs when the "ABORT" HP-IB command is received or the Abort (MANUAL ARM) key is pressed while a measurement is in progress, and enough samples have been taken to give at least one valid measurement result. The Abort command is valid only when the HP 5372A is in Single Sample mode.

**Measurement Inhibited.**

*Type:* Static Status

*Associated With:* Measurement

This message occurs when Inhibit mode is activated, and at least one measurement in the last acquisition sequence was inhibited.

**Measurement terminated, no data.**

*Type:* Momentary Status

*Associated With:* Measurement

This message occurs when the "ABORT" HP-IB command is received or the Abort (MANUAL ARM) key is pressed while a measurement is in progress, and not enough samples have been taken to give at least one valid measurement result. The Abort command is valid only when the HP 5372A is in Single mode.

**No digits specified,  
entry aborted.**

*Type:* Momentary  
Status

*Associated With:* Numeric Entry

This message occurs when the ENTER key is pressed, without having specified a numeric value containing any digits.

**Non-numeric key  
ignored.**

*Type:* Momentary  
Status

*Associated With:* Numeric Entry

This message occurs in numeric entry when pressing any non-numeric key before pressing ENTER or LAST VALUE. Non-numeric keys are keys other than 0 to 9, . (decimal point), EXP, +/-, or BACKSPACE.

**Not in Talk-only.**

*Type:* Momentary  
Status

*Associated With:* Print/Plot  
Graph keys

This message occurs when an attempt is made to print a screen or plot a graph without first setting the HP 5372A to Talk-Only mode on the System menu screen.

**Number must be  
positive.**

*Type:* Momentary  
Status

*Associated With:* Numeric Entry

This message occurs when an attempt is made to change an enterable parameter to a negative value, and that parameter is only allowed to be positive. Examples are: Measurement Size, or Arming on event or time values.

**Numeric entry  
aborted.**

*Type:* Momentary  
Status

*Associated With:* Numeric Entry

This message occurs when the LAST VALUE key is pressed. The parameter that was being entered is restored to its previous value.

**Out of Range: see  
Meas mode on  
System menu.**

*Type:* Momentary  
Status

*Associated With:* Parameter Conflict

This message occurs when a parameter value is entered which conflicts with the limitations of Fast Measurement mode. However, the parameter value may be within the valid range for Normal Measurement mode (Measurement mode is selectable on the System menu).



**Source channel has changed.**

*Type:* Momentary Status

*Associated With:* Parameter Coupling

This message occurs when the Measurement Source channel has been changed to resolve conflict with another parameter that has been entered (such as changing the Measurement Function).

**Source, input parameters changed.**

*Type:* Momentary Status

*Associated With:* Parameter Coupling

This message occurs when the Measurement Source channel and one or more Input menu parameters have been changed to resolve conflict with another parameter that has been entered (such as changing the Measurement Function).

**Stop Arming precedes Start Arming.**

*Type:* Momentary Status

*Associated With:* Parameter Validation

This message appears when the Stop Arming value is less than the Start Arming value. The stop arm will thus occur before the start arm. If you are making  $\pm$  Time Interval measurements, expect negative results.

**Undefined key.**

*Type:* Momentary Status

*Associated With:* Key entries

This message occurs when an invalid or undefined key is pressed. An example is an undefined softkey.

**Value out of range: set to limit.**

*Type:* Momentary Status

*Associated With:* Numeric Entry

This message occurs when parameter values have been altered to resolve conflict with the selection of Fast Measurement mode.

**Value out of range: set to maximum.**

*Type:* Momentary Status

*Associated With:* Numeric Entry

This message occurs when the entered parameter value is above the maximum allowable value. The parameter is defaulted to that maximum value.

**Value out of range:  
set to minimum.**

*Type:* Momentary  
Status

*Associated With:* Numeric Entry

This message occurs when the entered parameter value is below the minimum allowable value. The parameter is defaulted to that minimum value.

**Waiting for arming...**

*Type:* Static Status

*Associated With:* Measurement  
Status

This message occurs when the HP 5372A is waiting for the specified arming event to occur, before making the first measurement.

**Waiting for  
input signal...**

*Type:* Static Status

*Associated With:* Measurement  
Status

This message occurs when the HP 5372A has met the specified arming condition, and is waiting for measurements to begin (no input signal has been detected).

**Waiting for  
Manual Arm...**

*Type:* Static Status

*Associated With:* Measurement  
Status

This message appears when a Totalize measurement with Manual arming is started. The HP 5372A is waiting for the MANUAL ARM key to be pressed which will open the gate.

**Waiting for  
Pre-trigger...**

*Type:* Static Status

*Associated With:* Measurement  
Status

This message occurs when the HP 5372A is waiting for the specified Pre-trigger condition to occur, before making a block of measurements.

**Waiting for  
Start Arming...**

*Type:* Static Status

*Associated With:* Measurement  
Status

This message appears when the measurement in progress is waiting for the start arm to occur.

**Waiting for  
Stop Arming...**

*Type:* Static Status      *Associated With:* Measurement Status

This message appears when the measurement in progress is waiting for the stop arm to occur.

**WARNING:  
Both frequencies out  
of auto-trigger range.**

*Type:* Momentary Warning      *Associated With:* System Operation  
*Error Number:* 182

This message occurs when the instrument is in Auto-trigger mode, and the input signals on both Channel A and B are outside the Auto-trigger frequency range. One input signal is below 1 kHz and one signal is above 200 MHz.

**WARNING:  
Frequency too high  
for auto-trigger.**

*Type:* Momentary Warning      *Associated With:* System Operation  
*Error Number:* 180

This message occurs when the instrument is in Auto-trigger mode, and the input signal is above 200 MHz. The Auto-trigger frequency range is 1 kHz to 200 MHz.

**WARNING:  
Frequency too low for  
auto-trigger.**

*Type:* Momentary Warning      *Associated With:* System Operation  
*Error Number:* 181

This message occurs when the instrument is in Auto-trigger mode, and the input signal is below 1 kHz. The Auto-trigger frequency range is 1 kHz to 200 MHz.

27 CAMBRIDGE







## Contents of Appendix

---

Introduction .....	D-1
Equipment Required .....	D-1
Procedure .....	D-2



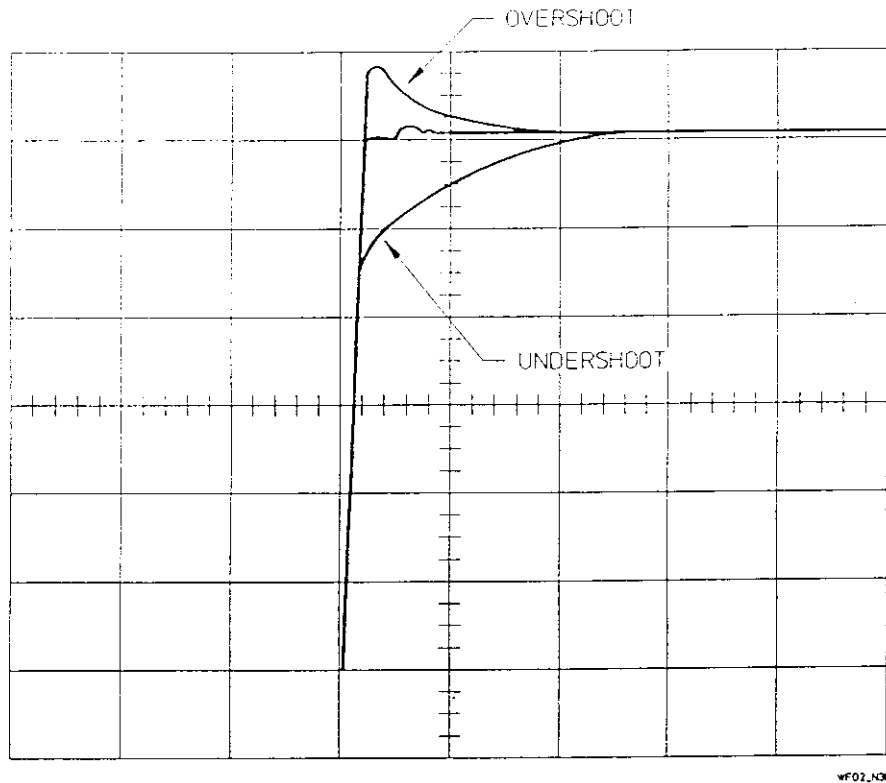

Figure D-2. Example of Overshoot and Undershoot

The calibration procedure helps eliminate overshoot and undershoot resulting from the use of an uncalibrated probe with the HP 54003A pod. An uncalibrated probe can produce triggering errors causing the HP 5372A to make erroneous measurements.

During the calibration procedure, the shape of the waveform being measured by the HP 5372A is changing. As the probe capacitor is adjusted, the waveform, if viewed on an oscilloscope, would be similar to the waveforms shown in Figure D-2.

The signal from the probe being calibrated:

- approaches overshoot in step 4;
- approaches undershoot in step 5;
- approaches a flat response in step 6.



1. SPECIFICATIONS



## Contents of Appendix

---

Warranted Specifications .....	E-1
Measurement Functions .....	E-1
Frequency .....	E-1
Period .....	E-2
Frequency or Period Ratio .....	E-3
Totalize .....	E-3
Time Interval .....	E-4
Time Deviation .....	E-4
Rise Time A and Fall Time A .....	E-5
Positive and Negative Pulse Width A .....	E-6
Duty Cycle A .....	E-6
Phase .....	E-7
Phase Deviation .....	E-8
Peak Amplitudes A, B .....	E-8
Input .....	E-9
Channel A and B .....	E-9
External Arm .....	E-10
Channel C (Option 030 or Option 090) .....	E-11
Rear Panel Connectors .....	E-11
Frequency Standard External Input .....	E-11
Inhibit .....	E-11
Option 060 Rear Panel Inputs .....	E-12
Time Base .....	E-12
Frequency .....	E-12
Stability .....	E-12
General .....	E-13
Operating Characteristics .....	E-14
Arming Modes .....	E-14
Holdoff Arming .....	E-14
Sample Arming .....	E-14
Holdoff/Sample Arming .....	E-15
Pre-trigger .....	E-15
Rear Panel Connectors .....	E-15
Gate Outputs 1 and 2 .....	E-15
Arm Delay Outputs 1 and 2 .....	E-16
Inhibit Input .....	E-16

TI Detect Output .....	E-16
Measurement Uncertainty Definitions .....	E-17
Least Significant Digit, Resolution, and Accuracy .....	E-17
Trigger Error and Trigger Level Timing Error .....	E-18
Example Measurements and Uncertainty Calculations .....	E-20
TTL Pulse Width Measurement .....	E-20
ECL Edge-to-Edge, or Single-Period Measurement .....	E-21
ECL Frequency Measurement .....	E-22



**WARRANTED  
SPECIFICATIONS  
(Continued)**

**Frequency or  
Period Ratio**

Range:

Channel A and B: 250 mHz [16 kHz] to 500 MHz (2 ns to 4.0 s [65 μs]).

Channel C: 100 MHz to 2 GHz (0.5 ns to 10 ns).

Least Significant Digit Displayed:

$$\pm \frac{200\text{ps}}{\text{Sample Interval}} \times \text{Ratio}$$

Resolution:

$$\pm \frac{150\text{ps rms} + (1.4 \times \text{Trigger Error})}{\text{Sample Interval}} \times \text{Ratio}$$

Accuracy (for Frequency A/B):

$$\pm \text{Resolution} \pm \frac{\text{Time Base Aging} \times \text{Frequency A}}{\text{Time Base Aging} \times \text{Frequency B}}$$

**Totalize**

Resolution:

**± 1 count of input per measurement sample, for each channel.**

For A/B:

$$\pm \frac{\text{Totalize Result A} \pm 1}{\text{Totalize Result B} \mp 1}$$

For B/A:

$$\pm \frac{\text{Totalize Result B} \pm 1}{\text{Totalize Result A} \mp 1}$$

Accuracy:

**± Resolution**

**WARRANTED  
SPECIFICATIONS  
(Continued)**

**Time Interval**

Range:

Time Interval: **10 ns to 8.0 s [131 μs].**

Continuous Time Interval: **100 ns [75 ns] to 8.0 s [131 μs].**

± Time Interval: **- 4.0 s [- 65 μs] to +4.0 [+ 65 μs], including 0 seconds.**

Least Significant Digit Displayed:

N = number of measurements averaged.

$$\pm \frac{200 \text{ ps}}{\sqrt{N}}$$

Resolution:

$$\pm \frac{150 \text{ ps rms} \pm \text{Start Trigger Error} \pm \text{Stop Trigger Error}}{\sqrt{N}}$$

Accuracy:

$$\pm \text{Resolution} \pm (\text{Time Base Aging} \times \text{Time Interval}) \pm \text{Trigger Level Timing Error} \pm 1 \text{ ns Systematic Error.}$$

**Time Deviation**

Signal Input Range:

**2 ns to 8.0 s [131 μs].**

Least Significant Digit Displayed:

± 200 ps.

Resolution:

±150 ps rms ± (1.4 x Trigger Error).

Accuracy:

$$\pm \text{Resolution} \pm (\text{Time Base Aging} \times \text{Time Interval}) \pm 1 \text{ ns Systematic Error.}$$

**Automatic Carrier Determination**

rms Resolution (for Number of Measurements per Block ≥ 3):

$$\frac{\sqrt{13.5 \times (150 \text{ ps rms} + 1.4 \times \text{Trigger Error})}}{(\text{Number of Blocks})^{1/2} \times (\text{Number of Measurements per Block})^{3/2} \times \text{Sample Interval}} \times \text{Frequency}$$

Accuracy:

$$\pm \text{Resolution} \pm (\text{Time Base Aging} \times \text{Frequency}).$$

**WARRANTED  
SPECIFICATIONS  
(Continued)**

**Frequency or  
Period Ratio**

Range:

Channel A and B: 250 MHz [16 kHz] to 500 MHz (2 ns to 4.0 s [65  $\mu$ s]).

Channel C: 100 MHz to 2 GHz (0.5 ns to 10 ns).

Least Significant Digit Displayed:

$$\pm \frac{200\text{ps}}{\text{Sample Interval}} \times \text{Ratio}$$

Resolution:

$$\pm \frac{150\text{ps rms} + (1.4 \times \text{Trigger Error})}{\text{Sample Interval}} \times \text{Ratio}$$

Accuracy (for Frequency A/B):

$$\pm \text{Resolution} \pm \frac{\text{Time Base Aging} \times \text{Frequency A}}{\text{Time Base Aging} \times \text{Frequency B}}$$

**Totalize**

Resolution:

$\pm 1$  count of input per measurement sample, for each channel.

For A/B:

$$\pm \frac{\text{Totalize Result A} \pm 1}{\text{Totalize Result B} \mp 1}$$

For B/A:

$$\pm \frac{\text{Totalize Result B} \pm 1}{\text{Totalize Result A} \mp 1}$$

Accuracy:

$\pm$  Resolution

**WARRANTED  
SPECIFICATIONS  
(Continued)**

**Time Interval**

Range:

Time Interval: **10 ns to 8.0 s [131 μs].**

Continuous Time Interval: **100 ns [75 ns] to 8.0 s [131 μs].**

**± Time Interval: - 4.0 s [- 65 μs] to +4.0 [+ 65 μs], including 0 seconds.**

Least Significant Digit Displayed:

N = number of measurements averaged.

$$\pm \frac{200 \text{ ps}}{\sqrt{N}}$$

Resolution:

$$\pm \frac{150 \text{ ps rms} \pm \text{Start Trigger Error} \pm \text{Stop Trigger Error}}{\sqrt{N}}$$

Accuracy:

$$\pm \text{Resolution} \pm (\text{Time Base Aging} \times \text{Time Interval}) \pm \text{Trigger Level Timing Error} \pm 1 \text{ ns Systematic Error.}$$

**Time Deviation**

Signal Input Range:

**2 ns to 8.0 s [131 μs].**

Least Significant Digit Displayed:

**± 200 ps .**

Resolution:

**±150 ps rms ± (1.4 x Trigger Error).**

Accuracy:

$$\pm \text{Resolution} \pm (\text{Time Base Aging} \times \text{Time Interval}) \pm 1 \text{ ns Systematic Error.}$$

**Automatic Carrier Determination**

rms Resolution (for Number of Measurements per Block ≥ 3):

$$\frac{\sqrt{13.5 \times (150 \text{ ps rms} + 1.4 \times \text{Trigger Error})}}{(\text{Number of Blocks})^{1/2} \times (\text{Number of Measurements per Block})^{3/2} \times \text{Sample Interval}} \times \text{Frequency}$$

Accuracy:

$$\pm \text{Resolution} \pm (\text{Time Base Aging} \times \text{Frequency}).$$

# SPECIFICATIONS

## WARRANTED SPECIFICATIONS

### Measurement Functions

#### Frequency

The HP 5372A has two measurement modes - Normal and Fast. If there are differences in the two modes, parameters pertaining to the Fast mode will be contained in brackets [ ].

#### RANGE

Single Channel Measurements:

Channels A and B: 125 mHz [8 kHz] to 500 MHz.

Channel C: 100 MHz to 2 GHz.

Dual Channel Measurements:

Channels A and B: 250 mHz [16 kHz] to 500 MHz.

Channel C: 100 MHz to 2 GHz.

#### FOR A SINGLE MEASUREMENT

Least Significant Digit Displayed:

$$\pm \frac{200\text{ps}}{\text{Sample Interval}} \times \text{Frequency}$$

Resolution:

$$\pm \frac{150\text{ps rms} + (1.4 \times \text{Trigger Error})}{\text{Sample Interval}} \times \text{Frequency}$$

Accuracy:

$$\pm \text{Resolution} \pm (\text{Time Base Aging} \times \text{Frequency}).$$

#### MEAN ESTIMATION FOR AVERAGE MEASUREMENTS

rms Resolution:

Continuous Measurements (Number of Measurements per Block  $\geq 3$ ):

$$\frac{\sqrt{13.5 \times (150\text{ps rms} + 1.4 \times \text{Trigger Error})}}{(\text{Number of Blocks})^{1/2} \times (\text{Number of Measurements per Block})^{3/2} \times \text{Sample Interval}} \times \text{Frequency}$$

**WARRANTED  
SPECIFICATIONS  
(Continued)**

All other Measurements:  
 N = number of measurements averaged.  

$$\pm \frac{150 \text{ ps rms} + (1.4 \times \text{Trigger Error})}{\text{Sample Interval} \times \sqrt{N}} \times \text{Frequency}$$

Accuracy:  

$$\pm \text{Resolution} \pm (\text{Time Base Aging} \times \text{Frequency}).$$

**Period**

**RANGE**

Single Channel Measurements:

Channels A and B: 2 ns to 8.0 s [131 μs].  
 Channel C: 0.5 ns to 10 ns.

Dual Channel Measurements:

Channels A and B: 2 ns to 4.0 s [65 μs].  
 Channel C: 0.5 ns to 10 ns.

**FOR A SINGLE MEASUREMENT**

Least Significant Digit Displayed:

$$\pm \frac{200\text{ps}}{\text{Sample Interval}} \times \text{Period}$$

Resolution:

$$\pm \frac{150 \text{ ns rms} + (1.4 \times \text{Trigger Error})}{\text{Sample Interval}} \times \text{Period}$$

Accuracy:

$$\pm \text{Resolution} \pm (\text{Time Base Aging} \times \text{Period}).$$

**MEAN ESTIMATION FOR AVERAGED MEASUREMENTS**

rms Resolution:

Continuous Measurements (Number of Measurements per Block ≥ 3):

$$\frac{\sqrt{13.5} \times (150\text{ps rms} + (1.4 \times \text{Trigger Error}))}{(\text{Number of Blocks})^{1/2} \times (\text{Number of Measurements per Block})^{3/2} \times \text{Sample Interval}} \times \text{Period}$$

All other Measurements:

N = number of measurements averaged.

$$\pm \frac{150\text{ps rms} + (1.4 \times \text{Trigger Error})}{\text{Sample Interval} \times \sqrt{N}} \times \text{Period}$$

Accuracy:

$$\pm \text{Resolution} \pm (\text{Time Base Aging} \times \text{Period}).$$

# SPECIFICATIONS

## WARRANTED SPECIFICATIONS

### Measurement Functions

#### Frequency

The HP 5372A has two measurement modes - Normal and Fast. If there are differences in the two modes, parameters pertaining to the Fast mode will be contained in brackets [ ].

#### RANGE

Single Channel Measurements:

Channels A and B: 125 mHz [8 kHz] to 500 MHz.

Channel C: 100 MHz to 2 GHz.

Dual Channel Measurements:

Channels A and B: 250 mHz [16 kHz] to 500 MHz.

Channel C: 100 MHz to 2 GHz.

#### FOR A SINGLE MEASUREMENT

Least Significant Digit Displayed:

$$\pm \frac{200\text{ps}}{\text{Sample Interval}} \times \text{Frequency}$$

Resolution:

$$\pm \frac{150\text{ps rms} + (1.4 \times \text{Trigger Error})}{\text{Sample Interval}} \times \text{Frequency}$$

Accuracy:

$$\pm \text{Resolution} \pm (\text{Time Base Aging} \times \text{Frequency}).$$

#### MEAN ESTIMATION FOR AVERAGE MEASUREMENTS

rms Resolution:

Continuous Measurements (Number of Measurements per Block  $\geq 3$ ):

$$\frac{\sqrt{13.5} \times (150\text{ps rms} + 1.4 \times \text{Trigger Error})}{(\text{Number of Blocks})^{1/2} \times (\text{Number of Measurements per Block})^{3/2} \times \text{Sample Interval}} \times \text{Frequency}$$

**WARRANTED  
SPECIFICATIONS  
(Continued)**

All other Measurements:

N = number of measurements averaged.

$$\pm \frac{150 \text{ ps rms} + (1.4 \times \text{Trigger Error})}{\text{Sample Interval} \times \sqrt{N}} \times \text{Frequency}$$

Accuracy:

$$\pm \text{Resolution} \pm (\text{Time Base Aging} \times \text{Frequency}).$$

**Period**

**RANGE**

Single Channel Measurements:

Channels A and B: 2 ns to 8.0 s [131 μs].

Channel C: 0.5 ns to 10 ns.

Dual Channel Measurements:

Channels A and B: 2 ns to 4.0 s [65 μs].

Channel C: 0.5 ns to 10 ns.

**FOR A SINGLE MEASUREMENT**

Least Significant Digit Displayed:

$$\pm \frac{200 \text{ ps}}{\text{Sample Interval}} \times \text{Period}$$

Resolution:

$$\pm \frac{150 \text{ ps rms} + (1.4 \times \text{Trigger Error})}{\text{Sample Interval}} \times \text{Period}$$

Accuracy:

$$\pm \text{Resolution} \pm (\text{Time Base Aging} \times \text{Period}).$$

**MEAN ESTIMATION FOR AVERAGED MEASUREMENTS**

rms Resolution:

Continuous Measurements (Number of Measurements per Block ≥ 3):

$$\frac{\sqrt{13.5} \times (150 \text{ ps rms} + (1.4 \times \text{Trigger Error}))}{(\text{Number of Blocks})^{1/2} \times (\text{Number of Measurements per Block})^{3/2} \times \text{Sample Interval}} \times \text{Period}$$

All other Measurements:

N = number of measurements averaged.

$$\pm \frac{150 \text{ ps rms} + (1.4 \times \text{Trigger Error})}{\text{Sample Interval} \times \sqrt{N}} \times \text{Period}$$

Accuracy:

$$\pm \text{Resolution} \pm (\text{Time Base Aging} \times \text{Period}).$$



## MEASUREMENT UNCERTAINTY DEFINITIONS

### Least Significant Digit, Resolution, and Accuracy

All measured values have associated uncertainties. The following are definitions of terms used to describe these uncertainties. For frequency and time interval measurements and other specific implementations (i.e. rise time, pulse width, duty cycle, etc.) this measurement uncertainty is composed of three factors: Least Significant Digit (LSD), Resolution, and Accuracy.

*Least Significant Digit* is the smallest incremental value displayed in a measurement. The LSD for the HP 5372A is 200 ps, therefore, the smallest displayed increment that two single-shot time interval measurements will differ by is 200 ps.

*Resolution* is the smallest difference in measurements that the instrument can discern. Measurement resolution is of primary concern when comparing data gathered by a single instrument; in other words, the meaning of results when compared against one another. Resolution describes uncertainty due to random effects, including short-term oscillator stability, trigger error, and the internal noise of the instrument itself. Since these effects are random, the resolution uncertainty is specified on an rms basis rather than a peak value. The time interval single-shot resolution of the HP 5372A is 150 ps rms. Resolution can also be improved by averaging single measurements, or in the case of frequency and period measurements, by increasing the measurement gate time as well as averaging measurements.

*Accuracy* is defined to be the combination of random uncertainties and systematic or bias uncertainties in a measurement. Accuracy is of primary concern when comparing data in an absolute sense, such as one production test station to the next. Systematic uncertainties include differential channel delay, long term drift or time base oscillator aging, and Trigger Level Timing Error. These uncertainties may be measured and removed from subsequent measurement data by subtracting the measured bias. Two methods are available to do this with the HP 5372A:

- 1) the Set Reference feature for each input channel, or
- 2) the HP J06-59992A Time Interval Calibrator.

Accuracy = Random Errors + Systematic Errors

**OPERATING  
CHARACTERISTICS**  
(Continued)

**Arm Delay Outputs  
1 and 2**

A falling edge indicates the completion of the arming condition.

Delay: 30 ns.

Output Level: Falling edge active, TTL levels into  $\geq 10\text{ k}\Omega$ .  $>1\text{ V}$  to  $0\text{ V}$  into  $50\Omega$ .

**Inhibit Input**

Input Level Range:  $-2\text{ V}$  to  $5\text{ V}$ .

Minimum Pulse Height:  $200\text{ mV}$  pk-pk.

Impedance:  $10\text{ k}\Omega$  shunted by  $<100\text{ pF}$ .

Setup Time: The inhibit signal must be enabled  $>25\text{ ns}$  prior to the input transition to be inhibited.

Hold Time: The inhibit signal must be enabled  $>10\text{ ns}$  after the input transition to be inhibited.

Maximum Repetition Rate:  $10\text{ MHz}$ .

**TI Detect Output**

The TI Detect output will remain TTL low for the entire period of time the measurements are outside the specified range.

Level: Falling edge active, TTL levels into  $\geq 10\text{ k}\Omega$ .  $>1\text{ V}$  (minimum) to  $0\text{ V}$  into  $50\Omega$ .

Minimum Pulse Width:  $50\text{ ns}$ .

Measurement to TI Detect Output Delay:  $<600\text{ ns}$ .

overview .....	10-2
with TI Detect .....	10-7
Preset key .....	6-9
Preset settings .....	6-9
Print key .....	6-16
printing a list of results .....	12-3
probe calibration .....	D-1

## R

Random Sampling	
± Time Interval .....	1-44
Time Interval .....	1-25
rear panel	
Arm Delay outputs .....	6-25
Gate outputs .....	6-21
Inhibit input .....	6-28
TI Detect output .....	6-28
Rear Panel Features .....	6-32
Recall key .....	6-8
storage registers .....	11-2
reference value .....	9-9
Repetitive auto trigger .....	8-5
Repetitive Edge	
± Time Interval .....	1-41
Continuous Time Interval .....	1-33
Time Interval .....	1-24
Repetitive Edge-Parity	
± Time Interval .....	1-42
resolution, frequency .....	2-8
Response timeout .....	12-4
Restart key .....	6-5
Result Display .....	15-2
Result/Statistics Display .....	15-5
Rise Time function .....	3-14
RMS statistical formula .....	9-4
RMT LED .....	6-4
Root Allan Variance statistical formula .....	9-4

## S

Sample Arm .....	5-17
Sample, definition .....	2-2
Sampling, definition .....	2-3
Save key .....	6-8

saved instrument parameters .....	11-3
storage registers .....	11-2
scale .....	9-7
scroll keys .....	6-15
Separate inputs .....	8-2
serial number .....	Intro-4
service manual .....	Intro-4
Shift key .....	6-16
Show Graph	
Histogram .....	16-25
Single auto trigger .....	8-5
Single auto trigger mode .....	8-4
Single/Repet key .....	6-5
softkeys .....	6-15
Span .....	4-25
Special-Purpose Measurements, description .....	3-1
specifications .....	Intro-4
SRQ LED .....	6-4
Standard Deviation statistical formula .....	9-4
Start .....	4-25
Start Arm .....	5-19
Static error messages, definition .....	C-2
Static failure messages, definition .....	C-2
Static status messages, definition .....	C-1
Statistics .....	9-2
Histogram .....	16-26
Statistics Display .....	15-5
output sequence .....	15-5
Statistics maximum	
Histogram .....	16-27
Statistics mean	
Histogram .....	16-27
Statistics minimum	
Histogram .....	16-27
Statistics standard deviation	
Histogram .....	16-27
Stats mode, graphics .....	16-11
Status key .....	6-16
Status message descriptions .....	C-3
Status messages	
Abort only allowed in Single .....	C-3
Acquiring measurement data .....	C-3
Arming has changed. ....	C-4
Arming parameter changed. ....	C-4
Arming value changed by Fast Meas mode. ....	C-4
Arming, input parameters changed. ....	C-4



description .....	B-8
device address .....	12-2
interconnections .....	B-6
Talk Only mode .....	12-2
Talk/Listen mode .....	12-2
verification program .....	17-60
Hysteresis feature, purpose .....	8-11

## I

"1" .....	15-3
increased bin capacity .....	4-15
Inhibit	
and Arming .....	10-10
and graph data .....	10-11
and measurement results .....	10-11
and Pre-trigger .....	10-11
and Time Variation .....	16-54
Inhibit input .....	6-28
Input pod characteristics .....	8-8
inputs, front panel .....	6-18
Interval Sampling	
± Time Interval .....	1-38
Continuous Time Interval .....	1-32
Frequency/Period .....	2-20
Phase .....	3-26
Phase Deviation .....	3-35
Time Deviation .....	3-37
Time Interval .....	1-23
Totalize .....	3-6
intervals .....	5-17
invalid measurement .....	16-5

## K

knob .....	6-15
------------	------

## L

Last value key .....	6-3
Limit Lines	
Histogram .....	16-37
Time Variation .....	16-53
Limit Status Display .....	15-5

Limits .....	9-8
line voltage selection .....	B-3
Linear Autoscaling	
Histogram .....	16-33
Linear Manual Scaling	
Histogram .....	16-34
Local key .....	6-4
Log Autoscaling	
Histogram .....	16-35
Log Manual Scaling	
Histogram .....	16-36
Log or Linear scale	
Histogram .....	16-33
low frequency measurements .....	8-9
LSN LED .....	6-4

## M

Manual	
Totalize .....	3-12
Manual arm key .....	6-5
Manual Scaling	
Event Timing .....	16-59
Time Variation .....	16-48
manual trigger .....	8-4
manuals supplied .....	Intro-3
marker to maximum	
Histogram .....	16-27
Time Variation .....	16-45
marker to minimum	
Histogram .....	16-28
Time Variation .....	16-45
Marker values	
Event Timing .....	16-57
Histogram .....	16-26
Time Variation .....	16-40
math operators .....	9-6
Mean statistical formula .....	9-2
measurement memory	
1 block, all results saved .....	7-8
multiple blocks, all results saved .....	7-10
multiple blocks, averaged results saved .....	7-14
multiple blocks, not all results saved .....	7-12
multiple blocks, pre-trigger results .....	7-18
single block, pre-trigger results .....	7-17



Phase Deviation ..... 3-35  
 Time Deviation ..... 3-37  
 Time Interval ..... 1-20

Edge Sampling  
 Frequency/Period ..... 2-24  
 Totalize ..... 3-7

Edge/Cycle  
 Frequency/Period ..... 2-28

Edge/Edge  
 Frequency/Period ..... 2-27  
 Totalize ..... 3-9

Edge/Event  
 $\pm$  Time Interval ..... 1-47  
 Frequency/Period ..... 2-30

Edge/Interval  
 $\pm$  Time Interval ..... 1-45  
 Continuous Time Interval ..... 1-34  
 Frequency/Period ..... 2-25  
 Phase ..... 3-27  
 Phase Deviation ..... 3-35  
 Time Deviation ..... 3-38  
 Time Interval ..... 1-26  
 Totalize ..... 3-8

Edge/Parity  
 $\pm$  Time Interval ..... 1-49

Edge/Random  
 $\pm$  Time Interval ..... 1-55  
 Time Interval ..... 1-27

Edge/Time  
 Frequency/Period ..... 2-26

Enter key ..... 6-3  
 ENTRY/MARKER ..... 6-15  
 Error -303, Response timeout occurred. .... C-13  
 Error 105, Alternate Timebase selected. Press  
 RESTART. .... C-3  
 Error 120, HP 5371A Graphics command no  
 longer used. .... C-10  
 Error 180, WARNING: Frequency too high for  
 auto-trigger. .... C-16  
 Error 181, WARNING: Frequency too low for  
 auto-trigger. .... C-16  
 Error 182, WARNING: Both frequencies out of  
 auto-trigger range. .... C-16  
 Error message descriptions ..... C-3  
 Error messages  
 Error -100: Unrecognized command. .... C-6

Error -120: Numeric Argument error. .... C-6  
 Error -151: Query not allowed. Binary format. .C-6  
 Error 102: Bus conflict: Talk-only. .... C-7  
 Error 150: Parameter conflict. .... C-9  
 Error messages, static defined ..... C-2  
 Error queue query command ..... C-2  
 Event Data ..... 2-1  
 Event Holdoff  
 Continuous Time Interval ..... 1-31  
 Frequency/Period ..... 2-19  
 Time Interval ..... 1-22

Event Timing Graph  
 Data Pt ..... 16-57  
 Delta ..... 16-57  
 Manual Scaling ..... 16-59  
 Marker values ..... 16-57  
 overview ..... 16-55  
 Pixel ..... 16-57  
 preset values ..... 16-59  
 saved parameters ..... 16-60  
 Zoom In ..... 16-58  
 Zoom Out ..... 16-58

Event/Event  
 $\pm$  Time Interval ..... 1-53  
 Frequency/Period ..... 2-38

Event/Interval  
 Frequency/Period ..... 2-36

Exp (exponent) key ..... 6-3  
 expanded data ..... 15-3  
 gate time ..... 15-3  
 External Arm input, damage level ..... 6-18  
 External Arm Level ..... 8-7  
 external frequency standard input ..... 6-21  
 Externally Gated  
 Frequency/Period ..... 2-40  
 Totalize ..... 3-10

## F

## Failure messages

Alternate Timebase selected. Press  
 RESTART. .... C-3  
 Error 107: Timebase unlocked. Press  
 RESTART. .... C-7  
 Error 108: Ch A and B Overvoltage. .... C-7





- Phase Deviation ..... 3-35
  - Time Deviation ..... 3-37
  - Time Interval ..... 1-20
  - Edge Sampling
    - Frequency/Period ..... 2-24
    - Totalize ..... 3-7
  - Edge/Cycle
    - Frequency/Period ..... 2-28
  - Edge/Edge
    - Frequency/Period ..... 2-27
    - Totalize ..... 3-9
  - Edge/Event
    - ± Time Interval ..... 1-47
    - Frequency/Period ..... 2-30
  - Edge/Interval
    - ± Time Interval ..... 1-45
    - Continuous Time Interval ..... 1-34
    - Frequency/Period ..... 2-25
    - Phase ..... 3-27
    - Phase Deviation ..... 3-35
    - Time Deviation ..... 3-38
    - Time Interval ..... 1-26
    - Totalize ..... 3-8
  - Edge/Parity
    - ± Time Interval ..... 1-49
  - Edge/Random
    - ± Time Interval ..... 1-55
    - Time Interval ..... 1-27
  - Edge/Time
    - Frequency/Period ..... 2-26
  - Enter key ..... 6-3
  - ENTRY/MARKER ..... 6-15
  - Error -303, Response timeout occurred. .... C-13
  - Error 105, Alternate Timebase selected. Press  
RESTART. .... C-3
  - Error 120, HP 5371A Graphics command no  
longer used. .... C-10
  - Error 180, WARNING: Frequency too high for  
auto-trigger. .... C-16
  - Error 181, WARNING: Frequency too low for  
auto-trigger. .... C-16
  - Error 182, WARNING: Both frequencies out of  
auto-trigger range. .... C-16
  - Error message descriptions ..... C-3
  - Error messages
    - Error -100: Unrecognized command. .... C-6
    - Error -120: Numeric Argument error. .... C-6
    - Error -151: Query not allowed. Binary format. .C-6
    - Error 102: Bus conflict: Talk-only. .... C-7
    - Error 150: Parameter conflict. .... C-9
  - Error messages, static defined ..... C-2
  - Error queue query command ..... C-2
  - Event Data ..... 2-1
  - Event Holdoff
    - Continuous Time Interval ..... 1-31
    - Frequency/Period ..... 2-19
    - Time Interval ..... 1-22
  - Event Timing Graph
    - Data Pt ..... 16-57
    - Delta ..... 16-57
    - Manual Scaling ..... 16-59
    - Marker values ..... 16-57
    - overview ..... 16-55
    - Pixel ..... 16-57
    - preset values ..... 16-59
    - saved parameters ..... 16-60
    - Zoom In ..... 16-58
    - Zoom Out ..... 16-58
  - Event/Event
    - ± Time Interval ..... 1-53
    - Frequency/Period ..... 2-38
  - Event/Interval
    - Frequency/Period ..... 2-36
  - Exp (exponent) key ..... 6-3
  - expanded data ..... 15-3
    - gate time ..... 15-3
  - External Arm input, damage level ..... 6-18
  - External Arm Level ..... 8-7
  - external frequency standard input ..... 6-21
  - Externally Gated
    - Frequency/Period ..... 2-40
    - Totalize ..... 3-10
- F**
- Failure messages
    - Alternate Timebase selected. Press  
RESTART. .... C-3
    - Error 107: Timebase unlocked. Press  
RESTART. .... C-7
    - Error 108: Ch A and B Overvoltage. .... C-7

Error 109: Ch A Overvoltage. ....	C-7
Error 110: Ch B Overvoltage. ....	C-8
Error 111: Power-down before removing pods. ....	C-8
Error 160: Out of sensitivity cal. ....	C-9
Failure messages, static defined .....	C-2
Fall Time function .....	3-16
Fast Measurement Mode .....	12-5
frequency and period measurements .....	2-6
time interval measurements .....	1-3
FastPort option .....	6-29
features, instrument .....	Intro-2
Firmware revision number .....	12-6
Floating Point result format .....	12-3
Following the block arming condition .....	5-17
Following the block arming sequence .....	5-18
Following the Delay Ref edge .....	5-22
Following the start arming edge .....	5-20
Frequency	
Averaged Results .....	2-15
"T" .....	14
measurement range .....	9
measurements referenced to the holdoff	
edge .....	14
single-channel choices .....	11
two-channel choices .....	11
frequency measurements	
arming mode summary .....	13
frequency standard .....	1
external input .....	1
output .....	6-21
frequency, resolution .....	2-8
Front Panel Features .....	6-31
front panel inputs .....	6-18
fuse selection .....	B-3

G

GATE LED .....	6-5
Gate outputs .....	6-21
gate time	
expanded data .....	15-3
Grid	
Histogram .....	16-24
Time Variation .....	16-39
growing Histogram .....	16-30

H

Histogram Graph	
Delta .....	16-26
Grid .....	16-24
growing Histogram .....	16-30
Limit Lines .....	16-37
Linear Autoscaling .....	16-33
Linear Manual Scaling .....	16-34
Log Autoscaling .....	16-35
Log Manual Scaling .....	16-36
Log or Linear scale .....	16-33
marker to maximum .....	16-27
marker to minimum .....	16-28
Marker values .....	16-26
Outline .....	16-25
overview .....	16-22
preset values .....	16-59
saved parameters .....	16-60
Show Graph .....	16-25
Statistics .....	16-26
Statistics maximum .....	16-27
Statistics mean .....	16-27
Statistics minimum .....	16-27
Statistics standard deviation .....	16-27
Update .....	16-29
View Channel .....	16-32
Zoom In .....	16-28
Zoom Out .....	16-28
Histogram measurements .....	4-1
a setup where bins would not overflow .....	4-8
Big Bin .....	4-15
Bin Overflow .....	4-5
Bin Width .....	4-25
Center .....	4-25
description .....	4-3
Numeric Results .....	4-27
Span .....	4-25
Start .....	4-25
total number of measurements .....	4-8
Holdoff/Sampling Modes .....	5-48
HP-IB	
address selection .....	B-8
addressing mode .....	12-2
configuration .....	12-2
connector .....	6-20

# Index

## A

A & B	
Frequency/Period .....	2-11
Totalize .....	3-3
A + B	
Frequency/Period .....	2-12
Totalize .....	3-4
A / B	
Frequency/Period .....	2-11
Totalize .....	3-3
A - B	
Frequency/Period .....	2-12
Totalize .....	3-4
abort a measurement .....	6-6
Abort function .....	6-6
accessories available .....	Intro-3
accessories supplied .....	Intro-3
Allen Variance statistical formula .....	9-4
Arm a block of measurements .....	5-16
Arm Delay outputs .....	6-25
Arm each measurement .....	5-19
Arm sampling on meas channel .....	5-17
arm the end of each measurement .....	5-20
Arming	
and Inhibit .....	10-10
Arm a block of measurements .....	5-16
Arm each measurement .....	5-19
Arm sampling on meas channel .....	5-17
arm the end of each measurement .....	5-20
Automatic arming mode .....	5-24
Automatic Mode .....	5-9
Block Holdoff .....	5-16
continuous/non-continuous .....	5-3, 5-5, 5-8
Count (events) .....	5-20
Cycle Sampling arming mode .....	5-36
definition .....	5-2
Delay (time or events) .....	5-21
Edge Holdoff arming mode .....	5-26
Edge Sampling arming mode .....	5-38
Edge/Cycle arming mode .....	5-54

Edge/Edge arming mode .....	5-52
Edge/Event arming mode .....	5-56
Edge/Interval arming mode .....	5-48
Edge/Parity arming mode .....	5-58
Edge/Random arming mode .....	5-60
Edge/Time arming mode .....	5-50
Event Holdoff arming mode .....	5-30
Event/Event arming mode .....	5-68
Event/Interval arming mode .....	5-66
Externally Gated arming mode .....	5-70
Following the block arming condition .....	5-17
Following the block arming sequence .....	5-18
Following the Delay Ref edge .....	5-22
Following the start arming edge .....	5-20
function and arming mode summary table ...	5-12
Holdoff Modes .....	5-9, 5-26
Holdoff/Sampling Modes .....	5-10
Interval Sampling arming mode .....	5-32
intervals .....	5-17
Manual arming mode .....	5-72
measurements referenced to the holdoff	
edge .....	5-22
Parity Sampling arming mode .....	5-40
Random Sampling arming mode .....	5-46
Repetitive Edge arming mode .....	5-42
Repetitive Edge-Parity arming mode .....	5-44
Sample Arm .....	5-17
Sampling Modes .....	5-10, 5-31
screen terms defined .....	5-15
Start Arm .....	5-19
Stop Arm .....	5-20
Time Holdoff arming mode .....	5-28
Time Sampling arming mode .....	5-33
Time/Interval arming mode .....	5-62
Time/Time arming mode .....	5-64
ASCII result format .....	12-3
attenuation .....	8-9
attenuation caution .....	8-10
auto trigger	
Repetitive .....	8-5
Single .....	8-5

- Automatic
  - ± Time Interval ..... 1-36
  - Continuous Time Interval ..... 1-28
  - Frequency/Period ..... 2-16
  - Phase ..... 3-26
  - Phase Deviation ..... 3-35
  - Time Deviation ..... 3-37
  - Time Interval ..... 1-19
- Autoscaling
  - Event Timing ..... 16-59
  - Time Variation ..... 16-48
- Averaged Results ..... 7-14
  - Continuous Time Interval ..... 1-18
  - Frequency/Period ..... 2-15
  - Phase Deviation ..... 3-31
  - Time Deviation ..... 3-31
  - Time Variation ..... 16-50
- ± TI ..... 1-1
- ± Time Interval
  - measurement range ..... 1-

**B**

- Back space key ..... 6-3
- bias level ..... 8-8
- Big Bin ..... 4-11
- Bin Overflow ..... 4-5
- Bin Width ..... 4-25
- Binary result format ..... 12-4
- Block Averaging
  - Time Variation ..... 16-49, 16-50
- Block Holdoff ..... 5-16
- Block, definition ..... 2-7
- Bold Display ..... 15-6

**C**

- calibration for 10:1 probe ..... D-1
- Cancel Copy function ..... 6-16
- Carrier Frequency ..... 3-32, 3-36
- Center ..... 4-25
- Channel A and Channel B inputs, damage
  - level ..... 6-18
- Channel C input, damage level ..... 6-19

- clock
  - setting ..... 12-6
- Command
  - error queue query ..... C-2
- Common inputs ..... 8-2
- Connect Data
  - Time Variation ..... 16-39
- Continuous Time Interval
  - "T" ..... 1-13, 1-17
  - Averaged Results ..... 1-18
  - measurement range ..... 1-4
  - measurements referenced to the holdoff
    - edge ..... 1-17
    - missed events ..... 1-13 - 1-14
- Count (events) ..... 5-20
- CTI ..... 1-1
- CURSOR/SCROLL ..... 6-15
- Cycle Sampling
  - Frequency/Period ..... 2-22

**D**

- Data Pt ..... 16-13
  - Event Timing ..... 16-57
  - Time Variation ..... 16-44
- Default Meas Setup function ..... 6-11
- Delay (time or events) ..... 5-21
- Delta
  - Event Timing ..... 16-57
  - Histogram ..... 16-26
  - Time Variation ..... 16-41
- Delta mode ..... 16-10
- Delta results ..... 16-11
- diagnostic tests ..... 13-2
- display concealment ..... 12-6
- Duty Cycle function ..... 3-22

**E**

- "E" ..... 15-3
- Edge Holdoff
  - ± Time Interval ..... 1-37
  - Continuous Time Interval ..... 1-29
  - Frequency/Period ..... 2-17
  - Phase ..... 3-26

**EXAMPLE  
MEASUREMENTS  
AND UNCERTAINTY  
CALCULATIONS  
(Continued)**

**ECL Edge-to-Edge,  
or Single-Period  
Measurement**

A single-shot period measurement is made from falling edge to falling edge of a ECL signal. The input signal has 1 mV rms of noise with a fall time of 2.5 ns over an 800 mV swing. The HP 54002A 50Ω input pod is used with a -2 volt termination. The measured value is 10.0 ns. It has been 1 month since the HP 5372A time base has been calibrated.

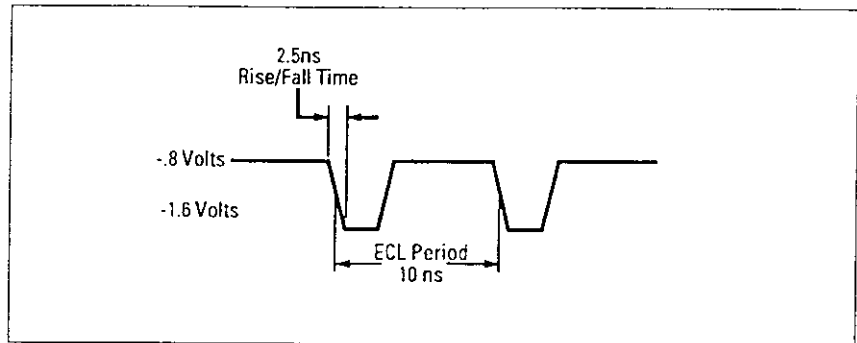

*Measurement uncertainty example using Time Interval to measure from falling edge to falling edge of an ECL signal.*

Least Significant Digit Displayed:

= ± 200 ps

Resolution:

= ± 150 ps rms ± Start Trigger Error ± Stop Trigger Error

$$= \pm 150 \text{ ps rms} \pm \frac{\sqrt{(200 \text{ } \mu\text{V rms})^2 + (1 \text{ mV rms})^2}}{0.32 \text{ V/ns}} \pm \frac{\sqrt{(200 \text{ } \mu\text{V rms})^2 + (1 \text{ mV rms})^2}}{0.32 \text{ V/ns}}$$

= ± 156 ps rms

Accuracy:

= ± Resolution ± (Time Base Aging x Pulse Width) ± Trigger Level Timing Error ± 1 ns Systematic Error

$$= \pm 156 \text{ ps rms} \pm (5 \times 10^{-10} \times 30 \text{ days} \times 10 \text{ ns}) \pm \left[ \left( \frac{22.5 \text{ mV}}{0.32 \text{ V/ns}} - \frac{22.5 \text{ mV}}{0.32 \text{ V/ns}} \right) \pm \frac{24 \text{ mV}}{0.32 \text{ V/ns}} \pm \frac{24 \text{ mV}}{0.32 \text{ V/ns}} \right] \pm 1 \text{ ns Systematic Error}$$

= ± 1.31 ns

**EXAMPLE  
MEASUREMENTS  
AND UNCERTAINTY  
CALCULATIONS  
(Continued)**

Note that a major portion of the measurement accuracy consists of the 1 ns systematic term. This can be reduced to less than 10 ps with careful calibration using the HP J06-59992A Time Interval Calibrator.

**ECL Frequency  
Measurement**

A Frequency measurement is made on a 100 MHz ECL signal with a 1 μs sample interval. The signal has 1 mV of noise with a transition time of 2.5 ns over an 800 mV swing. The HP 54002A 50Ω input pod is used with a -2 volt termination. It has been 1 month since the HP 5372A time base has been calibrated.

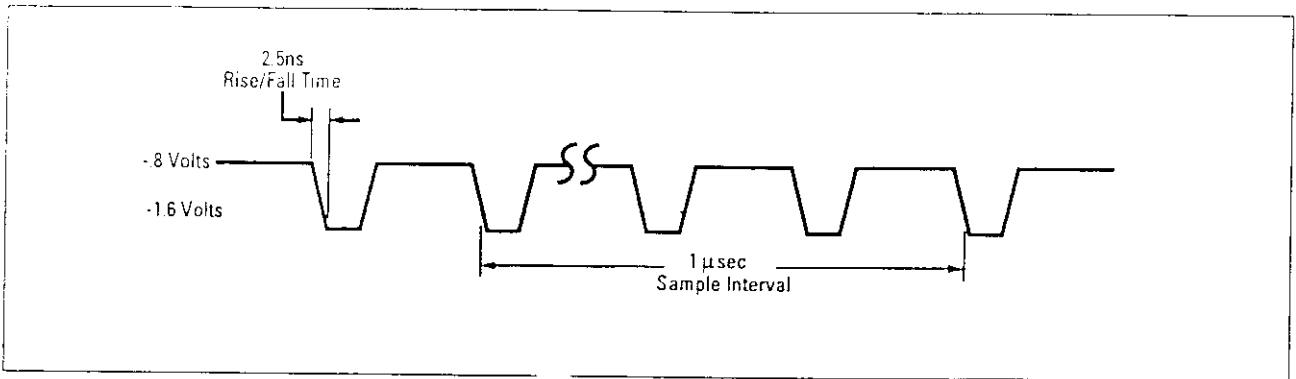

Measurement uncertainty example for a Frequency measurement on an ECL signal.

Least Significant Digit Displayed:

$$= \pm \frac{10 \text{ ps}}{\text{Sample Interval}} \times \text{Frequency}$$

$$= \pm \frac{2}{1 \mu\text{s}} \times 100 \text{ MHz}$$

$$= \pm 20 \text{ kHz}$$

Resolution:

$$= \pm \frac{150 \text{ ps rms} + (1.4 \times \text{Trigger Error})}{\text{Sample Interval}}$$

$$= \pm \frac{150 \text{ ps rms} + (1.4 \times \frac{\sqrt{(200 \mu\text{V rms})^2 + (1 \text{ mV rms})^2}}{0.32 \text{ V/ns}})}{1 \mu\text{s}} \times 100 \text{ MHz}$$

$$= \pm 15.4 \text{ kHz}$$

Accuracy:

$$= \pm \text{Resolution} \pm (\text{Time Base Aging} \times \text{Frequency})$$

$$= \pm 15.4 \text{ kHz} \pm (5 \times 10^{-10} \times 30 \text{ days} \times 100 \text{ MHz})$$

$$= \pm 15.4 \text{ kHz}$$

**MEASUREMENT  
UNCERTAINTY  
DEFINITIONS  
(Continued)**

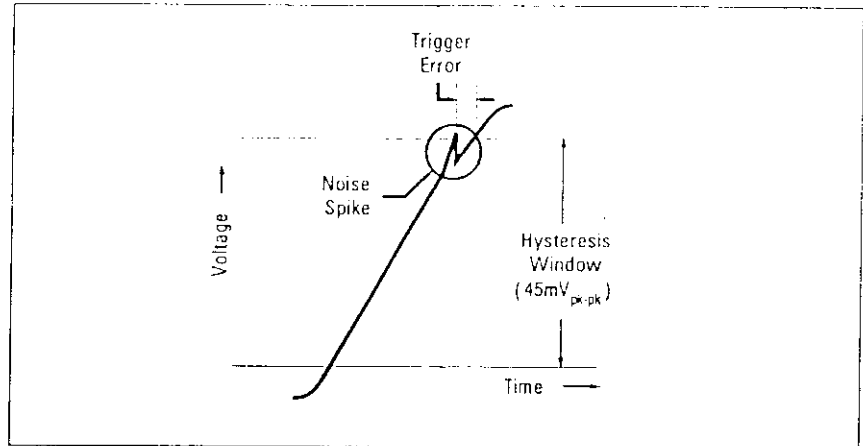

*Trigger Error is due to noise on the input signal. Here a noise spike causes an 'early' trigger.*

Trigger Level Timing Error is a systematic uncertainty due to the input hysteresis of the HP 5372A. Trigger Level Timing Error is a constant value for any particular signal and slew rate, but the effects will vary with amplitude and slew rate. Trigger Level Timing Error can be minimized by maintaining as high an input signal slew rate as possible, and can be removed by careful calibration with the HP J06-59992A Time Interval Calibrator.

$$\text{Trigger Level Timing Error} = \left( \frac{0.5 \times \text{Hysteresis Window}}{\text{Start Input Signal Slew Rate}} - \frac{0.5 \times \text{Hysteresis Window}}{\text{Stop Input Signal Slew Rate}} \right) \pm \frac{\text{Trigger Level Accuracy (start)}}{\text{Start Input Signal Slew Rate}} \pm \frac{\text{Trigger Level Accuracy (stop)}}{\text{Stop Input Signal Slew Rate}}$$

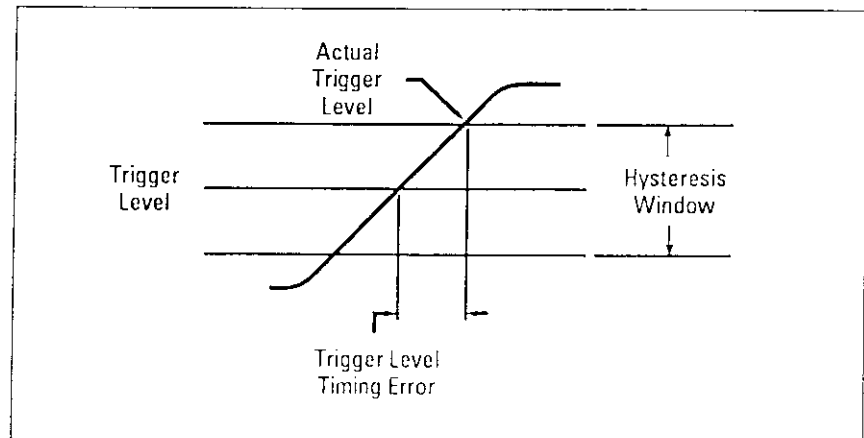

*Trigger Level Timing Error is a systematic uncertainty. It is constant for any particular signal slew rate.*

**EXAMPLE  
MEASUREMENTS  
AND UNCERTAINTY  
CALCULATIONS**

The following are measurement examples to illustrate the use of the measurement uncertainty equations for typical measurement applications. In these examples, the specific values have been entered into the complete equation. In practice, the associated graphs of these equations can be used to determine various uncertainties.

**TTL Pulse Width  
Measurement**

A single-shot Pulse Width measurement is made with a value of 100.0 ns. The signal has 10 mV rms (28 mV<sub>pk-pk</sub>) noise, a rise time of 20 ns, and a fall time of 10 ns over a 3 volt swing. The measurement is made using the HP 54003A 1 MΩ input pod with a 10:1 divider probe. It has been 1 month since the HP 5372A time base has been calibrated.

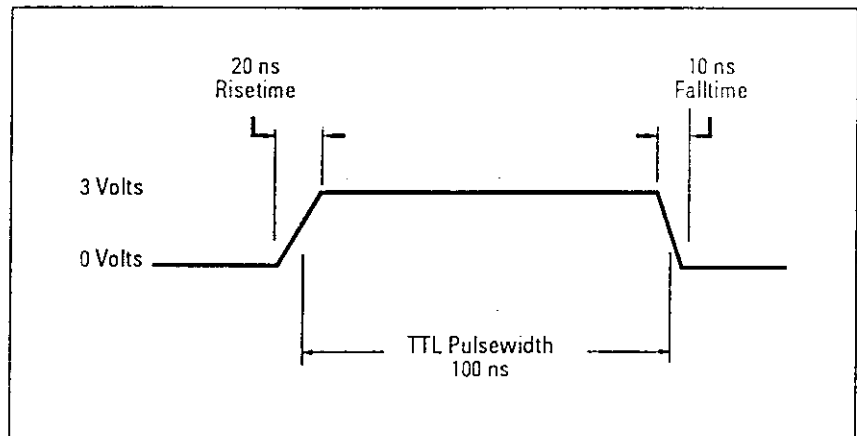

*TTL Pulse Width measurement uncertainty example.*

Least Significant Digit Displayed:

$$= \pm 200 \text{ ps}$$

Resolution:

$$= \pm 150 \text{ ps rms} \pm \text{Start Trigger Error} \pm \text{Stop Trigger Error}$$

$$= \pm 150 \text{ ps rms} \pm \frac{\sqrt{(200 \text{ } \mu\text{V rms})^2 + (10 \text{ mV rms})^2}}{15 \text{ V}/\mu\text{s}} \pm \frac{\sqrt{(200 \text{ } \mu\text{V rms})^2 + (10 \text{ mV rms})^2}}{30 \text{ V}/\mu\text{s}}$$

$$= \pm 1.15 \text{ ns rms}$$

Accuracy:

$$= \pm \text{Resolution} \pm (\text{Time Base Aging} \times \text{Pulse Width}) \pm \text{Trigger Level Timing Error} \pm 1 \text{ ns Systematic Error}$$

$$= \pm 1.15 \text{ ns rms} \pm (5 \times 10^{-10} \times 30 \text{ days} \times 100 \text{ ns}) \pm \left[ \left( \frac{22.5 \text{ mV}}{15 \text{ V}/\mu\text{s}} - \frac{22.5 \text{ mV}}{30 \text{ V}/\mu\text{s}} \right) \pm \frac{21.5 \text{ mV}}{15 \text{ V}/\mu\text{s}} \pm \frac{21.5 \text{ mV}}{30 \text{ V}/\mu\text{s}} \right]$$

$\pm 1 \text{ ns Systematic Error}$

$$= \pm 3.62 \text{ ns}$$